

THE WERKZEUG

WGB







INHALT

CONTENT



—
WERKZEUGAUFBEWAHRUNG
TOOL STORAGE **01**

—
SCHRAUBENSCHLÜSSEL
SPANNERS **02**

—
STIFTSCHLÜSSEL
KEY WRENCHES **03**

—
STECKSCHLÜSSEL-EINSÄTZE
BETÄTIGUNGSWERKZEUGE, GARNITUREN
SOCKETS & ACCESSORIES, SOCKET SETS **04**

—
DREHMOMENTWERKZEUGE
TORQUE TOOLS **05**

—
SCHRAUBENDREHER
SCREWDRIVERS **06**

—
ZANGEN
PLIERS **07**

—
VERSCHIEDENE WERKZEUGE
MISCELLANEOUS TOOLS **08**

—
VDE WERKZEUGE
VDE TOOLS **09**

—
FUNKENFREIES WERKZEUG
NON-SPARKING SAFETY TOOLS **10**

—
PROFESSIONELLES HANDWERKZEUG
ZUM BASISPREIS
PROFESSIONAL HANDTOOLS PLUS BASIC PRICES **11**

WIRKLICH GUTE BUDDIES THE CREED



**THE
WERKZEUG
WAGEN**

WGB

GET THINGS
FERTIG!



Wir entwickeln und fertigen unsere Werkzeuge für die, die täglich die Dinge am Laufen halten und für dort, wo gutes Werkzeug einfach verlässlich zum Einsatz kommt. Und da wir selbst schon weit über 100 Jahre produzieren und benutzen, was wir verkaufen, stehen die Buchstaben unseres Namens für eine Schmiede mit deutscher Präzisionsarbeit — da kommen wir her!

Dabei könnte die Interpretation von WGB aber treffender formuliert werden: Wirklich Gute Buddies. Denn unsere Werkzeuge sind, wie auch wir selbst, einfach gute Helfer. WGB THE WERKZEUG ist die in Stahl gegossene Muskelkraft — die packt, greift und einfach lange lebt.

We develop and manufacture our tools for people who keep things running every day, wherever good tools need to be used reliably and easily. And since we have been producing and using the tools we sell ourselves for more than 100 years, the initials in our name are synonymous with a forge that offers German precision work — these are our origins!

The initials WGB could be interpreted even more accurately as Wonderfully Good Buddies. After all, our tools are like us: really good at helping out. WGB THE WERKZEUG is muscle power forged in steel — to grab, grip and last a long time.



**GET
THINGS
FERTIG.**



EISEN IS OUR DNA.

1910 als Westfälische Stollen- und Schraubenfabrik Breckerfeld gegründet, wird das Unternehmen ein Jahr später zunächst unter dem Signet WSB im Kaiserlichen Handelsregister eintragen — als Hersteller von Eisenwaren für den täglichen Bedarf der Landbevölkerung.

Mit fortschreitender Industrialisierung wurde in den 1930-er Jahren ein neuer Produktionszweig von eisernen Gebrauchsgegenständen aufgegriffen. Es wurden erste Schraubenschlüssel unter neuem Namen Westfälische Gesenkschmiede Breckerfeld (WGB) gefertigt. 30 Jahre später entwickelten wir auf Basis unser langjährigen Schmiedeerfahrung und unter Einsatz moderner Technik den Standard des bis heute gültigen Schraubenschlüsselmodells. Seit 1989 sind wir als WGB Familienmitglied in der „VONZITZEWITZ-Gruppe“ zusammen mit unserem Schwesterunternehmen Carl Walter, welches seinen Stamm- und Fertigungssitz in Wuppertal hat. Damit sind wir von Tag eins bis heute „Mittelstand in Familienhand“!

Heute — 110 Jahre nach Gründung — positionieren wir uns als Know-How-Spezialist mit einem umfangreichen Qualitätswerkzeugsortiment für alle Verschraubungen. Regelmäßige Marktanalysen, der Dialog mit unseren Kunden und Geschäftspartnern sowie fachliche und unternehmerische Weiterentwicklung gewährleisten die Fähigkeit zur Anpassung an Marktgegebenheiten und an spezifische Kundenanforderungen. Auch in Zukunft.

Founded in 1910 as the Westphalian stud and screw factory Breckerfeld, the company was first registered under the name WSB in the imperial trade register one year later — as a manufacturer of hardware for the daily use of the rural population.

As industrialization progressed, a new production branch for iron implements was launched in the 1930s. The first spanners were produced under the new name Westfälische Gesenkschmiede Breckerfeld (Westphalian drop forge Breckerfeld, WGB). 30 years later, WGB used its long forging experience and modern technology to develop the standard spanner model that has prevailed to this day. Since 1989 we at WGB belong to the "VONZITZEWITZ Group" family alongside our affiliate Carl Walter with its headquarters and production site in Wuppertal. From day one until the present day we have always been a mid-sized family company!

Today — 110 years after its founding — the company positions itself as an expertise specialist with an extensive range of quality tools for all fittings. Regular market analysis, dialogue with customers and business partners along with technical and corporate development ensure the ability to adapt to market situations and specific customer requests. Both now and in the future.



SEIT 1345



VON ZITZEWITZ GRUPPE

Die Werkzeugfamilie.

SEIT 1910

SEIT 1919

WGB[®]

WALTER
WERKZEUGE





**LET IT
FUN—
KELN.**



THE TOOLTORIALS TOOLBOX TV



Unser Antrieb ist es, Werkzeuge immer raffinierter zu machen. Und um zu zeigen, was die neuesten Entwicklungen unserer Schmiede sind, haben wir unseren eigenen Kanal ins Leben gerufen: Toolbox TV.

We are driven to make our tools increasingly sophisticated. And to show you the latest developments from our forge, we have launched our own channel: Toolbox TV.

Westfälische Gesenkschmiede GmbH
Toolbox TV mit Peter Kohl und Dominik Schwind

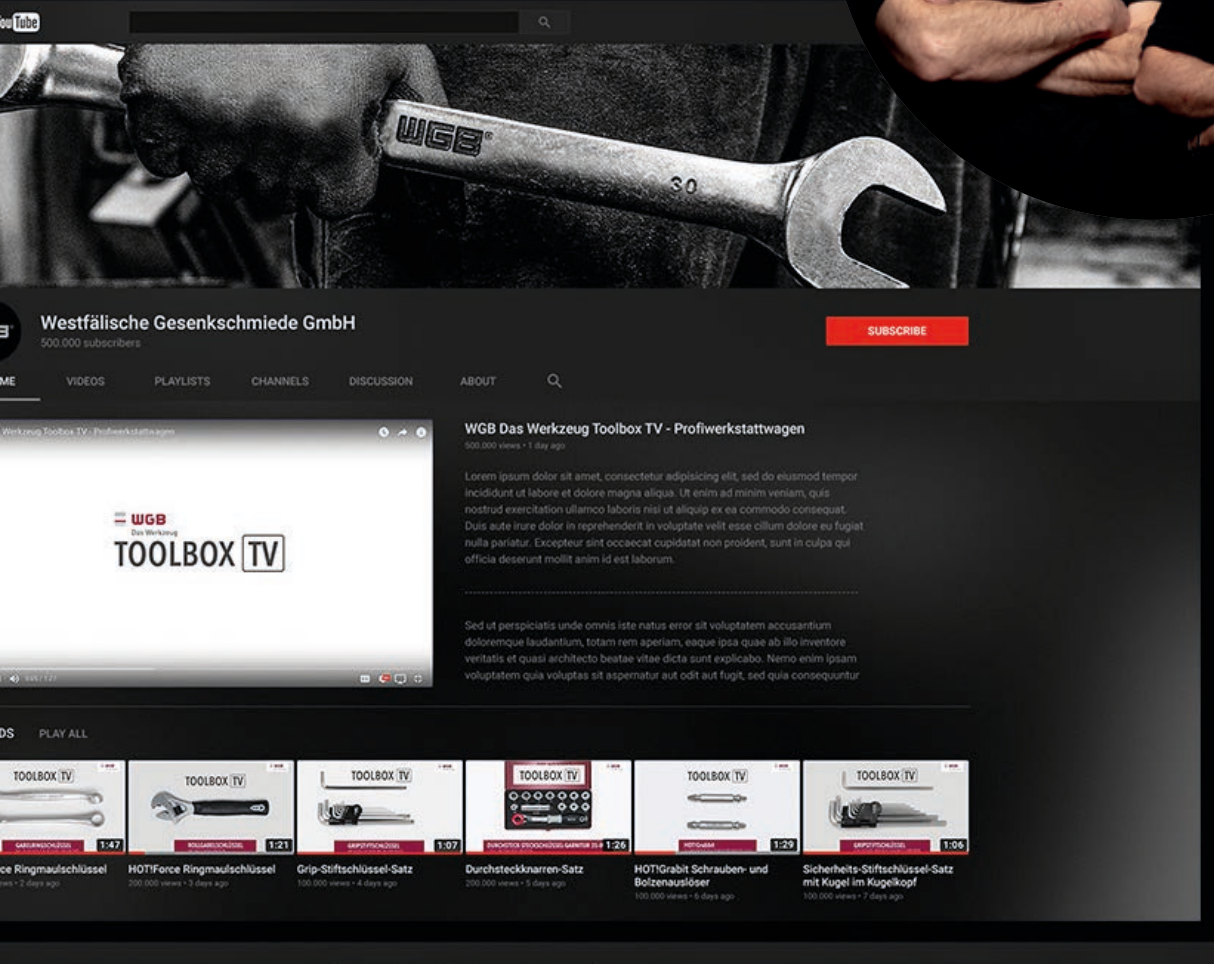



WGB The Werkzeug Toolbox TV - Profiwerkstattwagen



WGB The Werkzeug Toolbox TV - Grip-Stiftschlüssel-Satz

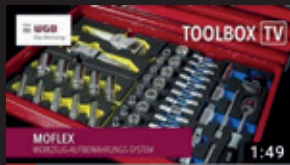

WGB The Werkzeug Toolbox TV - MOFLEX - flexible Module



WGB The Werkzeug Toolbox TV - Sicherheits-Stiftschlüssel-Satz mit Kugel im Kugelkopf



WGB The Werkzeug Toolbox TV - HOT!Force Ringmaulschlüssel



WGB The Werkzeug Toolbox TV - Durchsteckknarren-Satz



WGB The Werkzeug - Toolbox TV - Rollgabelschlüssel mit Ratschenfunktion



WGB The Werkzeug Toolbox TV - Durchsteck-Doppelring-schlüssel-Satz



WGB The Werkzeug Toolbox TV - Rotationsknarre

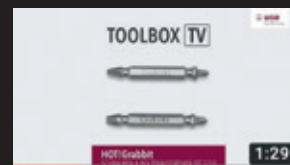

WGB The Werkzeug Toolbox TV - HOT!Grabit Schrauben- und Bolzenauslöser

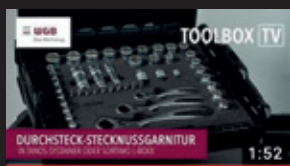

WGB The Werkzeug Toolbox TV - 137-in-1 Durchsteckgarnitur

QR-Code scannen und schauen!

KONTAKT

CONTACT

ARNO VERHOOG
Geschäftsführer
Managing Director

t +49 (0) 2338 . 9199-38
f +49 (0) 2338 . 9199-487

verhoog@wgb-werkzeuge.de

HUBERTUS VON ZITZEWITZ
Geschäftsführender Gesellschafter
Managing Director

t +49 (0) 2338 . 9199-12
f +49 (0) 2338 . 9199-100

vonzitzewitz@wgb-werkzeuge.de

IRIS JOSCH
Vertriebsinnendienst
Sales Assistant

t +49 (0) 2338 . 9199-16
f +49 (0) 2338 . 9199-316

josch@wgb-werkzeuge.de

ANDREA KRAMER
Vertriebsinnendienst
Sales Assistant

t +49 (0) 2338 . 9199-465
f +49 (0) 800 . 88 90 90 9 (kostenfrei!)

kramer@wgb-werkzeuge.de

BÄRBEL MÖLLER
Vertriebsinnendienst
Sales Assistant

t +49 (0) 2338 . 9199-47
f +49 (0) 2338 . 9199-314

moeller@wgb-werkzeuge.de

DANIELA SPÖRLEIN
Vertriebsinnendienst
Sales Assistant

t +49 (0) 2338 . 9199-461
f +49 (0) 800 . 88 90 90 9 (kostenfrei!)

spoerlein@wgb-werkzeuge.de

SEBASTIAN BAIER
Vertriebsinnendienst
Sales Assistant

t +49 (0) 2338 . 9199-462
f +49 (0) 800 . 88 90 90 9 (kostenfrei!)

baier@wgb-werkzeuge.de

PETER HUGEL
Leitung Einkauf
Purchase Manager

t +49 (0) 2338 . 9199-18
f +49 (0) 2338 . 9199-40

hugel@wgb-werkzeuge.de

ANDREAS LANGE
Leitung Qualitätssicherung/
tech. Vertriebsassistent
Technical Sales Assistant

t +49 (0) 2338 . 9199-30
f +49 (0) 2338 . 9199-482

lange@wgb-werkzeuge.de

PETER KOHL
Leitung Versand/Logistik & POS-Teams
Warehouse and Logistics Manager &
POS-Teams

t +49 (0) 2338 . 9199-20
f +49 (0) 2338 . 9199-485

kohl@wgb-werkzeuge.de

SO FINDEN SIE UNS HOW TO FIND US

Breckerfeld liegt zentral im Dreieck der Autobahnen A1, A45 und A46 und ist ca. 10 km von Hagen und 36 km von Dortmund entfernt.

Breckerfeld is in the centre between motorways A1, A45 and A46, appr. distance from Hagen 10 km, from Dortmund 36 km.

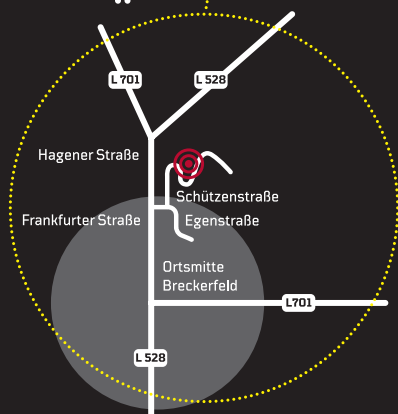
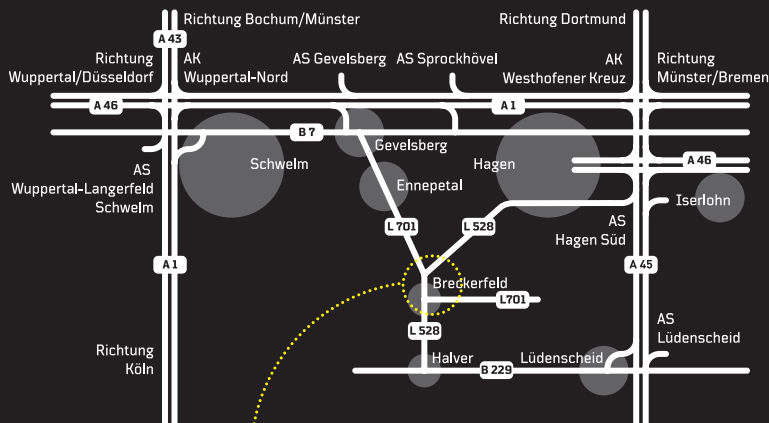

UNSERE VERTRETUNGEN OUR REPRESENTATIONS



DIN

QUALITÄT.

Strenge Qualitätskontrollen garantieren höchste Produktqualität oberhalb der DIN- und ISO-Standardnormen. Vorgeschriebene Belastungswerte übertreffen wir aus Prinzip.

QUALITY.

Strict quality controls guarantee best product quality above the DIN and ISO standards. We are beating mandatory load values as a matter of principle.



GARANTIE.

Im Bedarfsfall gewährleisten wir jederzeit eine schnelle Reklamationsbearbeitung. Unser umfassendes Garantieverprechen findest du auf den Seiten 00 | 20 und 00 | 21 dieses Kataloges.

WARRANTY.

If need be we are granting quick processing of complaints at any time. Our comprehensive guarantee promise can be found on pages 00 | 20 and 00 | 21 of this catalog.



%

PREISGESTALTUNG.

Unsere Produkte stehen für nachhaltige Wertschöpfung bei einem unangefochtenen Preis-/Leistungsverhältnis.

PRICING.

WGB products stand for sustainable added value at an unbeatable price-performance ratio.



LIEFERZEITEN.

Just-in-Time-Lieferung bei uns heißt: Bis 15 Uhr bestellte Ware bringen wir noch am selben Tag auf den Weg. Bei Bedarf unterstützen wir deine individuelle Logistik auch durch Streckenversand.

DELIVERY TIMES.

Just-in-time-deliveries from WGB means: goods ordered until 3 p.m. will be shipped on the same day. If need be we will support your individual logistics as well with direct dispatch.



SERVICE.

Wir bieten mehr als verlässliche Garantien, reibungslose Logistik und seriösen Reklamationservice. Barcode-basierte Inventur-systeme, Private-Label-Kennzeichnung und individuelle POS Lösungen sind inklusive.

SERVICE.

WGB offers more than reliable warranties, smooth logistics and reliable service in case of a complaint, barcode based inventory systems, private labels and individual POS-solutions are included.



POS-SUPPORT.

Darauf kannst du dich verlassen: Verkaufstrainings und maßgeschneiderte VKF-Aktionen helfen beim Hard-Selling. Hinzu kommen kostenlose Produktmuster, Verkaufshilfen wie Displays und Prospekte, Verkaufsförderungs- und kundenindividuelle Werbemittel.

POS-SUPPORT.

You can rely on this as our trading partner: Hard selling is supported by sales training and customized sales increasing campaigns. In addition to that we offer free product samples, sales aid like displays and brochures, sales-promotional and individual advertising material.



**THE WERKZEUG.
TRUST
THE FIRMA.**

**WGB TOOLS.
AN ANCHOR OF
TRUST.**

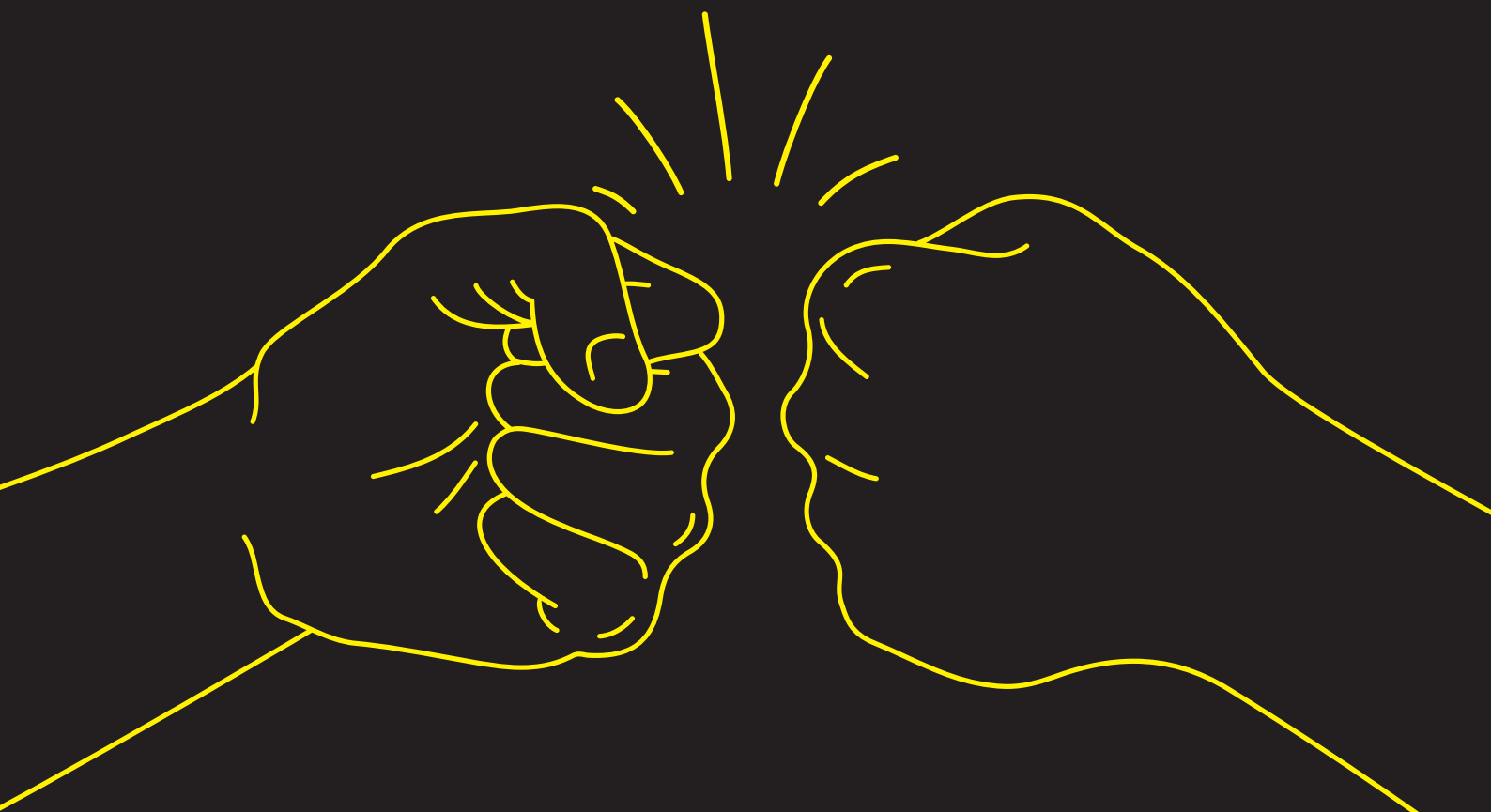



HERSTELLERGARANTIE DER Westfälischen Gesenkschmiede GmbH

Für ein Produkt der Marke WGB THE WERKZEUG gelten die jeweils aktuellen gesetzlichen Gewährleistungsregelungen. Darüber hinaus ersetzt WGB für einen Zeitraum von 40 Jahren (gerechnet ab Kaufdatum des Werkzeugs) im Falle eines Herstellungs- oder Materialmangels des Werkzeugs dieses kostenfrei durch ein fehlerfreies Werkzeug.

Im Garantiefall ist das betroffene Werkzeug zusammen mit dem Original-Kaufbeleg an unsere Firmenadresse zu senden. Der Kaufbeleg muss das Kaufdatum und die Produktbezeichnung enthalten.

Ob ein Herstellungs- oder Materialmangel vorliegt, wird von einem unabhängigen Prüfinstitut geprüft. Dieses Prüfergebnis ist bindend. Ersetzte Werkzeuge gehen in unser Eigentum über.

Die Garantie deckt alle Mängel des Produkts während der Garantiezeit ab, die auf Herstellungs- oder Materialfehler zum Zeitpunkt des Kaufs zurückzuführen sind. Die Garantie ist auf den Ersatz beschränkt und beinhaltet keine anderen Verpflichtungen.

Die Garantie gilt nicht in folgenden Fällen: Bei einer unsachgemäßen oder nicht bestimmungsgemäßen Benutzung des Werkzeugs, bei einer Veränderung oder Modifizierung des Werkzeugs, bei einer Nichtbeachtung von Bedienungshinweisen sowie für normale Abnutzungserscheinungen und den gebrauchstüblichen Verschleiß des Werkzeugs. Die Garantie endet, sobald das Werkzeug aus Gründen, die nicht auf einen Material- oder Herstellungsfehler zurückzuführen sind, unbrauchbar wird.

Die Ersatzlieferung im Rahmen dieser Garantie ist kostenfrei. Sie stellt weder eine Verlängerung noch einen Neubeginn der Garantiezeit dar.

Die Garantie gilt für innerhalb der europäischen Union gekaufte Produkte.

Mängelhaftungsansprüche, die der Käufer durch den Kaufvertrag gegenüber dem Verkäufer hat, sowie die gesetzlichen Rechte werden durch diese Garantie nicht eingeschränkt.

MANUFACTURER WARRANTY OF Westfälische Gesenkschmiede GmbH

For a product of the brand WGB THE WERKZEUG the current statutory warranty regulations apply. In addition, WGB will replace the tool by a tool free of defect of charge for a period of 40 years (calculated from the date of purchase) in case of a manufacturing or material defect of the tool.

In case of warranty, the affected tool must be sent together with the original invoice of purchase to our company address. The invoice of purchase must contain the date of purchase and the product name.

Defective tools will become our property for test purposes. An independent testing institute will check if there is a production or material defect. The test result is valid.

The warranty covers all defects in the product during the warranty period due to manufacturing or material defects at the time of purchase. The warranty is limited to replacement and contains no other obligations.

The warranty does not apply in the following cases: In case of inappropriate or improper use of the tool, if the tool was modified, if instructions are disregarded, if normal and use-related tear and wear of the tool occur. The warranty ends as soon as the tool becomes unusable for reasons that are not due to a defect in material or production.

The replacement delivery under this warranty is free of charge. It constitutes neither an extension nor a restart of the warranty period.

The warranty is valid for products purchased within the European Union.

Liability claims that the buyer has against the seller as a result of the purchase agreement, as well as the legal rights, are not limited by this guarantee.

Im Garantiefall wenden Sie sich bitte an /
In the case of a warranty, please contact

Westfälische Gesenkschmiede GmbH
Schützenstr. 26-28 — D-58339 Breckerfeld

Tel: +49 (0) 2338 . 9199-0 — E-Mail: info@the-werkzeug.de

HERSTELLERGARANTIE DER Westfälischen Gesenkschmiede GmbH

Für ein Produkt der Marke WGB BASIC gelten die jeweils aktuellen gesetzlichen Gewährleistungsregelungen. Darüber hinaus ersetzt WGB für einen Zeitraum von 10 Jahren (gerechnet ab Kaufdatum des Werkzeugs) im Falle eines Herstellungs- oder Materialmangels des Werkzeugs dieses kostenfrei durch ein fehlerfreies Werkzeug.

Im Garantiefall ist das betroffene Werkzeug zusammen mit dem Original-Kaufbeleg an unsere Firmenadresse zu senden. Der Kaufbeleg muss das Kaufdatum und die Produktbezeichnung enthalten.

Ob ein Herstellungs- oder Materialmangel vorliegt, wird von einem unabhängigen Prüfinstitut geprüft. Dieses Prüfergebnis ist bindend. Ersetzte Werkzeuge gehen in unser Eigentum über.

Die Garantie deckt alle Mängel des Produkts während der Garantiezeit ab, die auf Herstellungs- oder Materialfehler zum Zeitpunkt des Kaufs zurückzuführen sind. Die Garantie ist auf den Ersatz beschränkt und beinhaltet keine anderen Verpflichtungen.

Die Garantie gilt nicht in folgenden Fällen: Bei einer unsachgemäßen oder nicht bestimmungsgemäßen Benutzung des Werkzeugs, bei einer Veränderung oder Modifizierung des Werkzeugs, bei einer Nichtbeachtung von Bedienungshinweisen sowie für normale Abnutzungserscheinungen und den gebrauchstüblichen Verschleiß des Werkzeugs. Die Garantie endet, sobald das Werkzeug aus Gründen, die nicht auf einen Material- oder Herstellungsfehler zurückzuführen sind, unbrauchbar wird.

Die Ersatzlieferung im Rahmen dieser Garantie ist kostenfrei. Sie stellt weder eine Verlängerung noch einen Neubeginn der Garantiezeit dar.

Die Garantie gilt für innerhalb der europäischen Union gekaufte Produkte.

Mängelhaftungsansprüche, die der Käufer durch den Kaufvertrag gegenüber dem Verkäufer hat, sowie die gesetzlichen Rechte werden durch diese Garantie nicht eingeschränkt.

MANUFACTURER WARRANTY OF Westfälische Gesenkschmiede GmbH

The current statutory warranty regulations apply to products of the WGB THE TOOL brand. In addition, WGB will replace a defective tool free of charge for a period of 40 years (calculated from the date of purchase of the tool) in the event of a manufacturing or material defect of the tool.

In the event of a warranty claim, the affected tool must be sent to our company address together with the original proof of purchase. The proof of purchase must contain the date of purchase and the product designation.

Whether a manufacturing or material defect exists will be checked by an independent testing institute. This test result is binding. Replaced tools become our property.

The warranty covers all defects in the product during the warranty period that are due to manufacturing or material defects at the time of purchase. The warranty is limited to replacement and does not include any other obligations.

The warranty does not apply in the following cases: In the event of improper or unintended use of the tool, alteration or modification of the tool, failure to follow operating instructions, and normal wear and tear of the tool. The warranty ends as soon as the tool becomes unusable for reasons that cannot be attributed to a material or manufacturing defect.

Replacement under this warranty is free of charge. It is neither an extension nor a restart of the warranty period.

The warranty applies to products purchased within the European Union.

Claims for liability for defects that the buyer has against the seller under the purchase contract, as well as statutory rights, are not limited by this warranty.

Im Garantiefall wenden Sie sich bitte an /
In the case of a warranty, please contact

Westfälische Gesenkschmiede GmbH
Schützenstr. 26-28 — D-58339 Breckerfeld

Tel: +49 (0) 2338 . 9199-0 — E-Mail: info@the-werkzeug.de

KUNDE IST KING. KING CUSTOMER.

Für unsere Fachhändler bieten wir eine Vielzahl von Produktpräsentationen am POS. Von kleinsten Aktionspräsentationen bis zu kompletten Systemwänden.
Es besteht auch immer die Möglichkeit von individuellen Lösungen nach Kundenwunsch. Unser POS-Team findet für jede Anforderung die richtige Lösung. Alle Produkte werden fertig konfektioniert nach Kundenwunsch geliefert.

WGB offers a variety of product presentations at the POS. From the smallest presentations for promotions all the way to complete system walls.
Individual solutions based on customer requests are always an option. Our POS team will find the right solution for every requirement. All products are fully assembled and delivered according to the customer's request.



EXKLUSIV, ZUVERLÄSSIG, KUNDENORIENTIERT.

Bei WGB verbinden sich exklusiver Markenauftritt, attraktive Verkaufsförderungsmaßnahmen und zuverlässige Logistikleistungen zu einem überzeugenden Servicepaket. Ausgehend von zehn Jahren Garantie, gewährleisten wir im Reklamationsfall jederzeit eine schnelle Bearbeitung.

Ein global vernetzter Warenfluss mit festen Handelsvertretungen in allen Teilen Europas, Lateinamerikas, den arabischen Ländern und Asien stellt die Logistik auf eine sichere Basis und garantiert kurze Lieferfristen. Bis 15 Uhr bestellte Ware versenden wir noch am selben Tag.





DAS MODULARE WGB-WANDSYSTEM

Zentraler Bestandteil unserer Verkaufsförderungsmaßnahmen in den Märkten sind die WGB-Verkaufswände. Sie sind modular aufgebaut und können beliebig erweitert werden. Innerhalb jedes Elements lassen sich verschiedene Sortimentsbereiche individuell kombinieren.

Alle Artikel sind auf Wunsch mit Fähnchenetikett oder SB-Karte lieferbar, welche neben der Artikelinformation einen scannerfähigen EAN-Code aufweisen.

Zusätzlich gibt es die klare Garantieaussage direkt am Werkzeug: 40 Jahre Intensiv Garantie.

Für unsere Sales Promotion entwickeln wir abgestimmte Sonder- und Partneraktionen mit attraktiven Anreizsystemen. Dazu zählt auch die Bereitstellung wirkungsvoller Displays und kundenindividueller Werbemittel.



EXCLUSIVE, RELIABLE, CUSTOMER-ORIENTED.

At WGB, an exclusive brand image, attractive sales promotion measures and reliable logistics services are combined to form a convincing service package. Starting with ten year's warranty, WGB guarantees rapid help at all times in the event of a complaint. A globally networked flow of goods with permanent commercial representatives in all parts of Europe, Latin America, Arab countries and Asia, places logistics on a sound basis and guarantees short delivery times. Goods ordered by 3:00 pm are despatched on the same day.

THE MODULAR WGB WALL SYSTEM

WGB Wall Systems are a central component of our sales promotion measures in markets. They have a modular design and can be extended as required. A variety of product ranges can be combined individually inside each element.

All articles are provided with labels containing not only product information but also a scannable barcode.

The additional clear guarantee statement direct on the tool "40 years intensive warranty" is important for your customers – and therefore also for your sales.

We develop coordinated special and partner campaigns with attractive incentive systems for our Sales Promotion. This also includes the provision of effective displays and individual customer advertising materials.





**MAKE
IT GANZ
GENAU.**

CUSTOMIZE ZUM GUTEN PRICE.

CUSTOMIZED TOOLS AT A GOOD PRICE.



WGB im Dienst der Marke

Wir bieten unseren Handelspartnern vielfältige Dienstleistungen für den eigenen Markenauftritt – von individuellen Verpackungs- und Kennzeichnungslösungen bis zu kompletten Warensortimenten mit Private-Label-Ausstattung. Alle Katalogartikel können wir (entsprechende Mindestfertigungsmengen vorausgesetzt) mit deinen Eigen- und Handelsmarken kennzeichnen.

PRIVATE LABEL XL

Neutrale Warensätze in Verkaufsverpackungen mit deiner Marke, deinem Design, deiner Etikettierung und Umverpackung, sonstigen Verpackungs- und Logistikvorschriften und deinen Vorgaben für Qualitäts- und Normierungsvorschriften (z. B. Produktsicherheit, Umwelt- und Gesundheitsnormen, Verpackungsverwertung etc.).

PRIVATE LABEL XXL

Alle Artikel mit deinem Markenlogo gekennzeichnet (geprägt, gerollt, gestempelt, gelasert u. a.). Produktfinishes (z. B. bei der Verchromung) oder Produktfarben (z. B. für Mehrkomponenten-Kunststoffgriffe) können individuell abgestimmt und umgesetzt werden.

Weitere Dienstleistungen ergänzen unser Angebot:

Konfektionierungsservice für

- Erstausrüstung und Beigabewerkzeuge
- Werkzeugsets
- POS-Präsentationen (Erst- und Zweitplatzierung)

Professioneller Datenservice

- Verfügbarkeit aller Daten aus medienneutraler Datenbank in allen gängigen Formaten
- Verfügbarkeit sämtlicher Artikeldaten einschließlich Bilder für deine Print- und Digitalwerbemittel und deinen Online-Shop
- Elektronischer Datenaustausch (z. B. im EDIFACT-Format)

Umfangreicher Logistik-Service zu deinen Schnittstellen

- Umsetzung deiner Volumen- und Gewichtsspezifikationen für Umverpackungen und Lademittel
- Umsetzung von Vorgaben zur Unterstützung der internen Logistik
- Etikettenerstellung von gelieferten Daten in allen gängigen Formaten
- Direktversand im Streckengeschäft
- Einbindung deiner Logistikpartner in unsere Supply-Chain
- Just-in-time-Anlieferung

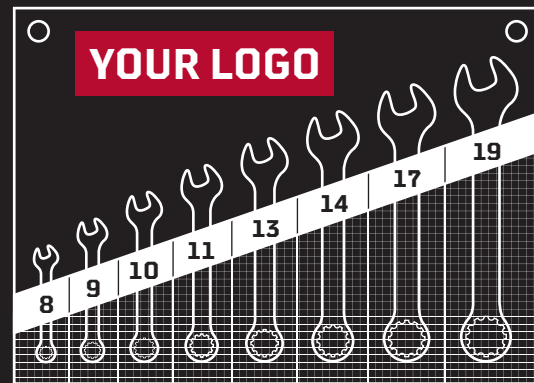
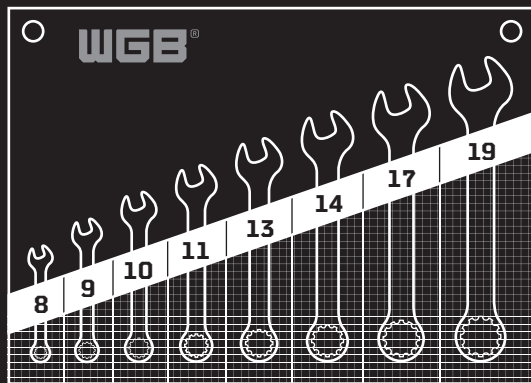

SO EASY GEHT'S

- | | | | | | | |
|--|---|--|---|---|---|--------------------------------------|
| <p>1. WGB Werkzeug/
Zubehör aussuchen</p> | → | <p>2. Eigenes Logo senden,
Farben und Schriften
angeben</p> | → | <p>3. Fotovisual
freigeben</p> | → | <p>4. Bestellen — Fertig!</p> |
| <p>1. WGB Tool/
Choose accessories</p> | → | <p>2. Send your own logo,
indicate colors and
fonts</p> | → | <p>3. Approve
photo visual</p> | → | <p>4. Order — Done!</p> |

WGB at your brand's service

WGB offers its trade partners a wide range of services for their own brand identity – from individual packaging and marking solutions to complete assortment ranges fitted with private labels. We can provide all catalogue articles with your proprietary brands and trademarks – on condition of corresponding minimum order quantities.

PRIVATE LABEL XL

Neutral product sets in sales packaging with your brand, your design, your labelling and outer packaging, other packaging and logistics regulations and your specifications for quality and standardization regulations (e.g. product safety, environmental and health standards, packaging recycling etc.)

PRIVATE LABEL XXL

All articles marked with your brand logo (embossed, rolled, stamped, lasered etc.). Product finish (e.g. with chrome plating) or product colours (e.g. for multi-component plastic handles) can be coordinated and implemented individually.

Our range is supplemented by further services:

Confectioning service sets

- Original equipment and additional tools
- Tool sets
- POS presentations (first and second placement)

Professional data service

- Availability of all data from media-neutral databases in all standard formats
- Availability of all article data including images for your print and digital advertising materials and your online shop
- Electronic data exchange [e.g. in EDIFACT format]

Comprehensive logistics service for your interfaces

- Implementation of your volume and weight specifications for packaging and loading equipment
- Implementation of requirements to support your internal logistics
- Label production with supplied data in all standard formats
- Direct dispatch for direct-to-customer business
- Inclusion of your logistics partners in our supply chain
- Just-In-Time delivery



THE SONDER- WERKZEUGE. THINK IT WEITER.

19 20 21 22 23





SPECIAL TOOLS. THINK FURTHER.

INDIVIDUELL, EINZIGARTIG, BESONDERS.

Wir bieten dir sämtliche Handwerkzeuge aus unserem Sortimentsbereiche auch als Sonderausführungen nach deinem Wunsch an. Auf der Basis von Mustern, technischen Zeichnungen oder anderen Angaben erstellen wir dir ein auf deinen Bedarf zugeschnittenes Angebot.

Folgende Fertigungsoptionen stehen dir zur Verfügung:

- Individuelle Werkzeugformen und -griffe
- Qualitätsstähle in Sonderlegierungen
- Griffe aus besonderen Werkstoffen
- Individuelle Produktfinishes, z. B. galvanische Oberflächenveredelung, farbige Lackierung
- Individuelle Produktfarben, z. B. für Ein- und Mehrkomponenten-Kunststoffgriffe

Für Bearbeitungsschritte, die wir selbst nicht ausführen können, arbeiten wir mit langjährigen Partnern aus unserem Netzwerk zusammen. Alle Sonderanfertigungen werden im Rahmen unseres Qualitätsmanagementsystems mit der gleichen Sorgfalt kontrolliert wie unsere Katalogartikel.

Weitere Leistungen wie „private labelling“, Konfektionierung und unsere kundenspezifischen Logistikkdienste findest du auf Seite 00 | 26 und 00 | 27 dieses Katalogs.

Unsere Ingenieure beraten dich gerne bei der Planung von Sonderteilen. Sie helfen bei der technischen Optimierung und können auf Wunsch Alternativen aufzeigen. Gerne besuchen sie dich auch vor Ort.

INDIVIDUAL, UNIQUE, SPECIAL.

WGB also offers all tools from its product ranges as special design according to customer requirements. The products are manufactured tailor-made to suit your requirements on the basis of samples, technical drawings or other details.

You can choose from the following production options:

- Individual tool forms and handles
- Quality steel in special alloys
- Handles made of special materials
- Individual product finishes, e.g. galvanic surface finishing, colour paint surfaces
- Individual product colours, e.g. for single and multicomponent plastic handles

In the case of processing stages that we are unable to carry out ourselves, we have partners within our network with whom we have been working together for many years. All special designs are checked as part of our quality management system with the same care and attention as our catalogue articles.

Other services such as “private labelling”, packing and our customer-related logistics services can be found on page 00 | 26 and 00 | 27 of this catalogue.

Let our engineers advise you on the planning of special parts. They can help you with technical optimisation and also suggest alternatives on request — which we will also be happy to carry out on your premises.

FOTOINDEX PHOTO INDEX

01	 01 4-01 7	 01 8-01 17	 01 18-01 25	 01 26-01 38	 01 39	 01 40-01 43	 01 44-01 45
02	 02 2-02 3	 02 4-02 15	 02 16-02 19	 02 19-02 20	 02 21-02 25	 02 26-02 27	 02 28-02 29
 02 30-02 31	 02 31-02 32	 02 33-02 36	 02 34-02 35	03	 03 3-03 5	 03 4-03 5	 03 6-03 7
 03 7	 03 8	 03 9-03 11	 03 9-03 12	04	 04 2-04 4	 04 4-04 6	 04 6-04 8
 04 9	 04 10-04 11	 04 12-04 14	 04 14-04 16	 04 17	 04 18-04 21	 04 22-04 25	 04 25-04 27
 04 28-04 31	 04 32-04 39	 04 32-04 39	 04 46	 04 47	 04 48	 04 49-04 51	 04 52
 04 52-04 53	 04 53	 04 54	 04 57	 04 58-04 59	 04 59-04 63	 04 66-04 67	 04 68-04 69
 04 70	 04 63-04 65	05	 05 2-05 4	 05 4-05 5	 05 6-05 7	06	 06 2-06 3
 06 4-06 9	 06 10-06 11	 06 12-06 13	 06 14	 06 15-06 16	 06 17-06 18	07	 07 2
 07 2	 07 3	 07 3	 07 4	 07 4	 07 5	 07 6	 07 7
 07 8	 07 9	 07 10-07 12	08	 08 2-08 3	 08 3	 08 4-08 5	 08 6
 08 7	 08 8	 08 8	 08 9	 08 10	 08 11	 08 12	 08 13

FOTOINDEX PHOTO INDEX

 08 14-08 15	 08 16	 08 17	 08 18-08 19	 08 20-08 21	 08 22	 08 23	 08 24
 08 24	 08 25	 08 26	 08 27-08 28	09	 09 4-09 5	 09 7	 09 8
 09 8	 09 8	 09 9	 09 9	 09 10	 09 10-09 11	 09 12	10
 10 4	 10 5	 10 5	 10 5	 10 6-10 7	 10 7	 10 8	 10 8-10 9
11	 11 2	 11 3-11 4	 11 5-11 6	 11 7-11 9	 11 9-11 10	 11 11-11 13	 11 14
 11 14	 11 15-11 18	 11 19-11 20	 11 20	 11 21	 11 21-11 22	 11 23-11 24	 11 25-11 26
 11 27	 11 28-11 32	 11 33-11 35	 11 36-11 37	 11 37	 11 38	 11 39-11 41	 11 42
 11 43	 11 44-11 50	 11 51	 11 51	 11 51	 11 52	 11 53	 11 54
 11 55	 11 56	 11 57	 11 58	 11 58-11 59	 11 59	 11 60	 11 61
 11 62	 11 63	 11 64	 11 65	 11 66-11 67	 11 67		

Master	Artikel	Seite
297 KSB	4 in 1 Doppelring-Ratschenschlüssel-Satz	02 25
297	4 in 1 Doppelring-Ratschenschlüssel	02 25
A		
815	Abbrechklinge	08 27
882	Abisolierzange, DIN ISO 5744	07 4
883	Abisolierzange	07 4
9882	Abisolierzange	11 60
801	Aderendhülsenzange	07 7
250	Aufsteck-Ringzugschlüssel	02 30
260	Aufsteckrohr	02 30
421	Autolichtprüfer	08 7
2373	Automatischer Drehmomentschlüssel 1/2"	05 3
2374	Automatischer Drehmomentschlüssel 1/4"	05 2
2395	Automatischer Drehmomentschlüssel 3/4"	05 4
2371	Automatischer Drehmomentschlüssel 3/8"	05 2
9239	Automatischer Drehmomentschlüssel 3/8"	11 53
2389	Auto. Drehmo. für Einsteckwerkzeuge	05 3
9373	Automatischer Drehmomentschlüssel im Set 1/2"	11 53
B		
866	Bandschlüssel	08 5
8661	Bandschlüssel	08 4
9866	Bandschlüssel	11 65
9984	Berliner Maurerhammer	11 67
3351	Bit-Adapter 1/2", DIN 3126	04 23
9051	Bit-Adapter 1/2", DIN 3126	11 42
1351	Bit-Adapter 1/4", DIN 3126	04 4
2522	Bit-Adapter 3/8", DIN 3126	04 12
8883	Bolzenschneider	07 7
823	Breitmaul-Grip-Zange	07 11
1878	Bügelsägebogen, funkenfrei	10 8
D		
804 TD	Display Komfort-Abbrechklingen-Messer	08 27
549 TD	Display Schrauben- und Bolzenausdreher-Set für beschädigte Schrauben	08 26
3980 D	Display Steckschlüssel-Garnituren 1/4" 1/2" 3/4"	04 51
803 TD	Display Universal-Abbrechklingen-Messer	08 27
690	Doppelmaulschlüssel, DIN 3110	02 2
9650	Doppelmaulschlüssel, DIN 895	11 18
9659	Doppelmaulschlüssel, DIN 895	11 17
9690	Doppelmaulschlüssel, DIN 3110	11 3
690 K	Doppelmaulschlüssel-Satz, DIN 3110	02 3
690 RT	Doppelmaulschlüssel-Satz, DIN 3110	02 3
690 S	Doppelmaulschlüssel-Satz, DIN 3110	02 2
9690 K	Doppelmaulschlüssel-Satz, DIN 3110	11 4
9690 RT	Doppelmaulschlüssel-Satz, DIN 3110	11 4
9690 S	Doppelmaulschlüssel-Satz, DIN 3110	11 3
1869	Doppelmaulschlüssel, funkenfrei	10 4
9295	Doppelring-Ratschenschlüssel	11 13
298	Doppelring-Ratschenschlüssel für Durchsteck-Steckschlüssel-Einsätze	04 28
295	Doppelring-Ratschenschlüssel mit Stopring	02 24
295 RT	Doppelring-Ratschenschlüssel-Satz	02 24

Master	Artikel	Seite
9295 RT	Doppelring-Ratschenschlüssel-Satz	11 13
215	Doppelringschlüssel Außen-TORX®-Schrauben	02 20
9215	Doppelringschlüssel Außen-TORX®-Schrauben	11 8
290 K	Doppelringschlüssel-Satz, gekröpft, DIN 838	02 17
290 RT	Doppelringschlüssel-Satz, gekröpft, DIN 838	02 17
290 S	Doppelringschlüssel-Satz, gekröpft, DIN 838	02 16
9290 K	Doppelringschlüssel-Satz, gekröpft, DIN 838	11 8
9290 RT	Doppelringschlüssel-Satz, gekröpft, DIN 838	11 8
9290 S	Doppelringschlüssel-Satz, gekröpft, DIN 838	11 7
210 K	Doppelringschlüssel-Satz, gerade, DIN 837 B	02 18
9240 K	Doppelringschlüssel-Satz, offen, DIN 3118 A	11 10
290	Doppelringschlüssel, gekröpft, DIN 838	02 16
9290	Doppelringschlüssel, gekröpft, DIN 838	11 7
1829	Doppelringschlüssel, gekröpft, funkenfrei	10 4
210	Doppelringschlüssel, gerade, DIN 837 B	02 18
9210	Doppelringschlüssel, gerade, DIN 837 B	11 9
240	Doppelringschlüssel, offen, DIN 3118 A	02 19
9240	Doppelringschlüssel, offen, DIN 3118 A	11 10
9455	Doppelseitiger Rohrsteckschlüssel	11 19
450	Doppelseitiger Rohrsteckschlüssel, DIN 896 B	02 33
455	Doppelseitiger Rohrsteckschlüssel	02 35
9450	Doppelseitiger Rohrsteckschlüssel, DIN 896 B	11 19
450 K	Doppelseitiger Rohrsteckschlüssel-Satz, DIN 896 B	02 33
1893	Drahtbürste, funkenfrei	10 9
785	Drechslerbeitel, DIN 5144	08 23
420	Drehstift	02 36
430	Drehstift	02 36
900	Dreikantfeile	08 20
780	Dreikantholschaber, DIN 8350 C	08 24
1876	Durchschläger, funkenfrei	10 8
376	Durchsteck-Adapter	04 28
518	Durchsteck-Bit-Adapter	04 28
375	Durchsteck-Doppelring-Einsatz	04 28
375/1	Durchsteck-Doppelring-Einsatz	04 28
3970	Durchsteck-Doppelring-Ratschenschlüssel-Satz „28 in 1“ 1/4" 3/8" 1/2"	04 29
371	Durchsteck-Hebelumschaltknarre, 72 Zähne	04 43
378	Durchsteck-Steckschlüssel-Adapter	04 30
382	Durchsteck-Steckschlüssel-Adapter	04 43
383	Durchsteck-Steckschlüssel-Adapter	04 42
366	Durchsteck-Steckschlüssel-Einsatz	04 42
3960	Durchsteck-Steckschlüssel-Garnitur „40 in 1“	04 31
378	Durchsteck-Steckschlüssel-Verlängerung	04 30
381	Durchsteck-Steckschlüssel-Verlängerung	04 42
373	Durchsteckknarre, 72 Zähne	04 30
760	Durchtreiber, DIN 6458	08 16
E		
347	E-TX Schraubendreher-Einsatz 1/2"	04 21
9365	E-TX Schraubendreher-Einsatz 1/2"	11 41
9522	E-TX Schraubendreher-Einsatz 1/4"	11 24
2016	E-TX Schraubendreher-Einsatz 3/8"	04 10
9078	E-TX Schraubendreher-Einsatz 3/8"	11 34

Master	Artikel	Seite
810	Eckrohrzange, DIN 5234	07 9
811	Eckrohrzange, DIN 5234	07 9
812	Eckrohrzange, DIN 5234	07 9
1888	Eckrohrzange, funkenfrei	10 7
9640	Einmaulschlüssel, DIN 894	11 16
9649	Einmaulschlüssel, DIN 894	11 15
280	Einringschlüssel, gerade, DIN 3111	02 31
610	Elektriker-Doppelmaulschlüssel	02 19
734	Elektrikermeißel	08 15
835	Ersatzkette für Ketten-Gripzange	07 12
720	Ersatzkopf	08 13
F		
1891	Halbrundfeile, funkenfrei	10 9
907 K	Feilensatz	08 21
904	Flachfeile	08 21
1890	Flachfeile, funkenfrei	10 9
750	Flachmeißel, DIN 6453	08 14
890	Flachrundzange, DIN ISO 5745	07 3
891	Flachrundzange, DIN ISO 5745	07 4
892	Flachrundzange, DIN ISO 5745	07 3
893	Flachrundzange, DIN ISO 5745	07 4
9890	Flachrundzange, DIN ISO 5745	11 60
9891	Flachrundzange, DIN ISO 5745	11 60
1885	Flachrundzange, funkenfrei	10 6
781	Flachschaber, DIN 8350 A	08 24
1883	Flachzange, funkenfrei	10 6
409	FlexibleMagnetheber	08 7
529	Flexible Verlängerung 1/4"	04 4
9529	Flexible Verlängerung 1/4"	11 25
735	Fugenmeißel	08 15
391	Fühlerlehre	08 7
G		
515	Gelenk-Hakenschlüssel	02 28
516	Gelenk-Hakenschlüssel	02 28
9510	Gelenk-Hebelumschaltknarre 1/4", DIN 3122 D	11 27
511	Gelenk-Teleskop-Hebelumschaltknarre 1/4", 72 Zähne, DIN 3122 D	04 7
2511	Gelenk-Teleskop-Hebelumschaltknarre 3/8", 72 Zähne, DIN 3122 D	04 15
3511	Gelenk-Teleskop-Hebelumschaltknarre 1/2", 72 Zähne, DIN 3122 D	04 26
580	Gelenk-Steckschlüssel	02 20
9580	Gelenk-Steckschlüssel	11 14
365	Gelenkgriff 1/2", DIN 3122 F	04 25
572	Gelenkgriff 1/4", DIN 3122 F	04 6
2321	Gelenkgriff 3/8", DIN 3122 F	04 14
3068	Gerüstbau-Ratsche, 32 Zähne, umschaltbar	04 25
718	Gipserbeil	08 11
354	Griff mit Gleitstück 1/2", DIN 3122 A	04 23
9354	Griff mit Gleitstück 1/2", DIN 3122 A	11 42
506	Griff mit Gleitstück 1/4", DIN 3122 A	04 4
9506	Griff mit Gleitstück 1/4", DIN 3122 A	11 25

Master	Artikel	Seite
442	Griff mit Gleitstück 3/4", DIN 3122 A	04 46
9442	Griff mit Gleitstück 3/4", DIN 3122 A	11 51
2165	Griff mit Gleitstück 3/8". DIN 3122 A	04 12
9075	Griff mit Gleitstück 3/8". DIN 3122 A	11 36
5160	Griff mit Gleitstück 1", DIN 3122 A	04 53
303 KH	Grip-Stiftschlüssel-Satz	03 2
827	Grip-Zange	07 10
936	Gummiaufsatz für Handfäustel	08 12
950	Gummihammer, DIN 5128 A	08 13
9950	Gummihammer, DIN 5128 A	11 68
H		
814	Hakenklinge	08 28
680	Hakenschlüssel	02 29
681	Hakenschlüssel	02 29
903	Halbrundfeile	08 20
906	Halbrundraspel	08 21
935	Handfäustel, DIN 6475	08 12
937	Handfäustel, DIN 6475	08 12
9935	Handfäustel, DIN 6475	11 67
754	Handschutz	08 15
444	Hebelumschaltknarre 3/4", 24 Zähne, DIN 3122 D	04 48
9439	Hebelumschaltknarre 3/4", 24 Zähne, DIN 3122 D	11 51
9366	Hebelumschaltknarre 1/2", 72 Zähne, DIN 3122 D	11 43
3066	Hebelumschaltknarre 1/2", 72 Zähne, gebogener Schaft, DIN 3122 D	04 26
3067	Hebelumschaltknarre 1/2", 72 Zähne, gerader Schaft, DIN 3122 D	04 26
9512	Hebelumschaltknarre 1/4", 72 Zähne, DIN 3122 D	11 27
5012	Hebelumschaltknarre 1/4", 72 Zähne, gebogener Schaft, DIN 3122 D	04 6
5013	Hebelumschaltknarre 1/4", 72 Zähne, gerader Schaft, DIN 3122 D	04 7
9907	Hebelumschaltknarre 3/8", 72 Zähne, DIN 3122 D	11 36
2356	Hebelumschaltknarre 3/8", 72 Zähne, gebogener Schaft, DIN 3122 D	04 15
2357	Hebelumschaltknarre 3/8", 72 Zähne, gerader Schaft, DIN 3122 D	04 15
771	Henkelocheisen, DIN 7200 A	08 22
9771	Henkelocheisen, DIN 7200 A	11 63
771 HK	Henkelocheisen-Satz, DIN 7200 A	08 22
784	Hohlbeitel, DIN 5142	08 23
224	HOT!FORCE Ringmaulschlüssel	02 14
224 K	HOT!FORCE Ringmaulschlüssel-Satz	02 15
224 RT	HOT!FORCE Ringmaulschlüssel-Satz	02 15
726	HSS-Sägeblatt, DIN 6494 A	08 24
I		
829	Ideal-Grip-Zange	07 10
5363	Innensechskant-Kraft-Einsatz 1"	04 66
3363	Innensechskant-Kraft-Einsatz 1/2", 6-kant	04 60
4364	Innensechskant-Kraft-Einsatz 3/4", 6-kant	04 64
3363 KK	Innensechskant-Kraft-Garnitur 1/2"	04 63

Master	Artikel	Seite
3950	Innensechskant-Steckschlüssel-Garnitur 1/2"	04 32
3910	Innensechskant-Steckschlüssel-Garnitur 1/4" 1/2"	04 33
363	Innensechskant-Schraubendreher-Einsatz 1/2", DIN 7422	04 20
501	Innensechskant-Schraubendreher-Einsatz 1/4"	04 3
9363	Innensechskant-Schraubendreher-Einsatz 1/2", DIN 7422	11 40
2051	Innensechskant-Schraubendreher-Einsatz 3/8", DIN 7422	04 11
9501	Innensechskant-Schraubendreher-Einsatz 1/4", DIN 7422	11 24
9902	Innensechskant-Schraubendreher-Einsatz 3/8", DIN 7422	11 35
K		
896	Kabelschere	07 6
880	Kantenzange, DIN ISO 9243	07 6
1881	Kantenzange, funkenfrei	10 7
352	Kardan-Gelenk 1/2", DIN 3123 C	04 22
9352	Kardan-Gelenk 1/2", DIN 3123 C	11 42
509	Kardan-Gelenk 1/4", DIN 3123 C	04 4
9509	Kardan-Gelenk 1/4", DIN 3123 C	11 26
2110	Kardan-Gelenk 3/8", DIN 3123 C	04 12
9906	Kardan-Gelenk 3/8", DIN 3123 C	11 37
833	Ketten-Grip-Zange	07 12
340	Keilprofil-Stiftschlüssel	03 5
824	Klammer-Grip-Zange	07 11
351	Knarre umsteckbar 1/2", 30 Zähne, DIN 3122 C	04 25
441	Knarre umsteckbar 3/4", 36 Zähne, DIN 3122 C	04 48
1831	Knarre, umsteckbar, funkenfrei	10 5
845	Kombinationszange, DIN ISO 5746	07 2
846	Kombinationszange, DIN ISO 5746	07 2
9845	Kombinationszange, DIN ISO 5746	11 58
1886	Kombinationszange, funkenfrei	10 6
804	Komfort-Abbrechklingen-Messer	08 27
740	Körner, DIN 7250	08 16
1874	Körner, funkenfrei	10 8
3316 MK	Kraft-Einsatz-Garnitur 1/2"	04 62
93316 MK	Kraft-Einsatz-Garnitur 1/2"	11 54
3350	Kraft-Einsatz-Garnitur 1/4" 1/2", DIN 3129	04 63
3310	Kraft-Einsatz 1/2", 6-kant, DIN 3129	04 59
3316	Kraft-Einsatz 1/2", 6-kant, DIN 3129	04 59
1310	Kraft-Einsatz 1/4", 6-kant, DIN 3129	04 56
4310	Kraft-Einsatz 3/4", 6-kant, DIN 3129	04 64
4316	Kraft-Einsatz 3/4", 6-kant, DIN 3129	04 64
2310	Kraft-Einsatz 3/8", 6-kant, DIN 3129	04 57
2318	Kraft-Einsatz 3/8", 6-kant, DIN 3129	04 57
5310	Kraft-Einsatz 1", 6-kant, DIN 3129	04 66
5316	Kraft-Einsatz 1", 6-kant, DIN 3129	04 66
6310	Kraft-Einsatz 1 1/2", 6-kant, DIN 3129	04 70
3312	Kraft-Kardan-Gelenk 1/2"	04 61
4312	Kraft-Kardan-Gelenk 3/4"	04 65
5312	Kraft-Kardan-Gelenk 1"	04 67

Master	Artikel	Seite
3319	Kraft-Schoneinsatz 1/2", 6-kant, DIN 3129	04 62
3319 KK	Kraft-Schoneinsatz-Garnitur 1/2"	04 62
9920 KK	Kraft-Schoneinsatz-Garnitur 1/2", DIN 3129	11 54
547	Kraft-Schraubendreher-Bit-Satz 1/4"	06 17
3314	Kraft-Übergangsteil 1/2" innen, 3/8" außen	04 61
3315	Kraft-Übergangsteil 1/2" innen, 3/4" außen	04 61
1312	Kraft-Übergangsteil 1/4" innen, 3/8" außen	04 56
4314	Kraft-Übergangsteil 3/4" innen, 1/2" außen	04 65
4315	Kraft-Übergangsteil 3/4" außen, 1" außen	04 65
2314	Kraft-Übergangsteil 3/8" innen, 1/4" außen	04 58
2315	Kraft-Übergangsteil 3/8" innen, 1/2" außen	04 58
5314	Kraft-Übergangsteil 1" außen, 3/4" außen	04 67
5315	Kraft-Übergangsteil 1" außen, 1 1/2" außen	04 67
3311	Kraft-Verlängerung 1/2"	04 61
1311	Kraft-Verlängerung 1/4"	04 56
4311	Kraft-Verlängerung 3/4"	04 65
2311	Kraft-Verlängerung 3/8"	04 58
5311	Kraft-Verlängerung 1"	04 67
860	Kraftseitenschneider, DIN ISO 5749	07 3
861	Kraftseitenschneider, DIN ISO 5749	07 3
9860	Kraftseitenschneider, DIN ISO 5749	11 58
730	Kreuzmeißel, DIN 6451	08 14
476	Kreuzschlüssel für LKW	08 2
9476	Kreuzschlüssel für LKW	11 64
475	Kreuzschlüssel für PKW	08 2
9475	Kreuzschlüssel für PKW	11 64
9477	Kreuzschlüssel für PKW	11 64
710	Kunststoff-Hammer	08 13
705	Kupferhammer	08 11
353	Kurbel 1/2", DIN 3123	04 25
L		
3993	L-BOXX® Industrial Line	01 39
832	Langbeck-Grip-Zange	07 12
947	Latthammer	08 11
9947	Latthammer	11 67
782	Löffelschaber, DIN 8351	08 25
M		
346	Maschinen-Adapter 1/2" außen, 1/4" außen, DIN 3126	04 24
548	Maschinen-Adapter 1/4" außen, 1/4" außen, DIN 3126	04 5
9052	Maschinen-Adapter 1/4" außen, 1/4" außen, DIN 3126	11 26
377	Maschinen-Adapter Set 1/4" 3/8" 1/2" außen, 1/4" außen	04 5 04 14 04 24
2346	Maschinen-Adapter 3/8" außen, 1/4" außen, DIN 3126	04 14
2380	Maul-Einsteckwerkzeug	05 5
2381	Maul-Einsteckwerkzeug	05 5
731	Maurermeißel, DIN 7254 A	08 14
725	Metallsägebogen, DIN 6473 A	08 24
727	Metallsägebogen	08 25

Master	Artikel	Seite
9725	Metallsägebogen	11 68
9727	Metallsägebogen	11 68
344 SB	Mini-Adapter Set 1/4" 3/8" 1/2"	04 5
6400	Modul 4 in 1 Doppelring-Ratschenschlüssel	01 8
6420	Modul Adapter	01 11
6140	Modul Doppelmaulschlüssel	01 18
6160	Modul Doppelring-Ratschenschlüssel mit Stopring	01 20
6080	Modul Doppelringschlüssel	01 27
6380	Modul Durchsteck-Doppelring-Ratschenschlüssel-Satz 28 in 1	01 12
6370	Modul Durchsteck-Steckschlüssel-Garnitur 40 in 1	01 12
6290	Modul Hammer, Meißel, Durchtreiber	01 36
6500	Modul Hausmeister-Set Universal	01 35
6410	Modul HOT!FORCE Ringmaulschlüssel	01 19
6340	Modul Innensechskant-Kraft-Einsätze	01 15
6100	Modul Innensechskant-Steckschlüssel-Einsätze	01 9
6200	Modul Innensechskant-Steckschlüssel-Einsätze	01 9
6350	Modul Kraft-Einsätze	01 14
6130	Modul Kraft-Einsätze	01 23
6230	Modul Kraft-Einsätze 3/8" 1/4", lange Ausführung	01 32
6360	Modul Kraft-Schoneinsätze	01 13
6450	Modul leer	01 17
6460	Modul leer	01 17
6470	Modul leer	01 25
6480	Modul leer	01 25
6260	Modul Montagezangen	01 22
6010	Modul Ringmaulschlüssel	01 26
6150	Modul Ringmaulschlüssel	01 27
6490	Modul Ringmaulschlüssel	01 18
6170	Modul Ringmaulschlüssel extra lang	01 26
6190	Modul Ringmaulschlüssel mit Ratsche	01 19
6180	Modul Ringmaulschlüssel mit Stopring	01 20
6030	Modul Schraubendreher	01 24
6240	Modul Schraubendreher	01 34
6440	Modul Schraubendreher	01 15
6390	Modul Sechskant-Stiftschlüssel mit Quergriff	01 28
6120	Modul Steckschlüssel-Einsätze, lange Ausführung	01 23
6020	Modul Steckschlüssel-Garnitur	01 30
6050	Modul Steckschlüssel-Garnitur	01 13
6060	Modul Steckschlüssel-Garnitur	01 16
6430	Modul Steckschlüssel-Garnitur	01 29
6220	Modul Steckschlüssel-Einsätze und Adapter	01 11
6070	Modul Stiftschlüssel-Sätze	01 8
6090	Modul Stiftschlüssel-Sätze	01 21
6270	Modul Stiftschlüssel-Sätze	01 22
6280	Modul Stiftschlüssel-Sätze	01 21
6330	Modul TX Kraft-Schraubendreher-Einsätze	01 14
6250	Modul TX Schraubendreher	01 24
6320	Modul TX Steckschlüssel-Garnitur	01 10
6110	Modul VDE Schraubendreher	01 37
6300	Modul VDE Zangen	01 38
6210	Modul XZN Steckschlüssel-Garnitur	01 10

Master	Artikel	Seite
6040	Modul Zangen	01 33
830	Montagezange, DIN 5254 A	07 5
831	Montagezange, DIN 5254 B	07 5
850	Montagezange, DIN 5256 C	07 5
851	Montagezange, DIN 5256 D	07 5
504	Multigear Steckschlüssel-Einsatz 1/4"	04 2
393	Muttersprenger	08 3
9393	Muttersprenger	11 65
N		
786	Nageleisen, 6-kant	08 25
776	Nietenkopfmacher	08 17
772	Nietenzieher	08 17
719	Nylonschutz	08 10
Ö		
684	Ölfiter Abzieher	08 5
P		
834	Parallel-Klammer-Gripzange	07 12
822	Parallel-Plus-Grip-Zange	07 10
1352	PH Bitbox	06 18
525	PH Schraubendreher, DIN ISO 8764	06 2
574	PH Schraubendreher, DIN ISO 8764	06 4
9535	PH Schraubendreher, DIN ISO 8764	11 55
362	PH Schraubendreher-Einsatz 1/2"	04 20
9362	PH Schraubendreher-Einsatz 1/2"	11 40
503	PH Schraubendreher-Einsatz 1/4"	04 3
9503	PH Schraubendreher-Einsatz 1/4"	11 23
2070	PH Schraubendreher-Einsatz 3/8"	04 11
9070	PH Schraubendreher-Einsatz 3/8"	11 34
1854	PH Schraubendreher, funkenfrei	10 7
538	PH Vergaser-Schraubendreher, DIN ISO 8764	06 14
983	Plattenlegerhammer, DIN 6475	08 12
805	Profi-Sicherheits-Messer	08 28
164	Profi-Werkzeugrucksack	01 40
164 U	Profi-Werkzeugrucksack Universal	01 41
164 V	Profi-Werkzeugrucksack VDE	01 41
163	Profi-Werkzeugtasche	01 42
163 U	Profi-Werkzeugtasche Universal	01 43
163 V	Profi-Werkzeugtasche VDE	01 43
380	Profil-Reifenheber	08 2
1353	PZ Bitbox	06 18
526	PZ Schraubendreher, DIN ISO 8764	06 2
576	PZ Schraubendreher, DIN ISO 8764	06 8
527	PZ Schraubendreher-Einsatz 1/4"	04 3
9527	PZ Schraubendreher-Einsatz 1/4"	11 23
9071	PZ Schraubendreher-Einsatz 3/8"	11 34
576 S	PZ Schraubendreher-Set, DIN ISO 8764	06 8
541	PZ Vergaser-Schraubendreher, DIN ISO 8764	06 14
Q		
348	Quergriff-Schraubendreher für Innen-TORX®-Schrauben	03 5
348 MS	Quergriff-Schraubendreher-Satz für Innen-TORX®-Schrauben	03 8

Master	Artikel	Seite
R		
881	Rabitzzange, DIN ISO 9242	07 6
462	Rad-Steckschlüssel	02 34
9462	Rad-Steckschlüssel	11 20
460	Rad-Steckschlüssel extra lang	02 34
417	Radmutter- und Zündkerzen-Schlüssel	08 8
9130	Ratschenschraubendreher-Garnitur 1/4"	11 58
394	Reißnadel mit Hartmetallspitze	08 9
2317	Ring für Kraft-Einsätze und Verbindungsteile 3/8"	04 57
3318	Ring für Kraft-Einsätze und Verbindungsteile 1/2"	04 61
4318	Ring für Kraft-Einsätze und Verbindungsteile 3/4"	04 65
5318	Ring für Kraft-Einsätze und Verbindungsteile 1"	04 67
2384	Ring-Einsteckwerkzeug	05 5
2385	Ring-Einsteckwerkzeug	05 5
234	Ringmaulschlüssel extra lang	02 10
235	Ringmaulschlüssel mit Ratsche und Stopring	02 21
236	Ringmaulschlüssel mit Ratsche	02 23
237	Ringmaulschlüssel mit Ratsche	02 22
9235	Ringmaulschlüssel mit Ratsche	11 11
234 K	Ringmaulschlüssel-Satz extra lang	02 10
234 RT	Ringmaulschlüssel-Satz extra lang	02 11
235 RT	Ringmaulschlüssel-Satz mit Ratsche	02 21
236 RT	Ringmaulschlüssel-Satz mit Ratsche	02 23
237 KSB	Ringmaulschlüssel-Satz mit Ratsche	02 22
9235 RT	Ringmaulschlüssel-Satz mit Ratsche	11 11
230 K	Ringmaulschlüssel-Satz, Ringseite 15° abgewinkelt, DIN 3113 A	02 6
230 PT	Ringmaulschlüssel-Satz, Ringseite 15° abgewinkelt, DIN 3113 A	02 7
230 RT	Ringmaulschlüssel-Satz, Ringseite 15° abgewinkelt, DIN 3113 A	02 6
230 S	Ringmaulschlüssel-Satz, Ringseite 15° abgewinkelt, DIN 3113 A	02 7
9230 K	Ringmaulschlüssel-Satz, Ringseite 15° abgewinkelt, DIN 3113 A	11 6
9230 RT	Ringmaulschlüssel-Satz, Ringseite 15° abgewinkelt, DIN 3113 A	11 6
9230 S	Ringmaulschlüssel-Satz, Ringseite 15° abgewinkelt, DIN 3113 A	11 5
220 K	Ringmaulschlüssel-Satz, Ringseite gekröpft, DIN 3113 B	02 13
220 RT	Ringmaulschlüssel-Satz, Ringseite gekröpft, DIN 3113 B	02 13
220 S	Ringmaulschlüssel-Satz, Ringseite gekröpft, DIN 3113 B	02 13
230	Ringmaulschlüssel, Ringseite 15° abgewinkelt, DIN 3113 A	02 4
230/1	Ringmaulschlüssel, Ringseite 15° abgewinkelt, DIN 3113 A	02 5
230/1 KSB	Ringmaulschlüssel, Ringseite 15° abgewinkelt, DIN 3113 A	02 5

Master	Artikel	Seite
9230	Ringmaulschlüssel, Ringseite 15° abgewinkelt, DIN 3113 A	11 5
220	Ringmaulschlüssel, Ringseite gekröpft, DIN 3113 B	02 12
825	Rohr-Schweißer-Grip-Zange	07 11
620	Rollgabelschlüssel, DIN 3117 B	02 26
621	Rollgabelschlüssel, DIN 3117 B	02 26
623	Rollgabelschlüssel, DIN 3117 B	02 26
624	Rollgabelschlüssel mit Ratschenfunktion, DIN 3117 B	02 27
920	Rollgabelschlüssel	11 14
1862	Rollgabelschlüssel, funkenfrei	10 4
165	Rolltasche bestückt	01 40
372	Rotationsknarre 1/2", 60 Zähne, DIN 3122 D	04 27
528	Rotationsknarre 1/4", 60 Zähne, DIN 3122 D	04 8
2528	Rotationsknarre 3/8", 60 Zähne, DIN 3122 D	04 16
902	Rundfeile	08 20
1892	Rundfeile, funkenfrei	10 9
905	Rundraspel	08 21
1882	Rundzange, funkenfrei	10 6
706	Rückschlagfreier Schonhammer	08 13
S		
1879	Sägeblatt, funkenfrei	10 8
873	Sanitär-Montageschlüssel	08 8
374	Schlag-Schraubenlöser	08 3
670	Schlagmaulschlüssel, DIN 133	02 32
270	Schlagringschlüssel, DIN 7444	02 31
1827	Schlagringschlüssel, funkenfrei	10 4
733	Schlitzmeißel	08 15
733 HS	Schlitzmeißel mit Sicherheits-Handschutz	08 15
715	Schlosserhammer, DIN 1041	08 10
717	Schlosserhammer, DIN 1041	08 10
9700	Schlosserhammer, DIN 1041	11 67
1870	Schlosserhammer, funkenfrei	10 8
532	Schnellwechsel-Bit-Halter	06 18
549	Schrauben- und Bolzenausdreher-Set für beschädigte Schrauben	08 26
534	Schraubenausdreher-Satz	08 3
542	Schraubendreher mit Magnetbithalter, ähnlich DIN 3125	06 15
543	Schraubendreher-Bit-Satz 1/4"	06 17
361	Schraubendreher-Einsatz 1/2"	04 20
9361	Schraubendreher-Einsatz 1/2"	11 40
502	Schraubendreher-Einsatz 1/4"	04 4
9502	Schraubendreher-Einsatz 1/4"	11 24
2100	Schraubendreher-Einsatz 3/8"	04 11
9076	Schraubendreher-Einsatz 3/8"	11 34
521 S	Schraubendreher-Garnitur, DIN ISO 2380, DIN ISO 8764	06 3
522 S	Schraubendreher-Garnitur, DIN ISO 2380, DIN ISO 8764	06 3
571 S	Schraubendreher-Set, DIN ISO 2380, DIN ISO 8764	06 5
577 S	Schraubendreher-Set, DIN ISO 2380, DIN ISO 8764	06 5
9587 S	Schraubendreher-Set, DIN ISO 2380, DIN ISO 8764	11 55

Master	Artikel	Seite	Master	Artikel	Seite
826	Schweißer-Grip-Zange	07 11	350	Steckschlüssel-Einsatz 1/2", 12-kant, DIN 3124	04 18
480	Sechskant-Steckschlüssel mit Griff, DIN 3125	06 15	9350	Steckschlüssel-Einsatz 1/2", 12-kant, DIN 3124	11 40
481	Sechskant-Steckschlüssel mit Quergriff, DIN 3125	06 16	445	Steckschlüssel-Einsatz 3/4", 12-kant, DIN 3124	04 46
481 MS	Sechskant-Steckschlüssel-Satz mit Quergriff, DIN 3125	06 16	2014	Steckschlüssel-Einsatz 3/8", 12-kant, DIN 3124	04 10
310	Sechskant-Stiftschlüssel, DIN ISO 6911	03 3	2014/1	Steckschlüssel-Einsatz 3/8", 12-kant, DIN 3124	04 10
320	Sechskant-Stiftschlüssel, DIN ISO 2936	03 3	5014	Steckschlüssel-Einsatz 1", 12-kant, DIN 3124	04 52
328	Sechskant-Stiftschlüssel, DIN ISO 2936	03 4	360	Steckschlüssel-Einsatz 1/2", 6-kant, DIN 3124	04 18
330	Sechskant-Stiftschlüssel, DIN ISO 2936	03 4	396	Steckschlüssel-Einsatz 1/2", 6-kant, DIN 3124	04 19
9308	Sechskant-Stiftschlüssel, DIN ISO 2936	11 21	9360	Steckschlüssel-Einsatz 1/2", 6-kant, DIN 3124	11 39
9309	Sechskant-Stiftschlüssel, DIN ISO 2936	11 21	9369	Steckschlüssel-Einsatz 1/2", 6-kant, DIN 3124	11 39
345	Sechskant-Stiftschlüssel mit Quergriff	03 4	500	Steckschlüssel-Einsatz 1/4", 6-kant, DIN 3124	04 2
345 MS	Sechskant-Stiftschlüssel-Set mit Quergriff	03 8	500/1	Steckschlüssel-Einsatz 1/4", 6-kant, DIN 3124	04 2
304 KH	Sechskant-Stiftschlüssel-Satz	03 10	524	Steckschlüssel-Einsatz 1/4", 6-kant, DIN 3124	04 2
306 KH	Sechskant-Stiftschlüssel-Satz	03 10	9500	Steckschlüssel-Einsatz 1/4", 6-kant, DIN 3124	11 23
320 HKH	Sechskant-Stiftschlüssel-Satz	03 7	9590	Steckschlüssel-Einsatz 1/4", 6-kant, DIN 3124	11 23
320 KH	Sechskant-Stiftschlüssel-Satz, DIN ISO 2936	03 10	440	Steckschlüssel-Einsatz 3/4", 6-kant, DIN 3124	04 46
320 PKH	Sechskant-Stiftschlüssel-Satz	03 7	9440	Steckschlüssel-Einsatz 3/4", 6-kant, DIN 3124	11 51
320 PT	Sechskant-Stiftschlüssel-Satz, DIN ISO 2936	03 7	9053	Steckschlüssel-Einsatz 3/8", 6-kant, DIN 3124	11 33
320/1 PT	Sechskant-Stiftschlüssel-Satz, ähnlich DIN ISO 2936	03 7	9901	Steckschlüssel-Einsatz 3/8", 6-kant, DIN 3124	11 33
320 PTR	Sechskant-Stiftschlüssel-Satz, DIN ISO 2936	03 10	3880	Steckschlüssel-Garnitur 1/2"	04 36
328 KH	Sechskant-Stiftschlüssel-Satz, DIN ISO 2936	03 11	3890	Steckschlüssel-Garnitur 1/2"	04 38
330/1 KH	Sechskant-Stiftschlüssel-Satz, ähnlich DIN ISO 2936	03 11	9381	Steckschlüssel-Garnitur 1/2"	11 45
328 KSB	Sechskant-Stiftschlüssel-Satz, DIN ISO 2936	03 12	9382	Steckschlüssel-Garnitur 1/2"	11 44
329 KH	Sechskant-Stiftschlüssel-Satz, DIN ISO 2936	03 11	9515	Steckschlüssel-Garnitur 1/4"	11 31
330 KH	Sechskant-Stiftschlüssel-Satz, DIN ISO 2936	03 11	9516	Steckschlüssel-Garnitur 1/4"	11 29
330 KSB	Sechskant-Stiftschlüssel-Satz, DIN ISO 2936	03 12	9520	Steckschlüssel-Garnitur 1/4"	11 28
9308 PKH	Sechskant-Stiftschlüssel-Satz	11 22	9521	Steckschlüssel-Garnitur 1/4"	11 32
9309 PTR	Sechskant-Stiftschlüssel-Satz, DIN ISO 2936	11 21	9523	Steckschlüssel-Garnitur 1/4"	11 30
9328 KH	Sechskant-Stiftschlüssel-Satz	11 22	5040	Steckschlüssel-Garnitur 1/4"	04 9
1832	Sechskant-Stiftschlüssel, funkenfrei	10 6	448	Steckschlüssel-Garnitur 3/4"	04 49
870	Seitenschneider, DIN ISO 5749	07 2	449	Steckschlüssel-Garnitur 3/4"	04 49
871	Seitenschneider, DIN ISO 5749	07 2	9391	Steckschlüssel-Garnitur 3/4"	11 52
9870	Seitenschneider, DIN ISO 5749	11 58	2490	Steckschlüssel-Garnitur 3/8"	04 17
1884	Seitenschneider, funkenfrei	10 6	9910	Steckschlüssel-Garnitur 3/8"	11 38
302 KH	Sicherheits-Stiftschlüsselsatz	03 2	5900	Steckschlüssel-Garnitur 1"	04 54
367	Sonderprofil Durchsteck-Steckschlüssel-Einsatz	04 30	3920	Steckschlüssel-Garnitur 1/4" 1/2"	04 37
732	Spitzmeißel, DIN 7256	08 14	3930	Steckschlüssel-Garnitur 1/4" 1/2"	04 39
770	Splintentreiber, DIN 6450	08 16	9384	Steckschlüssel-Garnitur 1/4" 1/2"	11 46
770 KH	Splintentreiber-Satz, DIN 6450	08 18	9385	Steckschlüssel-Garnitur 1/4" 1/2"	11 47
770 KK	Splintentreiber-Satz, DIN 6450	08 18	9386	Steckschlüssel-Garnitur 1/4" 1/2"	11 49
770 MK	Splintentreiber-Satz, DIN 6450	08 18	9387	Steckschlüssel-Garnitur 1/4" 1/2"	11 48
415	Stahl-Drahtbürste	11 65	3980	Steckschlüssel-Garnitur 1/4" 1/2" 3/4"	04 50
675	Starter- und Blockschlüssel	02 20	9383	Steckschlüssel-Garnitur 1/4" 3/8" 1/2"	11 50
9675	Starter- und Blockschlüssel	11 9	3990	Steckschlüssel-Garnitur im Tanos-Systainer®	04 44
783	Stechbeitel, DIN 5139	08 23	3992	Steckschlüssel-Garnitur in L-BOXX®	04 45
783 K	Stechbeitel-Satz, DIN 5139	08 23	470	Steckschlüssel, abgewinkelt	02 35
9505	Steckgriff 1/4"	11 26	9470	Steckschlüssel, abgewinkelt	11 20
505	Steckgriff 1/4", DIN 3122 E	04 6	1836	Steckschlüsseleinsatz 1/2", 6-kant, funkenfrei	10 5
350/1	Steckschlüssel-Einsatz 1/2", 12-kant, DIN 3124	04 19	5341	Stehbolzen Ein- und Ausdreher	08 3
			3317	Stift für Kraft-Einsätze und Verbindungsteile 1/2"	04 61
			4317	Stift für Kraft-Einsätze und Verbindungsteile 3/4"	04 65
			2316	Stift für Kraft-Einsätze und Verbindungsteile 3/8"	04 57

Master	Artikel	Seite
5317	Stift für Kraft-Einsätze und Verbindungsteile 1"	04 67
510	Stirnlochschlüssel	02 28
423	Stufen-Drehstift	02 36
9423	Stufen-Drehstift	11 20
3991	Systainer® Classic Line	01 39
T		
798	Tamper TORX®-Schraubendreher	06 12
314 HKH	Tamper TORX®-Stiftschlüssel-Satz	03 6
9314 HKH	Tamper TORX®-Stiftschlüssel-Satz	11 22
966	Taschenmesschieber	08 9
418	Taschenrollbandmaß	08 9
9511	Teleskop-Hebelumschaltknarre 1/4", DIN 3122 D	11 27
576 TD	Thekendisplay PZ Schraubendreher-Garnitur, DIN ISO 8764	06 9
556 TD	Thekendisplay Schraubendreher-Garnituren, DIN ISO 2380, DIN ISO 8764	06 11 09 6
571 TD	Thekendisplay Schraubendreher-Garnituren, DIN ISO 2380, DIN ISO 8764	06 6
577 TD	Thekendisplay Schraubendreher-Garnituren, DIN ISO 2380, DIN ISO 8764	06 7
315	TORX®-Stiftschlüssel	03 5
315 KH	TORX®-Stiftschlüssel-Satz	03 9
315 KSB	TORX®-Stiftschlüssel-Satz	03 9
315 PKH	TORX®-Stiftschlüssel-Satz	03 6
9315 PKH	TORX®-Stiftschlüssel-Satz	11 22
320 KSB	TORX®-Stiftschlüssel-Satz, DIN ISO 2936	03 12
308 KH	TORX®-Stiftschlüssel-Satz, extra lang	03 9
317 KH	TORX®-Stiftschlüssel-Satz mit Kugelkopf	03 9
813	Trapezklinge	08 28
1354	TX Bitbox	06 18
3340	TX Kraft-Einsatz 1/2"	04 60
3340 KK	TX Kraft-Schraubendreher-Einsatz-Garnitur 1/2"	04 63
790	TX Schraubendreher	06 12
357	TX Schraubendreher-Einsatz 1/2"	04 20
9357	TX Schraubendreher-Einsatz 1/2"	11 40
523	TX Schraubendreher-Einsatz 1/4"	04 3
9519	TX Schraubendreher-Einsatz 1/4"	11 24
2320	TX Schraubendreher-Einsatz 3/8"	04 11
9232	TX Schraubendreher-Einsatz 3/8"	11 35
3940	TX Steckschlüssel-Garnitur 1/4" 1/2"	04 34
Ü		
368	Übergangsteil 1/2" innen, 3/4" außen, DIN 3123 A	04 22
369	Übergangsteil 1/2" innen, 3/8" außen, DIN 3123 A	04 22
519	Übergangsteil 1/4" innen, 3/8" außen, DIN 3123 A	04 5
437	Übergangsteil 3/4" innen, 1" außen, DIN 3123 A	04 47
438	Übergangsteil 3/4" innen, 1/2" außen, DIN 3123 A	04 47
2215	Übergangsteil 3/8" innen, 1/2" außen, DIN 3123 A	04 13
9073	Übergangsteil 3/8" innen, 1/2" außen, DIN 3123 A	11 35
1220	Übergangsteil 3/8" innen, 1/4" außen, DIN 3123 A	04 13
9074	Übergangsteil 3/8" innen, 1/4" außen, DIN 3123 A	11 35
5220	Übergangsteil 1" innen, 3/4" außen, DIN 3123 A	04 52

Master	Artikel	Seite
U		
226 KSB	ULTRA PRO-TEC Ringmaulschlüssel-Satz, Ringseite 15° abgewinkelt, DIN 3113 A	02 9
226	ULTRA PRO-TEC Ringmaulschlüssel, Ringseite 15° abgewinkelt, DIN 3113 A	02 9
3359	Umschaltknarre 1/2", 45 Zähne, DIN 3122 D	04 27
5504	Umschaltknarre 1/4", 43 Zähne, DIN 3122 D	04 6
2270	Umschaltknarre 3/8", 41 Zähne, DIN 3122 D	04 14
446	Umschaltknarre 3/8", 60 Zähne, DIN 3122 D	04 48
5260	Umschaltknarre 1", 60 Zähne, DIN 3122 D	04 53
2376	Umschaltknarren-Kopf 1/2" 3/4"	05 4
2375	Umschaltknarren-Kopf 1/4" 3/8" 1/2"	05 4
803	Universal-Abbrechklingen-Messer	08 27
490	Universal-Abzieher	08 6
497	Universal-Abzieher	08 6
498	Universal-Abzieher	08 6
4903	Universal-Abzieher	08 6
8721	Universal-Filterschlüssel	08 4
8722	Universal-Filterschlüssel	08 4
8723	Universal-Filterschlüssel	08 4
828	Universal-Grip-Zange	07 10
9827	Universal-Grip-Zange	11 62
9828	Universal-Grip-Zange	11 62
9829	Universal-Grip-Zange	11 62
385	Universal-Hebeleisen	08 25
872	Universalschlüssel für Ventalnippel 1/2"	04 21 08 8
V		
889	VDE Abisolierzange	09 5
1788	VDE Abisolierzange	09 11
1763	VDE Abmantelmesser	09 10
1791	VDE Drehmomentschlüssel 1/2", DIN 7449	09 8
1769	VDE Einmaulschlüssel, DIN 7446	09 7
1729	VDE Einringschlüssel, DIN 7446	09 7
887	VDE Flachrundzange, DIN ISO 5745	09 4
888	VDE Flachrundzange, DIN ISO 5745	09 5
1789	VDE Flachrundzange, DIN ISO 5745	09 11
1790	VDE Flachrundzange, DIN ISO 5745	09 11
1731	VDE Hebelumschaltknarre 1/2", DIN 7449	09 8
1761	VDE Kabelmesser	09 10
1762	VDE Kabelmesser	09 10
884	VDE Kombinationszange, DIN ISO 5746	09 4
1784	VDE Kombinationszange, DIN ISO 5746	09 10
886	VDE Kraftseitenschneider, DIN ISO 5749	09 4
1786	VDE Kraftseitenschneider, DIN ISO 5749	09 10
1781	VDE Langbeck-Rundzange, DIN ISO 5745	09 11
593	VDE PH Schraubendreher, DIN ISO 8764	06 10 09 6
9593	VDE PH Schraubendreher, DIN ISO 8764	11 56
1771	VDE Sägebogen	09 9
1772	VDE Sägebogen	09 9
9591	VDE Schraubendreher, DIN ISO 2380	11 56

Master	Artikel	Seite
594 S	VDE Schraubendreher-Set, DIN ISO 2380, DIN ISO 8764	06 10 09 6
9594 S	VDE Schraubendreher-Set, DIN ISO 2380, DIN ISO 8764	11 56
1760	VDE Sechskant-Stiftschlüssel mit Quergriff	09 7
885	VDE Seitenschneider, DIN ISO 5749	09 4
1787	VDE Seitenschneider, DIN ISO 5749	09 10
555	VDE Spannungsprüfer	06 14
1748	VDE Steckschlüssel mit Griff, DIN 7445	09 9
1737	VDE Steckschlüssel-Einsatz für Innensechskant-Schrauben 1/2", DIN 7448	09 8
1736	VDE Steckschlüssel-Einsatz 1/2", 6-kant, DIN 7448	09 8
1734	VDE Verlängerung 1/2", DIN 7434	09 9
1780	VDE Wasserpumpenzange, DIN ISO 8976	09 11
591	VDE Werkstatt-Schraubendreher, DIN ISO 2380	06 10 09 6
1700	VDE Werkzeugsatz	09 12
358	Verbindungsvierkant 1/2", DIN 3122	04 22
447	Verbindungsvierkant 3/4", DIN 3122	04 47
2322	Verbindungsvierkant 3/8", DIN 3122	04 13
535	Vergaser-Werkstatt-Schraubendreher, DIN ISO 2380	06 14
356	Verlängerung 1/2", DIN 3123 B	04 23
9355	Verlängerung 1/2", DIN 3123 B	11 42
507	Verlängerung 1/4", DIN 3123 B	04 4
9507	Verlängerung 1/4", DIN 3123 B	11 25
443	Verlängerung 3/4", DIN 3123 B	04 46
9443	Verlängerung 3/4", DIN 3123 B	11 51
2115	Verlängerung 3/8", DIN 3123 B	04 12
9903	Verlängerung 3/8", DIN 3123 B	11 36
5120	Verlängerung 1", DIN 3123 B	04 52
359	Verlängerung mit Kardangelen und T-Griff 1/2"	04 24
370	Verlängerung mit Wobble-Drive 1/2"	04 23
1834	Verlängerung, funkenfrei 1/2"	10 5
9335 HKH	Vielzahnstiftschlüssel-Satz	11 22
901	Vierkantfeile	08 20
897	Vorschneider, DIN ISO 5748	07 6
960	Vorschlaghammer, DIN 1042	08 11
1871	Vorschlaghammer, funkenfrei	10 8
W		
800	Wasserpumpenzange, DIN ISO 8976	07 8
819	Wasserpumpenzange, DIN ISO 8976	07 8
820	Wasserpumpenzange, DIN ISO 8976	07 8
9818	Wasserpumpenzange, DIN ISO 8976	11 61
9819	Wasserpumpenzange, DIN ISO 8976	11 61
1800	Wasserpumpenzange, funkenfrei	10 7
419	Wasserwaage	08 9
9419	Wasserwaage	11 66
520	Werkstatt-Schraubendreher, DIN ISO 2380	06 2
573	Werkstatt-Schraubendreher, DIN ISO 2380	06 4
9530	Werkstatt-Schraubendreher, DIN ISO 2380	11 55
1853	Werkstatt-Schraubendreher, funkenfrei	10 7

Master	Artikel	Seite
140	Werkstattwagen – 5 Schubladen	01 4
143	Werkstattwagen – 5 Schubladen	01 6
142	Werkstattwagen – 7 Schubladen	01 5
145	Werkstattwagen – 7 Schubladen	01 7
103	Werkzeugkasten	01 45
105	Werkzeugkasten	01 45
998	Werkzeugkasten	11 2
108	Werkzeugkasten bestückt	01 44
759 KH	Werkzeugsatz Körner-Durchtreiber	08 18
753 KH	Werkzeugsatz Meißel-Körner-Durchtreiber	08 19
753 KK	Werkzeugsatz Meißel-Körner-Durchtreiber	08 19
753 MK	Werkzeugsatz Meißel-Körner-Durchtreiber	08 19
758 KH	Werkzeugsatz Meißel-Körner-Durchtreiber	08 19
XYZ		
2388	X-4 Drehmomentvervielfältigungsschlüssel	05 7
349	XZN Schraubendreher-Einsatz 1/2"	04 21
9349	XZN Schraubendreher-Einsatz 1/2"	11 41
3900	XZN Steckschlüssel-Garnitur 1/2"	04 35
414	Zimmermannsbleistift	08 9
9414	Zimmermannsbleistift	11 66
416	Zollstock	08 9
9416	Zollstock	11 66
389	Zündkerzen-Einsatz 1/2"	04 21
9389	Zündkerzen-Einsatz 1/2"	11 41
2095	Zündkerzen-Einsatz 3/8"	04 10
9077	Zündkerzen-Einsatz 3/8"	11 33
413	Zündkerzen-Kombinationsschlüssel	02 34
411	Zündkerzen-Schlüssel	08 8
355	Zündkerzen-Werkzeug-Set 1/2"	04 24

Master	Item	Page
297	4 in 1 Double-Box Gear Wrench	02 25
297 KSB	4 in 1 Double-Box Gear Wrench Set	02 25
475	4-Way Wheel Wrench for cars	08 2
9475	4-Way Wheel Wrench for cars	11 64
9477	4-Way Wheel Wrench for cars	11 64
476	4-Way Wheel Wrench for trucks	08 2
9476	4-Way Wheel Wrench for trucks	11 64
A		
368	Adaptor 1/2" female, 3/4" male, DIN 3123 A	04 22
369	Adaptor 1/2" female, 3/8" male, DIN 3123 A	04 22
519	Adaptor 1/4" female, 3/8" male, DIN 3123 A	04 5
438	Adaptor 3/4" female, 1/2" male, DIN 3123 A	04 47
437	Adaptor 3/4" female, 1" male, DIN 3123 A	04 47
2215	Adaptor 3/8" female, 1/2" male, DIN 3123 A	04 13
9073	Adaptor 3/8" female, 1/2" male, DIN 3123 A	11 35
1220	Adaptor 3/8" female, 1/4" male, DIN 3123 A	04 13
9074	Adaptor 3/8" female, 1/4" male, DIN 3123 A	11 35
5220	Adaptor 1" female, 3/4" male, DIN 3123 A	04 52
620	Adjustable Wrench, DIN 3117 B	02 26
621	Adjustable Wrench, DIN 3117 B	02 26
623	Adjustable Wrench, DIN 3117 B	02 26
624	Adjustable Wrench with Ratchet-Function, DIN 3117 B	02 27
920	Adjustable Wrench	11 14
1862	Adjustable Wrench, spark free	10 4
510	Adjustable Pin Wrench	02 28
2373	Automatic Torque Wrench 1/2"	05 3
2374	Automatic Torque Wrench 1/4"	05 2
2371	Automatic Torque Wrench 3/8"	05 2
9239	Automatic Torque Wrench 3/8"	11 53
2395	Automatic Torque Wrench	05 4
2389	Automatic Torque Wrench for Insert Tools	05 3
9373	Automatic Torque Wrench Set 1/2"	11 53
421	Automotive Light Tester	08 7
B		
3351	Bit Adaptor 1/2", DIN 3126	04 23
9051	Bit Adaptor 1/2", DIN 3126	11 43
1351	Bit Adaptor 1/4", DIN 3126	04 4
2522	Bit Adaptor 3/8", DIN 3126	04 12
8883	Bolt Cutters	07 7
C		
896	Cable Cutters	07 6
414	Carpenter's Pencil	08 9
9414	Carpenter's Pencil	11 66
880	Carpenter's Pincers, DIN ISO 9243	07 6
1881	Carpenter's Pincers, spark free	10 7
740	Centre Punch, DIN 7250	08 16
1874	Centre Punch, spark free	10 8
833	Chain Grip Pliers	07 12
753 KH	Chisel and Punch Set	08 19
753 KK	Chisel and Punch Set	08 19
753 MK	Chisel and Punch Set	08 19
758 KH	Chisel and Punch Set	08 19

Master	Item	Page
830	Circlip Pliers, DIN 5254 A	07 5
831	Circlip Pliers, DIN 5254 B	07 5
850	Circlip Pliers, DIN 5256 C	07 5
851	Circlip Pliers, DIN 5256 D	07 5
824	Clamp Grip Pliers	07 11
235	Combination Gear Wrench with Stopping	02 20
236	Combination Gear Wrench	02 23
237	Combination Gear Wrench	02 22
9235	Combination Gear Wrench	11 11
9236	Combination Gear Wrench	11 13
235 RT	Combination Gear Wrench Set	02 20
236 RT	Combination Gear Wrench Set	02 23
237 KSB	Combination Gear Wrench Set	02 22
9235 RT	Combination Gear Wrench Set	11 11
9236 RT	Combination Gear Wrench Set	11 13
845	Combination Pliers, DIN ISO 5746	07 2
846	Combination Pliers, DIN ISO 5746	07 2
9845	Combination Pliers, DIN ISO 5746	11 58
1886	Combination Pliers, spark free	10 6
234	Combination Spanner extra long	02 10
234 K	Combination Spanner Set extra long	02 10
234 RT	Combination Spanner Set extra long	02 11
230 K	Combination Spanner Set, Ring 15° Offset, DIN 3113 A	02 6
230 PT	Combination Spanner Set, Ring 15° Offset, DIN 3113 A	02 7
230 RT	Combination Spanner Set, Ring 15° Offset, DIN 3113 A	02 6
230 S	Combination Spanner Set, Ring 15° Offset, DIN 3113 A	02 7
9230 K	Combination Spanner Set, Ring 15° Offset, DIN 3113 A	11 6
9230 RT	Combination Spanner Set, Ring 15° Offset, DIN 3113 A	11 6
9230 S	Combination Spanner Set, Ring 15° Offset, DIN 3113 A	11 5
230/1KSB	Combination Spanner Set, Ring 15° Offset, DIN 3113 A	02 5
220 RT	Combination Spanner Set, Ring Offset, DIN 3113 B	02 12
220 K	Combination Spanner Set, Ring Offset, DIN 3113 B	02 13
220 S	Combination Spanner Set, Ring Offset, DIN 3113 B	02 13
230	Combination Spanner, Ring 15° Offset, DIN 3113 A	02 4
230/1	Combination Spanner, Ring 15° Offset, DIN 3113 A	02 5
9230	Combination Spanner, Ring 15° Offset, DIN 3113 A	11 5
220	Combination Spanner, Ring Offset, DIN 3113 B	02 12
413	Combination Spark Plug Wrench	02 34
580	Combination Swivel Head Wrench	02 20
9580	Combination Swivel Head Wrench	11 14
804	Comfort Snap Off Blade Knife	08 27
705	Copper Hammer	08 11
801	Crimping Pliers for end sleeves	07 7
730	Crosscut Chisel, DIN 6451	08 14
D		
280	Deep Ring Spanner, straight, DIN 3111	02 31
870	Diagonal Cutters, DIN ISO 5749	07 2
871	Diagonal Cutters, DIN ISO 5749	07 2
9870	Diagonal Cutters, DIN ISO 5749	11 58
1884	Diagonal Cutters, spark free	10 6
804 TD	Display Comfort Snap Off Blade Knife	08 27

Master	Item	Page
549 TD	Display Screw and Bolt Remover for damaged screws	08 26
556 TD	Display Screwdriver Sets, DIN ISO 2380, DIN ISO 8764	06 11 09 6
571 TD	Display Screwdriver Sets, DIN ISO 2380, DIN ISO 8764	06 6
577 TD	Display Screwdriver Sets, DIN ISO 2380, DIN ISO 8764	06 7
576 TD	Display PZ Screwdriver Sets, DIN ISO 8764	06 9
3980 D	Display Socket Sets 1/4" 1/2" 3/4"	04 51
803 TD	Display Universal Snap Off Blade Knife	08 27
9295	Double-Box Gear Wrench	11 13
9295 RT	Double-Box Gear Wrench Set	11 13
9215	Double Ended Ring Spanner for Outside TORX® Screws	11 8
215	Double Ended Ring Spanner for TX	02 20
290 K	Double Ended Ring Spanner Set, Offset, DIN 838	02 17
290 RT	Double Ended Ring Spanner Set, Offset, DIN 838	02 17
290 S	Double Ended Ring Spanner Set, Offset, DIN 838	02 16
9290 RT	Double Ended Ring Spanner Set, Offset	11 8
210 K	Double Ended Ring Spanner Set, straight, DIN 837 B	02 18
290	Double Ended Ring Spanner, Offset, DIN 838	02 16
9290	Double Ended Ring Spanner, Offset	11 7
1829	Double Ended Ring Spanner, Offset, spark free	10 4
210	Double Ended Ring Spanner, straight, DIN 837 B	02 18
9210	Double Ended Ring Spanner, straight, DIN 837 B	11 9
9290 S	Double Ended Spanner Set, Offset	11 7
455	Double Ended Tubular Box Wrench	02 35
9455	Double Ended Tubular Box Wrench	11 19
450	Double Ended Tubular Box Wrench, DIN 896 B	02 33
9450	Double Ended Tubular Box Wrench, DIN 896 B	11 19
450 K	Double Ended Tubular Box Wrench Set, DIN 896 B	02 33
462	Double Ended Wheel Nut Wrench	02 34
9462	Double Ended Wheel Nut Wrench	11 20
690	Double Open Ended Spanner, DIN 3110	02 2
9650	Double Open Ended Spanner, DIN 895	11 18
9659	Double Open Ended Spanner, DIN 895	11 17
9690	Double Open Ended Spanner, DIN 3110	11 3
690 K	Double Open Ended Spanner Set, DIN 3110	02 3
690 RT	Double Open Ended Spanner Set, DIN 3110	02 3
690 S	Double Open Ended Spanner Set, DIN 3110	02 2
9690 K	Double Open Ended Spanner Set, DIN 3110	11 4
9690 RT	Double Open Ended Spanner Set, DIN 3110	11 4
9690 S	Double Open Ended Spanner Set, DIN 3110	11 3
1869	Double Open Ended Spanner, Spark Free	10 4
298	Double Ring Ratchet Spanner for Go-Through Sockets	04 28
295	Double-Box Gear Wrench with Stopping	02 24
E		
347	E-TX Screwdriver Socket 1/2"	04 21
9365	E-TX Screwdriver Socket 1/2"	11 41
9522	E-TX Screwdriver Socket 1/4"	11 24
2016	E-TX Screwdriver Socket 3/8"	04 10
9078	E-TX Screwdriver Socket 3/8"	11 34

Master	Item	Page
734	Electrician's Chisel	08 15
610	Electrician's Double Open Ended Spanner	02 19
520	Engineers Screwdriver, DIN ISO 2380	06 2
573	Engineers Screwdriver, DIN ISO 2380	06 4
9530	Engineers Screwdriver, DIN ISO 2380	11 55
1853	Engineers Screwdriver, spark free	10 7
9511	Extendable Reversible Ratchet 1/4", lever type, DIN 3122 D	11 27
356	Extension Bar 1/2", DIN 3123 B	04 23
9355	Extension Bar 1/2", DIN 3123 B	11 42
507	Extension Bar 1/4", DIN 3123 B	04 4
9507	Extension Bar 1/4", DIN 3123 B	11 25
443	Extension Bar 3/4", DIN 3123 B	04 46
9443	Extension Bar 3/4", DIN 3123 B	11 51
2115	Extension Bar 3/8", DIN 3123 B	04 12
9903	Extension Bar 3/8", DIN 3123 B	11 36
5120	Extension Bar 1", DIN 3123 B	04 52
359	Extension Bar with Universal Joint and T-Holder 1/2"	04 24
370	Extension Bar with Wobble-Drive 1/2"	04 23
1834	Extension Bar 1/2", spark free 1/2"	10 5
9529	Extension Bar 1/4", flexible	11 25
835	Extension/Replacement Chain	07 12
F		
391	Feeler Gauge	08 7
907 K	File-Set	08 21
783	Firmer Chisel, DIN 5139	08 23
783 K	Firmer Chisel Set, DIN 5139	08 23
784	Firmer Gouge, DIN 5142	08 23
240	Flare Nut Spanner, DIN 3118 A	02 19
9240	Flare Nut Spanner, DIN 3118 A	11 10
9240 K	Flare Nut Spanner Set, DIN 3118 A	11 10
750	Flat Chisel, DIN 6453	08 14
904	Flat File	08 21
1890	Flat File, spark free	10 9
1883	Flat Nose Pliers, spark free	10 6
781	Flat Scraper, DIN 8350 A	08 24
529	Flexible Extension 1/4"	04 4
365	Flexible Handle 1/2", DIN 3122 F	04 25
572	Flexible Handle 1/4", DIN 3122 F	04 6
2321	Flexible Handle 3/8", DIN 3122 F	04 14
409	Flexible Magnetic Lifter	08 7
416	Folding Rule	08 9
9416	Folding Rule	11 66
897	Front Cutters, DIN ISO 5748	07 6
G		
376	Go-Through Adaptor	04 28
518	Go-Through Bit Adaptor	04 28
375	Go-Through Double Ring Socket	04 28
375/1	Go-Through Double Ring Socket	04 28
3970	Go-Through Double-Box Gear Wrench Set "28 in 1" 1/4" 3/8" 1/2"	04 29
371	Go-Through Ratchet, Lever Type, 72 teeth	04 43

Master	Item	Page
373	Go-Through Ratchet, 72 teeth	04 30
366	Go-Through Socket	04 42
379	Go-Through Socket Adaptor	04 30
382	Go-Through Socket Adaptor	04 43
383	Go-Through Socket Adaptor	04 42
378	Go-Through Socket Extension	04 30
381	Go-Through Socket Extension	04 42
3960	Go-Through Socket Set „40 in 1“	04 31
3992	Go-Through Socket Set in L-Boxx®	04 45
3990	Go-Through Socket Set in Tanos-Systainer®	04 44
303 KH	Grip Hexagon Key Wrench Set	03 2
827	Grip Pliers	07 10
H		
725	Hacksaw, DIN 6473 A	08 24
727	Hacksaw	08 25
9725	Hacksaw	11 68
9727	Hacksaw	11 68
1878	Hacksaw Frame, spark free	10 8
675	Half Moon Ring Spanner	02 20
9675	Half Moon Ring Spanner	11 9
903	Half-Round File	08 20
1891	Half-Round File, spark free	10 9
906	Half-Round Rasp	08 21
860	Heavy Duty Diagonal Cutters, DIN ISO 5749	07 3
861	Heavy Duty Diagonal Cutters, DIN ISO 5749	07 3
9860	Heavy Duty Diagonal Cutters, DIN ISO 5749	11 58
250	Heavy Duty Ring Spanner	02 30
5363	Hexagon Impact Socket 1"	04 66
310	Hexagon Key Wrench, DIN ISO 6911	03 3
320	Hexagon Key Wrench, DIN ISO 2936	03 3
328	Hexagon Key Wrench, DIN ISO 2936	03 4
330	Hexagon Key Wrench, DIN ISO 2936	03 4
9308	Hexagon Key Wrench, DIN ISO 2936	11 21
9309	Hexagon Key Wrench, DIN ISO 2936	11 21
304 KH	Hexagon Key Wrench Set	03 10
306 KH	Hexagon Key Wrench Set	03 10
320 HKH	Hexagon Key Wrench Set	03 7
320 KH	Hexagon Key Wrench Set, DIN ISO 2936	03 10
320 PKH	Hexagon Key Wrench Set	03 7
320 PT	Hexagon Key Wrench Set, DIN ISO 2936	03 7
320/1 PT	Hexagon Key Wrench Set, similar to DIN ISO 2936	03 7
320 PTR	Hexagon Key Wrench Set, DIN ISO 2936	03 10
328 KH	Hexagon Key Wrench Set, DIN ISO 2936	03 11
330/1 KH	Hexagon Key Wrench Set, similar to DIN ISO 2936	03 11
328 KSB	Hexagon Key Wrench Set, DIN ISO 2936	03 12
329 KH	Hexagon Key Wrench Set, DIN ISO 2936	03 11
330 KH	Hexagon Key Wrench Set, DIN ISO 2936	03 11
330 KSB	Hexagon Key Wrench Set, DIN ISO 2936	03 12
9308 PKH	Hexagon Key Wrench Set	11 22
9309 PTR	Hexagon Key Wrench Set, DIN ISO 2936	11 21
9328 KH	Hexagon Key Wrench Set	11 22
1832	Hexagon Key Wrench, spark free	10 6

Master	Item	Page
480	Hexagon Nut Driver with Handle, DIN 3125	06 15
481	Hexagon Nut Driver with T-Handle, DIN 3125	06 16
481 MS	Hexagon Nut Driver Set with T-Handle, DIN 3125	06 16
501	Hexagon Screwdriver Socket 1/4"	04 3
2051	Hexagon Screwdriver Socket 3/8", DIN 7422	04 11
515	Hinged Hook Wrench	02 28
516	Hinged Hook Wrench	02 28
814	Hook Blade	08 28
680	Hook Wrench	02 29
681	Hook Wrench	02 29
224	HOT!FORCE Combination Spanner	02 14
224 K	HOT!FORCE Combination Spanner Set	02 15
224 RT	HOT!FORCE Combination Spanner Set	02 15
726	HSS saw blade, DIN 6494 A	08 24
I		
829	Ideal Grip Pliers	07 10
3315	Impact Adaptor 1/2" female, 3/4" male	04 61
3314	Impact Adaptor 1/2" female, 3/8" male	04 61
1312	Impact Adaptor 1/4" female, 3/8" male	04 56
4314	Impact Adaptor 3/4" female, 1/2" male	04 65
4315	Impact Adaptor 3/4" female, 1" male	04 65
2315	Impact Adaptor 3/8" female, 1/2" male	04 58
2314	Impact Adaptor 3/8" female, 1/4" male	04 58
5314	Impact Adaptor 1" female, 3/4" male	04 67
5315	Impact Adaptor 1" female, 1 1/2" male	04 67
374	Impact Driver Set	08 3
3311	Impact Extension Bar 1/2"	04 61
1311	Impact Extension Bar 1/4"	04 56
4311	Impact Extension Bar 3/4"	04 65
2311	Impact Extension Bar 3/8"	04 58
5311	Impact Extension Bar 1"	04 67
547	Impact Screwdriver Bit Set 1/4"	06 17
3310	Impact Socket 1/2", 6-point, DIN 3129	04 59
3316	Impact Socket 1/2", 6-point, DIN 3129	04 59
6310	Impact Socket 1/2", 6-point, DIN 3129	04 70
1310	Impact Socket 1/4", 6-point, DIN 3129	04 56
4310	Impact Socket 3/4", 6-point, DIN 3129	04 64
4316	Impact Socket 3/4", 6-point, DIN 3129	04 64
2310	Impact Socket 3/8", 6-point, DIN 3129	04 57
2318	Impact Socket 3/8", 6-point, DIN 3129	04 57
5310	Impact Socket 1", 6-point, DIN 3129	04 66
5316	Impact Socket 1", 6-point, DIN 3129	04 66
3316 MK	Impact Socket Set 1/2"	04 62
93316 MK	Impact Socket Set 1/2"	11 54
3350	Impact Socket Set 1/4" 1/2", DIN 3129	04 63
3312	Impact Universal Joint 1/2"	04 61
4312	Impact Universal Joint 3/4"	04 65
5312	Impact Universal Joint 1"	04 67
4364	Inside Hexagon Impact Socket 3/4"	04 64
3363	Inside Hexagon Impact Socket 1/2", 6-point	04 60
3363 KK	Inside Hexagon Impact Socket Set 1/2"	04 63
363	Inside Hexagon Screwdriver Socket 1/2", DIN 7422	04 20

Master	Item	Page
9363	Inside Hexagon Screwdriver Socket 1/2", DIN 7422	11 40
9501	Inside Hexagon Screwdriver Socket 1/4", DIN 7422	11 24
9902	Inside Hexagon Screwdriver Socket 3/8", DIN 7422	11 35
3950	Inside Hexagon Socket Set 1/2"	04 32
3910	Inside Hexagon Socket Set 1/4" 1/2"	04 33
873	Installation Wrench	08 8
J		
3511	Joint Extendable Reversible Ratchet 1/2", 72 teeth, DIN 3122 D	04 26
511	Joint Extendable Reversible Ratchet 1/4", 72 teeth, DIN 3122 D	04 7
2511	Joint Extendable Reversible Ratchet 3/8", 72 Teeth, DIN 3122 D	04 15
735	Jointing Chisel	08 15
L		
3993	L-BOXX® Industrial Line	01 39
3317	Locking Pin for Impact Sockets and Connecting Parts 1/2"	04 61
2316	Locking Pin for Impact Sockets and Connecting Parts 3/8"	04 57
5317	Locking Pin for Impact Sockets and Connecting Parts 1"	04 67
5318	Locking Ring for Impact Sockets and Connecting Parts 1"	04 67
3318	Locking Ring for Impact Sockets and Connecting Parts 1/2"	04 61
4318	Locking Ring for Impact Sockets and Connecting Parts 3/4"	04 65
2317	Locking Ring for Impact Sockets and Connecting Parts 3/8"	04 57
832	Long Nose Grip Pliers	07 12
M		
346	Machinery Adaptor 1/2" male, 1/4" male, DIN 3126	04 24
548	Machinery Adaptor 1/4" male, 1/4" male, DIN 3126	04 5
9052	Machinery Adaptor 1/4" male, 1/4" male, DIN 3126	11 26
2346	Machinery Adaptor 3/8" male, 1/4" male, DIN 3126	04 14
377	Machinery Adaptor Set 1/4" 3/8" 1/2" male, 1/4" male	04 5 04 14 04 24
715	Machinist's Hammer, DIN 1041	08 10
717	Machinist's Hammer, DIN 1041	08 10
9700	Machinist's Hammer, DIN 1041	11 67
1870	Machinist's Hammer, spark free	10 8
731	Mason's Chisel, DIN 7254 A	08 14
9984	Mason's Hammer	11 67
344 SB	Mini Adaptor Set 1/4" 3/8" 1/2"	04 5
935	Mining Sledge Hammer, DIN 6475	08 12
937	Mining Sledge Hammer, DIN 6475	08 12
9935	Mining Sledge Hammer, DIN 6475	11 67
6010	Modul Combination Spanner	01 26
6400	Module 4 in 1 Double-Box Gear Wrench	01 8
6420	Module Adaptor Set	01 11

Master	Item	Page
6260	Module Circlip Pliers	01 22
6190	Module Combination Gear Wrench	01 19
6180	Module Combination Gear Wrenches with Stopping	01 20
6150	Module Combination Spanner	01 27
6490	Module Combination Spanner	01 18
6170	Module Combination Spanner extra long	01 26
6080	Module Double Ended Ring Spanner	01 27
6160	Module Double-Box Gear Wrench with stopping	01 20
6140	Module Double Open Ended Spanners	01 18
6450	Module empty	01 17
6460	Module empty	01 17
6470	Module empty	01 25
6480	Module empty	01 25
6380	Module Go-Through Double-Box Wrench Set 28 in 1	01 12
6370	Module Go-Through Socket Set 40 in 1	01 12
6290	Module Hammer, Chisels and Punches	01 36
6070	Module Hexagon Key Wrench Sets	01 8
6090	Module Hexagon Key Wrench Sets	01 21
6270	Module Hexagon Key Wrench Sets	01 22
6280	Module Hexagon Key Wrench Sets	01 21
6410	Module HOT!FORCE Combination Spanner Set	01 19
6350	Module Impact Sockets	01 14
6130	Module Impact Sockets	01 23
6230	Module Impact Sockets 3/8" 1/2", long	01 32
6340	Module Inside Hexagon Impact Sockets	01 15
6100	Module Inside Hexagon Sockets	01 9
6200	Module Inside Hexagon Sockets	01 9
6500	Module Janitor Set Universal	01 35
6040	Module Pliers	01 33
6360	Module Protective Impact Sockets	01 13
6030	Module Screwdriver	01 24
6240	Module Screwdriver	01 34
6440	Module Screwdriver	01 15
6060	Module Screwdriver Bit Set	01 16
6220	Module Screwdriver Sockets and Adaptors	01 11
6020	Module Socket Set	01 30
6050	Module Socket Set	01 13
6430	Module Socket Set	01 29
6120	Module Sockets, long	01 23
6390	Module T-Handle Hexagon Key Wrench	01 28
6330	Module TX Impact Sockets	01 14
6250	Module TX Screwdrivers	01 24
6320	Module TX Socket Set	01 10
6300	Module VDE Pliers	01 38
6110	Module VDE Screwdriver	01 37
6210	Module XZN Socket Set	01 10
9335 HKH	Multi-Spline Key Wrench Set	11 22
504	Multigear Socket 1/4"	04 2
N		
786	Nail Puller, 6-point	08 25
393	Nut Splitter	08 3

Master	Item	Page
9393	Nut Splitter	11 65
719	Nylon Head	08 10
O		
684	Oil Service Remover	08 5
2380	Open Ended Insert Tool	05 5
2381	Open Ended Insert Tool	05 5
P		
770	Parallel Pin Punch, DIN 6450	08 16
770 KH	Parallel Pin Punch Set, DIN 6450	08 18
770 KK	Parallel Pin Punch Set, DIN 6450	08 18
770 MK	Parallel Pin Punch Set, DIN 6450	08 18
822	Parallel Plus Grip Pliers	07 10
834	Parallel-Clamp Crip Pliers	07 12
983	Paver's Hammer, DIN 6475	08 12
1352	PH Bitbox	06 18
525	PH Screwdriver, DIN ISO 8764	06 2
574	PH Screwdriver, DIN ISO 8764	06 4
9535	PH Screwdriver, DIN ISO 8764	11 55
362	PH Screwdriver Socke 1/2"	04 20
9362	PH Screwdriver Socke 1/2"	11 40
503	PH Screwdriver Socket 1/4"	04 3
9503	PH Screwdriver Socket 1/4"	11 23
2070	PH Screwdriver Socket 3/8"	04 11
9070	PH Screwdriver Socket 3/8"	11 34
1854	PH Screwdriver, spark free	10 7
538	PH Stubby Screwdriver, DIN ISO 8764	06 14
810	Pipe Wrench, DIN 5234	07 9
811	Pipe Wrench, DIN 5234	07 9
812	Pipe Wrench, DIN 5234	07 9
1888	Pipe Wrench, spark free	10 7
718	Plaster's hatched Hammer	08 11
710	Plastic Faced Hammer	08 13
418	Pocket Measuring Tape	08 9
732	Pointed Chisel, DIN 7256	08 14
163	Professional Tool Bag	01 42
163 U	Professional Tool Bag Universal	01 43
163 V	Professional Tool Bag VDE	01 43
164	Professional Tool Backpack	01 40
164 U	Professional Tool Backpack Universal	01 41
164 V	Professional Tool Backpack VDE	01 41
805	Profi Safety Knife	08 28
754	Protective Hand Guard	08 15
3319 KK	Protective Impact Socket Set 1/2"	04 62
9920 KK	Protective Impact Socket Set 1/2", DIN 3129	11 54
3319	Protective Impact Socket 1/2", 6-point, DIN 3129	04 62
759 KH	Punch Set	08 18
351	Push-Through Ratchet 1/2", 30 teeth, DIN 3122 C	04 25
1831	Push-Through Ratchet 1/2", spark free	10 5
441	Push-Through Ratchet 3/4", 36 teeth, DIN 3122 C	04 48
1353	PZ Bitbox	06 18
526	PZ Screwdriver, DIN ISO 8764	06 2
576	PZ Screwdriver, DIN ISO 8764	06 8

Master	Item	Page
576 S	PZ Screwdriver Set, DIN ISO 8764	06 8
527	PZ Screwdriver Socket 1/4"	04 3
9527	PZ Screwdriver Socket 1/4"	11 23
9071	PZ Screwdriver Socket 3/8"	11 34
541	PZ Stubby Screwdriver, DIN ISO 8764	06 14
Q		
532	Quick Release Bit Holder	06 18
R		
706	Recoil Free Soft Faced Hammer	08 13
2376	Reversible Ratchet Head 1/2" 3/4"	05 4
2375	Reversible Ratchet Head 1/4" 3/8" 1/2"	05 4
3359	Reversible Ratchet 1/2", 45 teeth, DIN 3122 D	04 27
5504	Reversible Ratchet 1/4", 43 teeth, DIN 3122 D	04 6
444	Reversible Ratchet 3/4", 24 teeth, DIN 3122 D	04 48
446	Reversible Ratchet 3/4", 60 teeth, DIN 3122 D	11 48
2270	Reversible Ratchet 3/8", 41 teeth, DIN 3122 D	04 14
9366	Reversible Ratchet 1/2", lever type, 72 teeth, DIN 3122 D	11 43
3066	Reversible Ratchet 1/2", lever type, 72 teeth, curved shaft, DIN 3122 D	04 26
3067	Reversible Ratchet 1/2", lever type, 72 teeth, straight shaft, DIN 3122 D	04 26
9512	Reversible Ratchet 1/4", lever type, 72 teeth, DIN 3122 D	11 27
5012	Reversible Ratchet 1/4", lever type, 72 teeth, curved shaft, DIN 3122 D	04 6
5013	Reversible Ratchet 1/4", lever type, 72 teeth, straight shaft, DIN 3122 D	04 7
9439	Reversible Ratchet 3/4", lever type, 24 teeth, DIN 3122 D	11 51
9907	Reversible Ratchet 3/8", lever type, 72 teeth, DIN 3122 D	11 36
2356	Reversible Ratchet 3/8", lever type, 72 teeth, curved shaft, DIN 3122 D	04 15
2357	Reversible Ratchet 3/8", lever type, 72 teeth, straight shaft, DIN 3122 D	04 15
5260	Reversible Ratchet 1", 60 teeth, DIN 3122 D	04 53
372	Reversible Ratchet 1/2", turnable, 60 teeth, DIN 3122 D	04 27
528	Reversible Ratchet 1/4", turnable, 60 teeth, DIN 3122 D	04 8
2528	Reversible Ratchet 3/8", turnable, 60 teeth, DIN 3122 D	04 16
2384	Ring Insert Tool	05 5
2385	Ring Insert Tool	05 5
776	Rivet Header	08 17
772	Rivet Set	08 17
165	Roll-Pouch, equipped	01 40
947	Roofing Hammer	08 11
9947	Roofing Hammer	11 67
902	Round File	08 20
1892	Round File, spark free	10 9

Master	Item	Page
1882	Round Nose Pliers, spark free	10 6
905	Round Rasp	08 21
936	Rubber Attachment for Mining Sledge Hammer	08 12
950	Rubber Hammer, DIN 5128 A	08 13
9950	Rubber Hammer, DIN 5128 A	11 68
S		
302 KH	Safety Hexagon Key Wrench Set	03 2
1879	Saw Blade, spark free	10 8
549	Screw and Bolt Remover for damaged screws	08 26
534	Screw Extractor Set	08 3
543	Screwdriver Bit Set 1/4"	06 17
9130	Screwdriver Bit Set 1/4"	11 58
521 S	Screwdriver Set, DIN ISO 2380, DIN ISO 8764	06 3
522 S	Screwdriver Set, DIN ISO 2380, DIN ISO 8764	06 3
571 S	Screwdriver Set, DIN ISO 2380, DIN ISO 8764	06 5
577 S	Screwdriver Set, DIN ISO 2380, DIN ISO 8764	06 5
9587 S	Screwdriver Set, DIN ISO 2380, DIN ISO 8764	11 55
361	Screwdriver Socket 1/2"	04 20
9361	Screwdriver Socket 1/2"	11 40
502	Screwdriver Socket 1/4"	04 4
9502	Screwdriver Socket 1/4"	11 25
2100	Screwdriver Socket 3/8"	04 11
9076	Screwdriver Socket 3/8"	11 34
542	Screwdriver with magnetic Bit Holder, similar to DIN 3125	06 15
394	Scriber Tungsten Carbide Tipped	08 9
760	Section Punch, DIN 6458	08 16
1876	Section Punch, spark free	10 8
460	Single Ended Wheel Nut Wrench extra long	02 34
9640	Single Open Ended Spanner, DIN 894	11 16
9649	Single Open Ended Spanner, DIN 894	11 15
960	Sledge Hammer, DIN 1042	08 11
1871	Sledge Hammer, spark free	10 8
354	Sliding T-Handle 1/2", DIN 3122 A	04 23
9354	Sliding T-Handle 1/2", DIN 3122 A	11 42
506	Sliding T-Handle 1/4", DIN 3122 A	04 4
9506	Sliding T-Handle 1/4", DIN 3122 A	11 25
442	Sliding T-Handle 3/4", DIN 3122 A	04 46
9442	Sliding T-Handle 3/4", DIN 3122 A	11 51
2165	Sliding T-Handle 3/8", DIN 3122 A	04 12
9075	Sliding T-Handle 3/8", DIN 3122 A	11 36
5160	Sliding T-Handle 1", DIN 3122 A	04 53
733	Slitting Chisel	08 15
733 HS	Slitting Chisel with Protective Hand Guard	08 15
670	Slugging Open Jaw Wrench, DIN 133	02 32
270	Slugging Ring Wrench, DIN 7444	02 31
1827	Slugging Ring Wrench, spark free	10 4
815	Snap Off Blade	08 27
890	Snipe Nose Pliers, DIN ISO 5745	07 3
891	Snipe Nose Pliers, DIN ISO 5745	07 4
892	Snipe Nose Pliers, DIN ISO 5745	07 3
893	Snipe Nose Pliers, DIN ISO 5745	07 4

Master	Item	Page
9890	Snipe Nose Pliers, DIN ISO 5745	11 60
9891	Snipe Nose Pliers, DIN ISO 5745	11 60
1885	Snipe Nose Pliers, spark free	10 6
3880	Socket Set 1/2"	04 36
3890	Socket Set 1/2"	04 38
9381	Socket Set 1/2"	11 45
9382	Socket Set 1/2"	11 44
5040	Socket Set 1/4"	04 9
9515	Socket Set 1/4"	11 31
9516	Socket Set 1/4"	11 29
9520	Socket Set 1/4"	11 28
9521	Socket Set 1/4"	11 32
9523	Socket Set 1/4"	11 30
448	Socket Set 3/4"	04 49
449	Socket Set 3/4"	04 49
9391	Socket Set 3/4"	11 52
2490	Socket Set 3/8"	04 17
9910	Socket Set 3/8"	11 38
5900	Socket Set 1"	04 54
3920	Socket Set 1/4" 1/2"	04 37
3930	Socket Set 1/4" 1/2"	04 39
9384	Socket Set 1/4" 1/2"	11 46
9385	Socket Set 1/4" 1/2"	11 47
9386	Socket Set 1/4" 1/2"	11 49
9387	Socket Set 1/4" 1/2"	11 48
3980	Socket Set 1/4" 1/2" 3/4"	04 50
9383	Socket Set 1/4" 3/8" 1/2"	11 50
470	Socket Wrench, angled	02 35
9470	Socket Wrench, angled	11 20
350/1	Socket 1/2", 12-point, DIN 3124	04 18
350	Socket 1/2", 12-point, DIN 3124	04 18
9350	Socket 1/2", 12-point, DIN 3124	11 39
445	Socket 3/4", 12-point, DIN 3124	04 46
2014/1	Socket 3/8", 12-point, DIN 3124	04 10
2014	Socket 3/8", 12-point, DIN 3124	04 10
5014	Socket 1", 12-point, DIN 3124	04 52
360	Socket 1/2", 6-point, DIN 3124	04 18
396	Socket 1/2", 6-point, DIN 3124	04 19
9360	Socket 1/2", 6-point, DIN 3124	11 39
9369	Socket 1/2", 6-point, DIN 3124	11 39
500	Socket 1/4", 6-point, DIN 3124	04 2
500/1	Socket 1/4", 6-point, DIN 3124	04 2
524	Socket 1/4", 6-point, DIN 3124	04 2
9500	Socket 1/4", 6-point, DIN 3124	11 23
9590	Socket 1/4", 6-point, DIN 3124	11 23
440	Socket 3/4", 6-point, DIN 3124	04 46
9440	Socket 3/4", 6-point, DIN 3124	11 51
9053	Socket 3/8", 6-point, DIN 3124	11 33
9901	Socket 3/8", 6-point, DIN 3124	11 33
1836	Socket 1/2", 6-point, spark free	10 5
720	Spare Head	08 13
389	Spark Plug Socket 1/2"	04 21

Master	Item	Page
9389	Spark Plug Socket 1/2"	11 41
2095	Spark Plug Socket 3/8"	04 10
9077	Spark Plug Socket 3/8"	11 33
411	Spark Plug Socket Wrench	08 8
417	Spark Plug Socket Wrench	08 8
355	Spark Plug-Tool-Set 1/2"	04 24
367	Special Profile Go-Through Socket	04 30
353	Speeder Handle 1/2", DIN 3123	04 25
9505	Spinner Handle 1/4"	11 26
505	Spinner Handle 1/4", DIN 3122 E	04 6
340	Spline Key Wrench	03 5
782	Spoon Scraper, DIN 8351	08 25
358	Square Coupler 1/2", DIN 3122	04 22
447	Square Coupler 3/4", DIN 3122	04 47
2322	Square Coupler 3/8", DIN 3122	04 13
901	Square File	08 20
3068	Staging Ratchet, 32 Teeth, reversible	04 25
415	Steel Wire Brush	11 64
423	Stepped Tommy Bar	02 36
9423	Stepped Tommy Bar	11 20
866	Strap Wrench	08 5
8661	Strap Wrench	08 4
9866	Strap Wrench	11 65
535	Stubby Engineers Screwdriver, DIN ISO 2380	06 14
5341	Stud Insertor and Extractor	08 3
3991	Systainer® Classic Line	01 39
T		
345	T-Handle Hexagon Key Wrench	03 4
345 MS	T-Handle Hexagon Key Wrench Set	03 8
348	T-Handle Screwdriver for inside TORX® screws	03 5
348 MS	T-Handle Screwdriver Set for inside TORX® screws	03 8
314 HKH	Tamper TORX® Key Wrench Set	03 6
9314 HKH	Tamper TORX® Key Wrench Set	11 22
798	Tamper TORX® Screwdriver	06 12
420	Tommy Bar	02 36
430	Tommy Bar, DIN 900 A	02 36
103	Tool Box	01 45
105	Tool Box	01 45
998	Tool Box	11 2
108	Tool Box, equipped	01 44
140	Tool Trolley – 5 Compartments	01 4
142	Tool Trolley – 7 Compartments	01 5
143	Tool Trolley – 5 Compartments	01 6
145	Tool Trolley – 7 Compartments	01 7
315	TORX®-Key Wrench	03 5
315 KH	TORX®-Key Wrench Set	03 9
315 KSB	TORX® Key Wrench Set	03 9
315 PKH	TORX® Key Wrench Set	03 6
9315 PKH	TORX® Key Wrench Set	11 22
320 KSB	TORX® Key Wrench Set, DIN ISO 2936	03 12
308 KH	TORX® Key Wrench Set, extra long	03 9
317 KH	TORX® Key Wrench Set with Ballpoint	03 9

Master	Item	Page
881	Tower Pincers, DIN ISO 9242	07 6
900	Triangular File	08 20
780	Triangular Hollow Shape Scraper, DIN 8350 C	08 24
813	Trimming Knife Blade	08 28
260	Tubular Handle	02 30
9510	Turnable Reversible Ratchet 1/4", lever type, DIN 3122 D	11 27
785	Turning Tool, DIN 5144	08 23
1354	TX Bitbox	06 18
3340	TX Impact Socket 1/2"	04 60
3340 KK	TX Impact Socket Set 1/2"	04 63
790	TX Screwdriver	06 12
790 S	TX Screwdriver Set	06 13
357	TX Screwdriver Socket 1/2"	04 20
9357	TX Screwdriver Socket 1/2"	11 40
523	TX Screwdriver Socket 1/4"	04 3
9519	TX Screwdriver Socket 1/4"	11 24
2320	TX Screwdriver Socket 3/8"	04 11
9232	TX Screwdriver Socket 3/8"	11 35
3940	TX Socket Set 1/4" 1/2"	04 34
380	Tyre Lever	08 2
U		
226	ULTRA PRO-TEC Combination Spanner, Ring 15° Offset, DIN 3113 A	02 9
226 KSB	ULTRA PRO-TEC Combination Spanner Set, Ring 15° Offset, DIN 3113 A	02 9
8721	Universal Filter Wrench	08 4
8722	Universal Filter Wrench	08 4
8723	Universal Filter Wrench	08 4
828	Universal Grip Pliers	07 10
9827	Universal Grip Pliers	11 62
9828	Universal Grip Pliers	11 62
9829	Universal Grip Pliers	11 62
352	Universal Joint 1/2", DIN 3123 C	04 22
9352	Universal Joint 1/2", DIN 3123 C	11 42
509	Universal Joint 1/4", DIN 3123 C	04 4
9509	Universal Joint 1/4", DIN 3123 C	11 26
2110	Universal Joint 3/8", DIN 3123 C	04 12
9906	Universal Joint 3/8", DIN 3123 C	11 36
385	Universal Prybar	08 25
490	Universal Puller	08 6
497	Universal Puller	08 6
498	Universal Puller	08 6
4903	Universal Puller	08 6
803	Universal Snap Off Blade Knife	08 27
872	Universal Wrench for valves 1/2"	04 21
V		
1761	VDE Cable Knife	09 10
1762	VDE Cable Knife	09 10
884	VDE Combination Pliers, DIN ISO 5746	09 4
1784	VDE Combination Pliers, DIN ISO 5746	09 10
885	VDE Diagonal Cutters, DIN ISO 5749	09 4

Master	Item	Page
1787	VDE Diagonal Cutters, DIN ISO 5749	09 10
1763	VDE Dismantling Knife	09 10
591	VDE Engineers Screwdriver, DIN ISO 2380	06 10 09 6
1734	VDE Extension Bar 1/2", DIN 7434	09 9
1771	VDE Hacksaw	09 9
1772	VDE Hacksaw	09 9
886	VDE Heavy Duty Diagonal Cutters, DIN ISO 5749	09 4
1786	VDE Heavy Duty Diagonal Cutters, DIN ISO 5749	09 10
1781	VDE Long Round Nose Pliers, DIN ISO 5745	09 11
1748	VDE Nutdriver with handle, DIN 7445	09 9
593	VDE PH Screwdriver, DIN ISO 8764	06 10 09 6
9593	VDE PH Screwdriver, DIN ISO 8764	11 56
1731	VDE Reversible Ratchet 1/2", DIN 7449	09 8
9591	VDE Screwdriver, DIN ISO 2380	11 56
594 S	VDE Screwdriver Set DIN ISO 2380, DIN ISO 8764	06 10 09 6
9594 S	VDE Screwdriver Set DIN ISO 2380, DIN ISO 8764	11 56
1729	VDE Single Ended Ring Spanner, DIN 7446	09 7
1769	VDE Single Open Ended Spanner, DIN 7446	09 7
887	VDE Snipe Nose Pliers, DIN ISO 5745	09 4
888	VDE Snipe Nose Pliers, DIN ISO 5745	09 5
1789	VDE Snipe Nose Pliers, DIN ISO 5745	09 11
1790	VDE Snipe Nose Pliers, DIN ISO 5745	09 11
1737	VDE Socket for inside hexagon screws 1/2", DIN 7448	09 8
1736	VDE Socket 1/2", 6-point, DIN 7448	09 8
1760	VDE T-Handle Hexagon Key Wrench	09 7
1700	VDE Tool Set	09 12
1791	VDE Torque Wrench 1/2", DIN 7449	09 8
555	VDE Voltage Tester	06 14
1780	VDE Water Pump Pliers, DIN ISO 8976	09 11
889	VDE Wire Stripper	09 5
1788	VDE Wire Stripping Pliers	09 11
966	Vernier Callipers	08 9
W		
771	Wad Punch, DIN 7200 A	08 22
9771	Wad Punch, DIN 7200 A	11 63
771 HK	Wad Punch Set, DIN 7200 A	08 22
419	Water Level	08 9
9419	Water Level	11 66
800	Water Pump Pliers, DIN ISO 8976	07 8
819	Water Pump Pliers, DIN ISO 8976	07 8
820	Water Pump Pliers, DIN ISO 8976	07 8
9818	Water Pump Pliers, DIN ISO 8976	11 61
9819	Water Pump Pliers, DIN ISO 8976	11 61
1800	Water Pump Pliers, spark free	10 7
826	Welder's Grip Pliers	07 11
825	Welder's Grip Pliers for Tubes	07 11
823	Wide Jaw Grip Pliers	07 11
1893	Wire Brush, spark free	10 9























Master	Item	Page
882	Wire Stripping Pliers, DIN ISO 5744	07 4
883	Wire Stripping Pliers	07 4
9882	Wire Stripping Pliers	11 60
X		
2388	X-4 Multiplier Wrench	05 7
349	XZN Screwdriver Socket 1/2"	04 21
9349	XZN Screwdriver Socket 1/2"	11 41
3900	XZN Socket Set	04 35

Master-Nr. item no.	Seite page	Master-Nr. item no.	Seite page	Master-Nr. item no.	Seite page	Master-Nr. item no.	Seite page	Master-Nr. item no.	Seite page	Master-Nr. item no.	Seite page
100		310	03 3	379	04 30	515	02 28	715	08 10	827	07 10
103	01 45	314 HKH	03 6	380	08 2	516	02 28	717	08 10	828	07 10
105	01 45	315	03 5	381	04 42	518	04 28	718	08 11	829	07 10
108	01 44	315 KH	03 9	382	04 43	519	04 5	719	08 10	830	07 5
140	01 4	315 KSB	03 9	383	04 42	520	06 2	720	08 13	831	07 5
142	01 5	315 PKH	03 6	385	08 25	521 S	06 3	725	08 24	832	07 12
143	01 6	317 KH	03 9	389	04 21	522 S	06 3	726	08 24	833	07 12
145	01 7	320	03 3	391	08 7	523	04 3	727	08 25	834	07 12
163	01 42	320 HKH	03 7	393	08 3	524	04 2	730	08 14	835	07 12
163 U	01 43	320 KH	03 10	394	08 9	525	06 2	731	08 14	845	07 2
163 V	01 43	320 KSB	03 12	396	04 19	526	06 2	732	08 14	846	07 2
164	01 40	320 PKH	03 7	400		527	04 3	733	08 15	850	07 5
164 U	01 41	320 PT	03 7	409	08 7	528	04 8	733 HS	08 15	851	07 5
164 V	01 41	320 PTR	03 10	411	08 8	529	04 4	734	08 15	860	07 3
165	01 40	320/1 PT	03 7	413	02 34	532	06 18	735	08 15	861	07 3
200		328	03 4	414	08 9	534	08 3	740	08 16	866	08 5
210	02 18	328 KH	03 11	415	11 65	535	06 14	750	08 14	870	07 2
210 K	02 18	328 KSB	03 12	416	08 9	538	06 14	753 KH	08 19	871	07 2
215	02 20	329 KH	03 11	417	08 8	541	06 14	753 KK	08 19	872	04 21
220	02 12	330	03 4	418	08 9	542	06 15	753 MK	08 19	872	08 8
220 K	02 13	330 KH	03 11	419	08 9	543	06 17	754	08 15	873	08 8
220 RT	02 12	330 KSB	03 12	420	02 36	547	06 17	758 KH	08 19	880	07 6
220 S	02 13	330/1 KH	03 11	421	08 7	548	04 5	759 KH	08 18	881	07 6
224	02 14	340	03 5	423	02 36	549	08 26	760	08 16	882	07 4
224 K	02 15	344 SB	04 5	430	02 36	549 TD	08 26	770	08 16	883	07 4
224 RT	02 15	345	03 4	437	04 47	555	06 14	770 KH	08 18	884	09 4
226	02 9	345 MS	03 8	438	04 47	556 TD	06 11	770 KK	08 18	885	09 4
226 KSB	02 9	346	04 24	440	04 46		09 6	770 MK	08 18	886	09 4
230	02 4	347	04 21	441	04 48	571 S	06 5	771	08 22	887	09 4
230 K	02 6	348	03 5	442	04 46	571 TD	06 6	771 HK	08 22	888	09 5
230 PT	02 7	348 MS	03 8	443	04 47	572	04 6	772	08 17	889	09 5
230 RT	02 6	349	04 21	444	04 48	573	06 4	776	08 17	890	07 3
230 S	02 7	350/1	04 18	445	04 46	574	06 4	780	08 24	891	07 4
230/1	02 5	350	04 18	446	04 48	576	06 8	781	08 24	892	07 3
230/1 KSB	02 5	351	04 25	447	04 47	576 S	06 8	782	08 25	893	07 4
234	02 10	352	04 22	448	04 49	576 TD	06 9	783	08 23	896	07 6
234 K	02 10	353	04 25	449	04 49	577 S	06 5	783 K	08 23	897	07 6
234 RT	02 11	354	04 23	450	02 33	577 TD	06 7	784	08 23	900	
235	02 20	355	04 24	450 K	02 33	580	02 20	785	08 23	900	08 20
235 RT	02 20	356	04 23	455	02 35	591	06 10	786	08 25	901	08 20
236	02 23	357	04 20	460	02 34		09 6	790	06 12	902	08 20
236 RT	02 23	358	04 22	462	02 34	593	06 10	790 S	06 13	903	08 20
237	02 22	359	04 24	470	02 35		09 6	798	06 12	904	08 21
237 KSB	02 22	360	04 18	475	08 2	594 S	06 10	800		905	08 21
240	02 19	361	04 20	476	08 2		09 6	800	07 8	906	08 21
250	02 30	362	04 20	480	06 15	600		801	07 7	907 K	08 21
260	02 30	363	04 20	481	06 16	610	02 19	803	08 27	920	11 14
270	02 31	365	04 25	481 MS	06 16	620	02 26	803 TD	08 27	935	08 12
280	02 31	366	04 42	490	08 6	621	02 26	804	08 27	936	08 12
290	02 16	367	04 30	497	08 6	623	02 26	804 TD	08 27	937	08 12
290 K	02 17	368	04 22	498	08 6	624	02 27	805	08 28	947	08 11
290 RT	02 17	369	04 22	500		670	02 32	810	07 9	950	08 13
290 S	02 16	370	04 23	500	04 2	675	02 20	811	07 9	960	08 11
295	02 24	371	04 43	500/1	04 2	680	02 29	812	07 9	966	08 9
295 RT	02 24	372	04 27	501	04 3	681	02 29	813	08 28	983	08 12
297	02 25	373	04 30	502	04 4	684	08 5	814	08 28	998	11 2
297 KSB	02 25	374	08 3	503	04 3	690	02 2	815	08 27	1000	
298	04 28	375	04 28	504	04 2	690 K	02 3	819	07 8	1220	04 13
300		375/1	04 28	505	04 6	690 RT	02 3	820	07 8	1310	04 56
302 KH	03 2	376	04 28	506	04 4	690 S	02 2	822	07 10	1311	04 56
303 KH	03 2	377	04 5	507	04 4	700		823	07 11	1312	04 56
304 KH	03 10		04 14	509	04 4	705	08 11	824	07 11	1351	04 4
306 KH	03 10		04 24	510	02 28	706	08 13	825	07 11	1352	06 18
308 KH	03 9	378	04 30	511	04 7	710	08 13	826	07 11	1353	06 18

Master-Nr. item no.	Seite page	Master-Nr. item no.	Seite page	Master-Nr. item no.	Seite page	Master-Nr. item no.	Seite page	Master-Nr. item no.	Seite page	Master-Nr. item no.	Seite page
1354	06 18	2270	04 14	3980 D	04 51	6270	01 22	9308	11 21	9522	11 24
1700	09 12	2310	04 57	3990	04 44	6280	01 21	9308 PKH	11 22	9523	11 30
1729	09 7	2311	04 58	3991	01 39	6290	01 36	9308 PT	11 21	9527	11 23
1731	09 8	2314	04 58	3992	04 45	6300	01 38	9309	11 21	9529	11 25
1734	09 9	2315	04 58	3993	01 39	6310	04 70	9309 PTR	11 21	9530	11 55
1736	09 8	2316	04 57	4000		6320	01 10	9314 HKH	11 22	9535	11 55
1737	09 8	2317	04 57	4310	04 64	6330	01 14	9315 PKH	11 22	9580	11 14
1748	09 9	2318	04 57	4311	04 65	6340	01 15	9328 KH	11 22	9587 S	11 55
1760	09 7	2320	04 11	4312	04 65	6350	01 14	9335 HKH	11 22	9590	11 23
1761	09 10	2321	04 14	4314	04 65	6360	01 13	9349	11 41	9591	11 56
1762	09 10	2322	04 13	4315	04 65	6370	01 12	9352	11 42	9593	11 56
1763	09 10	2346	04 14	4316	04 64	6380	01 12	9354	11 42	9594 S	11 56
1769	09 7	2356	04 15	4317	04 65	6390	01 28	9355	11 42	9640	11 16
1771	09 9	2357	04 15	4318	04 65	6400	01 8	9357	11 40	9649	11 15
1772	09 9	2371	05 2	4364	04 64	6410	01 19	9350	11 39	9650	11 18
1780	09 11	2373	05 3	4903	08 6	6420	01 11	9360	11 39	9659	11 17
1781	09 11	2374	05 2	5000		6430	01 29	9361	11 40	9675	11 9
1784	09 10	2375	05 4	5012	04 6	6440	01 15	9362	11 40	9690	11 3
1786	09 10	2376	05 4	5013	04 7	6450	01 17	9363	11 40	9690 K	11 4
1787	09 10	2380	05 5	5014	04 52	6460	01 17	9365	11 41	9690 RT	11 4
1788	09 11	2381	05 5	5040	04 9	6470	01 25	9366	11 43	9690 S	11 3
1789	09 11	2384	05 5	5120	04 52	6480	01 25	9369	11 39	9700	11 67
1790	09 11	2385	05 5	5160	04 53	6490	01 18	9373	11 53	9725	11 68
1791	09 8	2388	05 7	5220	04 52	6500	01 35	9381	11 45	9727	11 68
1800	10 7	2389	05 3	5260	04 53	6510	01 31	9382	11 44	9771	11 63
1827	10 4	2395	05 4	5310	04 66	8000		9383	11 51	9818	11 61
1829	10 4	2490	04 17	5311	04 67	8661	08 4	9384	11 46	9819	11 61
1831	10 5	2511	04 15	5312	04 67	8721	08 4	9385	11 47	9827	11 62
1832	10 6	2522	04 12	5314	04 67	8722	08 4	9386	11 49	9828	11 62
1834	10 5	2528	04 16	5315	04 67	8723	08 4	9387	11 48	9829	11 62
1836	10 5	3000		5316	04 66	8883	07 7	9389	11 41	9845	11 58
1853	10 7	3066	04 26	5317	04 67	9000		9391	11 52	9860	11 58
1854	10 7	3067	04 26	5318	04 67	9051	11 42	9393	11 65	9866	11 65
1862	10 4	3068	04 25	5341	08 3	9052	11 20	9414	11 66	9870	11 58
1869	10 4	3310	04 59	5363	04 66	9053	11 33	9416	11 66	9882	11 60
1870	10 8	3311	04 61	5504	04 6	9070	11 34	9419	11 66	9890	11 60
1871	10 8	3312	04 61	5900	04 54	9071	11 34	9423	11 20	9891	11 60
1874	10 8	3314	04 61	6000		9073	11 35	9439	11 51	9901	11 33
1876	10 8	3315	04 61	6010	01 26	9074	11 35	9440	11 51	9902	11 35
1878	10 8	3316	04 62	6020	01 30	9075	11 36	9442	11 51	9903	11 36
1879	10 8	3316 MK	04 59	6030	01 24	9076	11 34	9443	11 51	9906	11 36
1881	10 7	3317	04 61	6040	01 33	9077	11 33	9450	11 19	9907	11 36
1882	10 6	3318	04 61	6050	01 13	9078	11 34	9455	11 19	9910	11 38
1883	10 6	3319	04 62	6060	01 16	9130	11 58	9462	11 20	9920 KK	11 54
1884	10 6	3319 KK	04 62	6070	01 8	9210	11 9	9470	11 20	9935	11 67
1885	10 6	3340	04 60	6080	01 27	9215	11 8	9475	11 64	9947	11 67
1886	10 6	3340 KK	04 63	6090	01 21	9230	11 5	9476	11 64	9950	11 68
1888	10 7	3350	04 63	6100	01 9	9230 K	11 6	9477	11 64	9984	11 67
1890	10 9	3351	04 23	6110	01 37	9230 RT	11 6	9500	11 23	90000	
1891	10 9	3359	04 27	6120	01 23	9230 S	11 5	9501	11 24	93316 MK	11 54
1892	10 9	3363	04 60	6130	01 23	9232	11 35	9502	11 24		
1893	10 9	3363 KK	04 63	6140	01 18	9235	11 11	9503	11 23		
2000		3511	04 26	6150	01 27	9235 RT	11 11	9506	11 25		
2014	04 10	3880	04 36	6160	01 20	9236	11 12	9505	11 26		
2014/1	04 10	3890	04 38	6170	01 26	9236 RT	11 12	9507	11 25		
2016	04 10	3900	04 35	6180	01 20	9239	11 3	9509	11 26		
2051	04 11	3910	04 33	6190	01 19	9240	11 10	9510	11 27		
2070	04 11	3920	04 37	6200	01 9	9240 K	11 10	9511	11 27		
2095	04 10	3930	04 39	6210	01 10	9290	11 7	9512	11 27		
2100	04 11	3940	04 34	6220	01 11	9290 K	11 8	9515	11 31		
2110	04 12	3950	04 32	6230	01 32	9290 RT	11 8	9516	11 29		
2115	04 12	3960	04 31	6240	01 34	9290 S	11 7	9519	11 24		
2165	04 12	3970	04 29	6250	01 24	9295	11 13	9520	11 28		
2215	04 13	3980	04 50	6260	01 22	9295 RT	11 13	9521	11 32		

ZEICHENERKLÄRUNG

EXPLANATION OF ICONS

290	Artikel-Masternummer item number		Gewicht in Gramm weight grams
Art.-No.	Bestellnummer reference no.		Inhalt Verpackungseinheit packing unit
mm	Gesamtlänge total length		Schlüsselweite Zoll A/F spanner width inch A/F
	Schlüsselweite mm spanner width		Durchmesser in mm diameter in mm
	für Außensechskant-Muttern for outside hexagon nuts		Innen-Sechskant in mm inside hexagon in mm
	für Innensechskant-Schrauben for inside hexagon screws		Innen-XZN in mm inside XZN in mm
	für Innen-XZN-Schrauben for inside XZN-screws		für PZ-Kreuzschlitzschrauben for PZ recessed head screws
	für PH-Kreuzschlitzschrauben for PH recessed head screws		für Innen-RIBE-Schrauben for inside RIBE screws
	für Schlitzschrauben for slotted screws		für Außen-Torx-Schrauben for outside Torx screws
	für Innen-Torx-Schrauben for inside Torx screws		Abmessung Stirnloch dimension key hole
	Drehstift tommy bar		Zapfendurchmesser pin diameter
	Sicherungsring in mm circlip in mm		Innen-Vierkant inside square drive
	4-kant-Antrieb square drive		



1/4" 6,3 mm Vierkant-Antrieb
1/4" 6,3 mm square drive



3/8" 10 mm Vierkant-Antrieb
3/8" 10 mm square drive



1/2" 12,5 mm Vierkant-Antrieb
1/2" 12,5 mm square drive



3/4" 20 mm Vierkant-Antrieb
3/4" 20 mm square drive



1" 25 mm Vierkant-Antrieb
1" 25 mm square drive



Einsteckteil 9x12 mm
interchangeable 9x12 mm



Einsteckteil 14x18 mm
interchangeable 14x18 mm



Spanntiefe
clamping depth



Spannweite
clamping width



Anzahl Zähne
number of teeth



Gewicht Hammerkopf
Weight hammer head



Achtkantschaft in mm
octagonal shaft



für Gewinde ...
for threads ...



Schneidenbreite
tip width



Klingenlänge
blade length



Klingenbreite
blade width



Schneidenstärke
tip thickness



Schaftbreite
width of shaft



Schenkellänge
arm length



Klingenlänge
blade length



T-Griff Heftmaße
T-handle length

Die in unseren Produktkatalogen sowie sonstigen Print- und Onlinewerbemitteln gezeigten Waren bzw. das dort verwandte Bildmaterial kann von der ausgelieferten Ware abweichen. Weiterhin ist in den Abbildungen auch keine Beschaffenheitsangabe zu sehen.

All goods shown in our product catalogues or other print and online media respectively the shown images can differ from the goods supplied. Further the images do not represent the final condition of the goods.

**WIR HABEN THE
ZERTIFIKAT.**





WE ARE CERTIFIED!

- **Alle unsere Fertigungsstätten und Kooperationsstandorte setzen auf ein ISO-zertifiziertes Qualitäts- und Umweltmanagement.**
- **Ob hier oder woanders, unsere Fertigungsstätten sind nach internationalen sozialen und ethischen Standards zertifiziert.**
- **Jedes Werkzeug wird nach allen spezifisch zugehörigen DIN- und ISO-Normen gefertigt.**
- **Normal kann jeder. Über die jeweilige DIN- und ISO-Norm hinaus, versichern wir mindestens 25% mehr Drehmoment für all unsere Werkzeuge.**
- **Unsere Garantie: Auch die Korrosionsbeständigkeit unserer Oberflächen liegt mindestens 25% über der Norm.**
- **Wir nehmen es genauer als genau. Unsere Schlüsselweiten-Toleranzen setzen wir enger als DIN es vorgibt.**
- **Auf den Punkt. Die Härtewerte unserer Werkzeuge sind genauer als die jeweilige Norm es vorschreibt.**
- **Im Fall der Fälle können Sie von uns spezifische Prüfzertifikate der Versuchs- und Prüfanstalt Remscheid für unsere Qualitäts-Handwerkzeuge erhalten.**
- **Alle Drehmomentschlüssel sind kalibriert und zertifiziert. Sollte dies nicht mehr der Fall sein, dann kalibrieren wir gern nach.**
- All our production facilities and cooperation sites rely on ISO-certified quality management and environmental management.
- Wherever they're located, our production facilities are certified according to international social and ethical standards.
- Each tool is manufactured in accordance with all specific relevant DIN and ISO standards.
- We're not content with the bare minimum. Above and beyond the relevant DIN and ISO standards, we guarantee at least 25% additional torque for all our tools.
- Our guarantee: Our surfaces also provide corrosion resistance at least 25% above the standard.
- We take precision seriously. Our spanner size tolerances are narrower than the DIN requirements.
- On the dot. The hardness values of our tools are more precise than required by the relevant standards.
- If necessary, we can provide you with specific testing certificates from the Remscheid research centre and testing institute for our quality hand tools.
- All our torque spanners are calibrated and certified. If this is no longer the case, we are happy to recalibrate them.

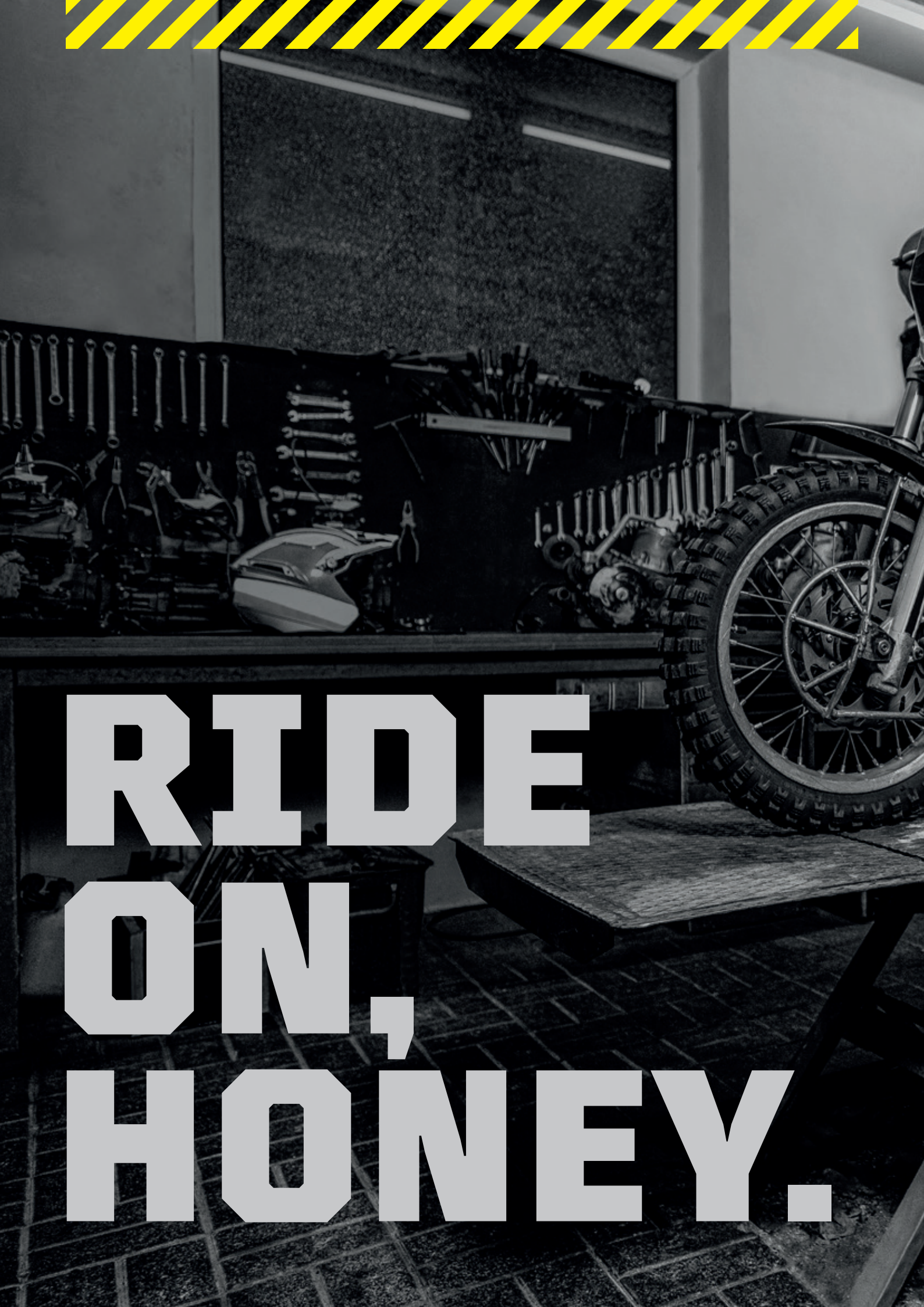

**RIDE
ON,
HONEY.**



Keine in der Werkstatt verboten!

WGB

THE WERKZEUG WAGEN





WERKZEUGAUFBEWAHRUNG
TOOL STORAGE

01

MOFLEX

DAS MODULARE TRANSPORT- UND AUF- BEWAHRUNGSSYSTEM FÜR HANDWERKZEUGE

Mit MOFLEX bist du für jeden Einsatz gut vorbereitet. Du musst nichts suchen, denn du hast alles geplant, geordnet und griffbereit. Das macht dich schneller, flexibler – und es schont dein Werkzeug. Du stellst dir deine Profi-Tools einfach genauso zusammen, wie es für dich am besten passt. Egal für welches Gewerk, egal ob für die Werkstatt oder für die Baustelle. Wenn du willst, jeden Tag anders.

- Hochwertiges Werkzeug immer griffbereit
- Sicherer Transport und schonende Aufbewahrung
- Maximale Flexibilität durch die drei miteinander kombinierbaren Modulgrößen
- Mit verstärkten Bodenplatten und Griffmulden – für die sichere Einzelentnahme
- Hohe Beständigkeit gegen Säure und Öle
- Passend für:
 - WGB-Profi-Werkstattwagen
 - TANOS-systainer® kombinierbar mit über 80 Marken, wie: Makita, Festtool, Brillux, Wagner, Storch, ABB, u. v. m.
 - L-BOXX® kombinierbar mit über 70 Marken, wie: Bosch, Spax, Fischer, Kukko, Viessmann, Heller, u. v. m.
 - die meisten Werkbänke und Werkstattwagen

THE MODULAR TRANSPORT AND STORAGE SYSTEM FOR HAND TOOLS

With MOFLEX you are good prepared for every deployment. You do not have to search for something, because there is everything planned, organized and ready to hand. This makes you faster and more flexible – and spares your tools. You just constellate your own professional tool set as may best please you. No matter which field, no matter if it's for your garage or roadworks. If you want every day different.

- High quality hand tools allways ready to hand
- Safe transport and gently storage
- Maximal flexibility because you can choose between 3 combinable module sizes
- With reinforced floor panels and handholds – for the safe removal
- High resistance aganist acid an oils
- Suitable for :
 - WGB Tool Trolley
 - TANOS-systainer® combinable with over 80 brands, like Makita, Festtool, Brillux, Wagner, Storch, ABB ...
 - L-BOXX® combinable with over 70 brands, like Bosch, Spax, Fischer, Kukko, Viessmann, Heller ...
 - the most workbenches and tool trolleys

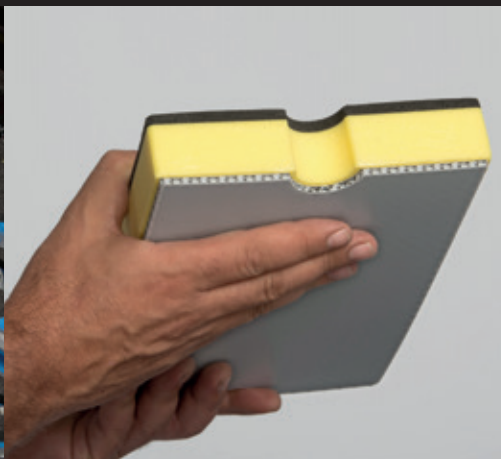



6400



6340



6090



6010



6430



6240



6070



6440



6280



6100



6060

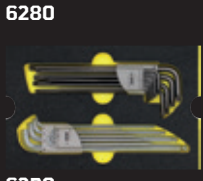

6270



6200



6450

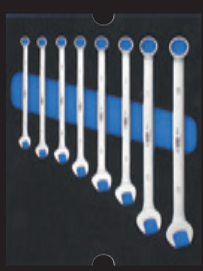

6170



6020



6500



6320



6460

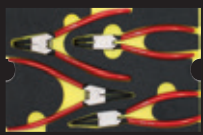

6260



6210



6140

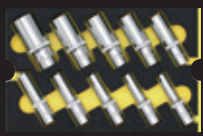

6120



6150



6510



6290



6420



6490



6130



6080



6230

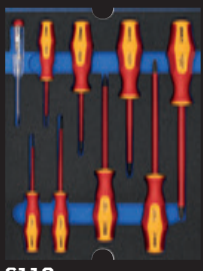

6110



6220



6470



6030

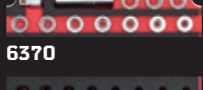

6370



6410



6050



6390

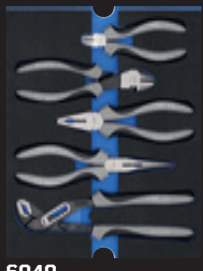

6040



6300



6380



6190



6250



6360

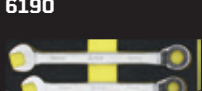

6180

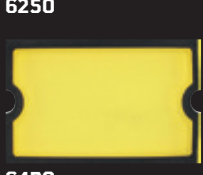

6480



6350



6160



6480



6330







140

WERKSTATTWAGEN – 5 SCHUBLADEN TOOL TROLLEY – 5 COMPARTMENTS

Stabile Stahlblechkonstruktion mit widerstandsfähiger Pulverbeschichtung.
Belastbarkeit je Schublade 45 kg.
Alle Schubladen mit Vollauszug und leichtgängigen, kugelgelagerten Führungsschienen.
2 Bock- und 2 Lenkrollen aus Polypropylen.
Handgriff zum leichten Rangieren.
Seitenbleche mit Halterungen für Zubehör.
PP-Kunststoffauflage mit Kleinteilefächern.

Robust sheet steel construction with high resistant powder coating.
Loading capacity per drawer 45 kg.
All drawers with full pullout function and ball-bearing drawer slides.
2 fixed castors and 2 swivel castors made of polypropylene.
Handle for easy shunting.
Side panels with brackets for equipment.
PP-plastic edition with small part bins.

Art.-No.	Inhalt Content	H x B x T (mm) H x W x L (mm)		
1400250	leer empty	970 x 670 x 470	62500	1
1400259	6010 6020 6040 6050 6070 6440	970 x 670 x 470	72950	1
1400260	6010 6020 6040 6050 6070 6180 6280 6290 6440	970 x 670 x 470	81940	1





142

WERKSTATTWAGEN – 7 SCHUBLADEN TOOL TROLLEY – 7 COMPARTMENTS

Stabile Stahlblechkonstruktion mit widerstandsfähiger Pulverbeschichtung.
Belastbarkeit je Schublade 45 kg.
Alle Schubladen mit Vollauszug und leichtgängigen, kugelgelagerten Führungsschienen.
2 Bock- und 2 Lenkrollen aus Polypropylen.
Handgriff zum leichten Rangieren.
Seitenbleche mit Halterungen für Zubehör.
PP-Kunststoffauflage mit Kleinteilefächern.

Robust sheet steel construction with high resistant powder coating.
Loading capacity per drawer 45 kg.
All drawers with full pullout function and ball-bearing drawer slides.
2 fixed castors and 2 swivel castors made of polypropylene.
Handle for easy shunting.
Side panels with brackets for equipment.
PP-plastic edition with small part bins.

Art.-No.	Inhalt Content	H x B x T (mm) H x W x L (mm)		
1420370	leer empty	970 x 670 x 470	66780	1
1420378	6010 6020 6040 6050 6070 6440	970 x 670 x 470	82430	1
1420379	6010 6020 6040 6050 6070 6180 6280 6290 6440	970 x 670 x 470	86218	1





143

WERKSTATTWAGEN – 5 SCHUBLADEN TOOL TROLLEY – 5 COMPARTMENTS



Stabile Stahlblechkonstruktion mit widerstandsfähiger Pulverbeschichtung.
Zuverlässiger Kantenschutz an allen Seiten.
Belastbarkeit je Schublade 35 kg.
Alle Schubladen mit Vollauszug und leichtgängigen, kugelgelagerten Führungsschienen.
NO-RISK-Auszugssperre gegen Kippen des Wagens.
2 Bock- und 2 Lenkrollen aus Polypropylen.
Handgriff zum leichten Rangieren.
Seitenbleche mit Schlüssellochung zur Erweiterung mit Zusatzhalterungen.
ABS-Kunststoffauflage mit Kleinteilefächern.
Inklusive 10 Schubladeneinteiler zur Organisation.

Robust sheet steel construction with high resistant powder coating.
 Reliable edge protection on all sides of the trolley.
 Loading capacity per drawer 35 kg.
 All drawers with full pullout function and ball-bearing drawer slides.
 NO-RISK-Output blockade against tilting the trolley.
 2 fixed castors and 2 swivel castors made of polypropylene.
 Handle for easy shunting.
 Side panels with key slot for extension with additional brackets.
 ABS-plastic edition with small part bins.
 Including 10 drawer separators for organization.

Art.-No.	Inhalt Content	H x B x T (mm) H x W x L (mm)		
1430250	leer empty	943 x 712 x 466	61500	1
1430251	6010 6020 6040 6050 6070 6440	943 x 712 x 466	77150	1
1430252	6010 6020 6040 6050 6070 6180 6280 6290 6440	943 x 712 x 466	82940	1





145

WERKSTATTWAGEN – 7 SCHUBLADEN TOOL TROLLEY – 7 COMPARTMENTS



Stabile Stahlblechkonstruktion mit widerstandsfähiger Pulverbeschichtung.
Zuverlässiger Kantenschutz an allen Seiten.
Belastbarkeit je Schublade 35 kg.
Alle Schubladen mit Vollauszug und leichtgängigen, kugelgelagerten Führungsschienen.
NO-RISK-Auszugssperre gegen Kippen des Wagens.
2 Bock- und 2 Lenkrollen aus Polypropylen.
Handgriff zum leichten Rangieren.
Seitenbleche mit Schlüssellochung zur Erweiterung mit Zusatzhalterungen.
ABS-Kunststoffauflage mit Kleinteilefächern.
Inklusive 10 Schubladeneinteiler zur Organisation.

Robust sheet steel construction with high resistant powder coating.
Reliable edge protection on all sides of the trolley.
Loading capacity per drawer 35 kg.
All drawers with full pullout function and ball-bearing drawer slides.
NO-RISK-Output blockade against tilting the trolley.
2 fixed castors and 2 swivel castors made of polypropylene.
Handle for easy shunting.
Side panels with key slot for extension with additional brackets.
ABS-plastic edition with small part bins.
Including 10 drawer separators for organization.

Art.-No.	Inhalt Content	H x B x T (mm) H x W x L (mm)		
1450270	leer empty	943 x 712 x 466	63500	1
1450271	6010 6020 6040 6050 6070 6440	943 x 712 x 466	79140	1
1450272	6010 6020 6040 6050 6070 6180 6280 6290 6440	943 x 712 x 466	92940	1



6400

MODUL 4 IN 1 DOPPELRING-RATSCHENSCHLÜSSEL MODULE 4 IN 1 DOUBLE-BOX GEAR WRENCH

Chrom-Vanadium Stahl
verchromt
gerade
3-tlg.
beidseitig umschaltbar
72 Zähne

Chrome-Vanadium steel
chrome plated
straight
3 pcs.
reversible on both sides
72 teeth

Art.-No.	Für For	 mm	L x B x H (mm) L x W x H (mm)		
6400000	140 142 143 145 3991 3993	8 x 10 x 12 x 13 9 x 11 x 14 x 15 16 x 17 x 18 x 19	114 x 268 x 38	754	1

Einzelteile entsprechen der DIN | parts according to DIN



6070

MODUL STIFTSCHLÜSSEL-SÄTZE MODULE HEXAGON KEY WRENCH SETS

Chrom-Vanadium Stahl
vernickelt | verchromt
17-tlg.

Chrome-Vanadium steel
nickel plated | chrome plated
17 pcs.

Sechskant-Stiftschlüssel-Satz 1,5 | 2 | 2,5 | 3 | 4 | 5 | 6 | 8 | 10 mm
TORX®-Stiftschlüssel-Satz mit Kugelkopf TX9 | TX10 | TX15 | TX20 | TX25 | TX27 | TX30 | TX40

Hexagon Key Wrench Set 1,5 | 2 | 2,5 | 3 | 4 | 5 | 6 | 8 | 10 mm
TORX® Key Wrench Set with Ballpoint TX9 | TX10 | TX15 | TX20 | TX25 | TX27 | TX30 | TX40



Art.-No.	Für For	L x B x H (mm) L x W x H (mm)		
6070000	140 142 143 145 3991 3993	114 x 268 x 38	936	1

Einzelteile entsprechen der DIN | parts according to DIN

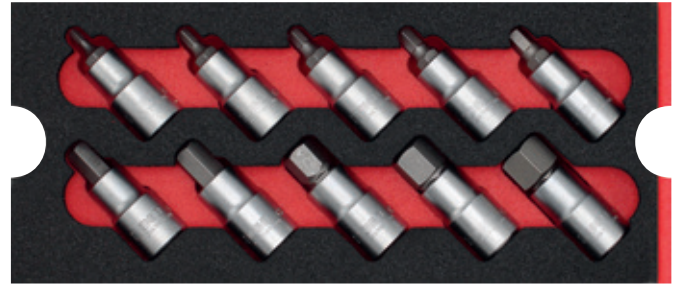

6100

MODUL INNENSECHSKANT-STECKSCHLÜSSEL-EINSÄTZE MODULE INSIDE HEXAGON SOCKETS

Chrom-Vanadium Stahl
verchromt
für Innensechskant-Schrauben
10-tlg.

12,5 1/2" 

Chrome-Vanadium steel
chrome plated
for inside hexagon screws
10 pcs.

Art.-No.	Für For	 mm	L x B x H (mm) L x W x H (mm)	 g	
6100000	140 142 143 145 3991 3993	4 5 6 7 8 10 12 14 17 19	114 x 268 x 38	1128	1

Einzelteile entsprechen der DIN | parts according to DIN



6200

MODUL INNENSECHSKANT-STECKSCHLÜSSEL-EINSÄTZE MODULE INSIDE HEXAGON SOCKETS



Chrom-Vanadium Stahl
verchromt
18-tlg.

6,3 1/4" 12,5 1/2" 

Chrome-Vanadium steel
chrome plated
18 pcs.

1/4" Innensechskant-Schraubendreher-Einsatz 2 | 2,5 | 3 | 4 | 5 | 6 mm
1/2" Innensechskant-Schraubendreher-Einsatz 6 | 7 | 8 | 10 | 12 | 14 mm
1/2" Innensechskant-Schraubendreher-Einsatz, lang 5 | 6 | 7 | 8 |
10 | 12 mm

1/4" Inside Hexagon Screwdriver Socket 2 | 2,5 | 3 | 4 | 5 | 6 mm
1/2" Inside Hexagon Screwdriver Socket 6 | 7 | 8 | 10 | 12 | 14 mm
1/2" Inside Hexagon Screwdriver Socket, long 5 | 6 | 7 | 8 |
10 | 12 mm

Art.-No.	Für For	L x B x H (mm) L x W x H (mm)	 g	
6200000	140 142 143 145 3991 3993	114 x 268 x 38	1960	1

Einzelteile entsprechen der DIN | parts according to DIN



6320

MODUL TX STECKSCHLÜSSEL-GARNITUR MODULE TX SOCKET SET

Chrom-Vanadium Stahl
verchromt
23-tlg.

1/4" TR Schraubendreher-Einsatz TR8 | TR10 | TR15 | TR20 | TR25 | TR27 | TR30
1/4" E-TX Schraubendreher-Einsatz E4 | E5 | E6 | E8
1/2" TX Schraubendreher-Einsatz TX40 | TX45 | TX50 | TX55 | TX60
1/2" E-TX Schraubendreher-Einsatz E10 | E12 | E14 | E18
TX Stiftschlüssel TX6 | TX8 | TX10



Chrome-Vanadium steel
chrome plated
23 pcs.

1/4" TR Screwdriver Socket TR8 | TR10 | TR15 | TR20 | TR25 | TR27 | TR30
1/4" E-TX Screwdriver Socket E4 | E5 | E6 | E8
1/2" TX Screwdriver Socket TX40 | TX45 | TX50 | TX55 | TX60
1/2" E-TX Screwdriver Socket E10 | E12 | E14 | E18
TX Key Wrench TX6 | TX8 | TX10

Art.-No.	Für For	L x B x H (mm) L x W x H (mm)		
6320000	140 142 143 145 3991 3993	114 x 268 x 38	1424	1

Einzelteile entsprechen der DIN | parts according to DIN



6210

MODUL XZN STECKSCHLÜSSEL-GARNITUR MODULE XZN SOCKET SET

Chrom-Vanadium Stahl
verchromt
18-tlg.

1/2" XZN Schraubendreher-Einsatz M5 | M6 | M8 | M10 | M12 | M14
1/2" XZN Schraubendreher-Einsatz, lang M6 | M8 | M9 | M10 | M12 | M14
1/2" Steckschlüssel-Einsatz, 12-kant 9 | 10 | 12 | 18 | 19 | 21 mm



Chrome-Vanadium steel
chrome plated
18 pcs.

1/2" XZN Screwdriver Socket M5 | M6 | M8 | M10 | M12 | M14
1/2" XZN Screwdriver Socket, long M6 | M8 | M9 | M10 | M12 | M14
1/2" Socket, 12-point 9 | 10 | 12 | 18 | 19 | 21 mm

Art.-No.	Für For	L x B x H (mm) L x W x H (mm)		
6210000	140 142 143 145 3991 3993	114 x 268 x 38	1860	1

Einzelteile entsprechen der DIN | parts according to DIN

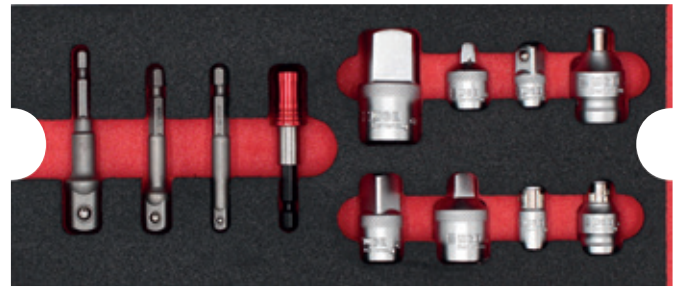

6420

MODUL ADAPTER-SET MODULE ADAPTOR SET

Chrom-Vanadium Stahl | verchromt / stahlgrau | 12-tlg.

- 1/4" Maschinen-Adapter, 1/4" innen, 1/4" außen
- 3/8" Maschinen-Adapter, 1/4" innen, 3/8" außen
- 1/2" Maschinen-Adapter, 1/4" innen, 1/2" außen
- 1/4" Bit-Adapter, 1/4" innen, 1/4" außen
- 3/8" Bit-Adapter, 3/8" innen, 1/4" außen
- 1/2" Bit-Adapter, 1/2" innen, 1/4" außen
- 1/4" Übergangsteil, 1/4" innen, 3/8" außen
- 3/8" Übergangsteil, 3/8" innen, 1/4" außen
- 3/8" Übergangsteil, 3/8" innen, 1/2" außen
- 1/2" Übergangsteil, 1/2" innen, 3/8" außen
- 1/2" Übergangsteil, 1/2" innen, 3/4" außen
- 1/4" Schnellwechsel-Bit-Halter

- 6,3
- 1/4"
- 10
- 3/8"
- 12,5
- 1/2"
-
-

Chrome-Vanadium steel | chrome plated / grey finished | 12 pcs.

- 1/4" Machinery Adaptor, 1/4" female, 1/4" male
- 3/8" Machinery Adaptor, 1/4" female, 3/8" male
- 1/2" Machinery Adaptor, 1/4" female, 1/2" male
- 1/4" Bit Adaptor, 1/4" female, 1/4" male
- 3/8" Bit Adaptor, 3/8" female, 1/4" male
- 1/2" Bit Adaptor, 1/2" female, 1/4" male
- 1/4" Adaptor, 1/4" female, 3/8" male
- 3/8" Adaptor, 3/8" female, 1/4" male
- 3/8" Adaptor, 3/8" female, 1/2" male
- 1/2" Adaptor, 1/2" female, 3/8" male
- 1/2" Adaptor, 1/2" female, 3/4" male
- 1/4" Quick-release Bit Holder

Art.-No.	Für For	L x B x H (mm) L x W x H (mm)		
6420000	140 142 143 145 3991 3993	114 x 268 x 38	932	1

Einzelteile entsprechen der DIN | parts according to DIN

6220

MODUL STECKSCHLÜSSEL-EINSÄTZE UND ADAPTER MODULE SCREWDRIVER SOCKETS AND ADAPTORS

Chrom-Vanadium Stahl | verchromt | 21-tlg.

- 1/2" TX Schraubendreher-Einsatz TX25 | TX27 | TX30 | TX40 | TX45 | TX50
- 1/2" E-TX Schraubendreher-Einsatz E10 | E12 | E14 | E16 | E18 | E20
- 1/2" Innensechskant-Schraubendreher-Einsatz 6 | 7 | 8 | 10 | 12 | 14 mm
- Übergangsteil 1/4" innen, 3/8" außen 25 mm
- Übergangsteil 1/2" innen, 3/4" außen 44 mm
- Übergangsteil 3/4" innen, 1/2" außen 44 mm

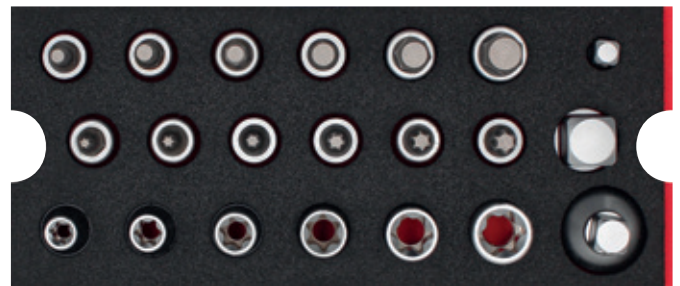

- 6,3
- 1/4"
- 10
- 3/8"
- 12,5
- 1/2"
- 20
- 3/4"
-
-
-
-

Chrome-Vanadium steel | chrome plated | 21 pcs.

- 1/2" TX Screwdriver Socket TX25 | TX27 | TX30 | TX40 | TX45 | TX50
- 1/2" E-TX Screwdriver Socket E10 | E12 | E14 | E16 | E18 | E20
- 1/2" Inside Hexagon Screwdriver Socket 6 | 7 | 8 | 10 | 12 | 14 mm
- Adaptor 1/4" female, 3/8" male 25 mm
- Adaptor 1/2" female, 3/4" male 44 mm
- Adaptor 3/4" female, 1/2" male 44 mm

Art.-No.	Für For	L x B x H (mm) L x W x H (mm)		
6220000	140 142 143 145 3991 3993	114 x 268 x 38	1596	1

Einzelteile entsprechen der DIN | parts according to DIN

6370

MODUL DURCHSTECK-STECKSCHLÜSSEL-GARNITUR 40 IN 1

MODULE GO-THROUGH SOCKET SET 40 IN 1

Chrom-Vanadium Stahl
verchromt
13-tlg.

Durchsteckknarre, 72 Zähne, 210 mm, mit Magnetscheibe
Verlängerung 19 mm x 75 mm
Adapter 19 mm x 1/2" für Einsatz als herkömmliche Knarre
Sonderprofil Durchsteck-Steckschlüssel-Einsatz 8 | 9 | 10 | 11 | 12 | 13 | 14 | 15 | 16 | 17 mm
Steckschlüssel-Einsätze auch verwendbar für: Zoll: 5/16 | 11/32 | 3/8 | 7/16 | 15/32 | 1/2 | 9/16 | 19/32 | 5/8 | 11/16"
E-TX: E10 | E11 | E12 | E14 | E16 | E18 | E20
XZN: 8 | 9 | 10 | 11 | 12 | 14 | 16

Art.-No.	Für For	L x B x H (mm) L x W x H (mm)		
6370000	140 142 143 145 3991 3993	114 x 268 x 38	1190	1



Chrome-Vanadium steel
chrome plated
13 pcs.

Go-Through Ratchet, 72 teeth, 210 mm, with magnetic disk
Extension Bar 19 mm x 75 mm
Adaptor 19 mm x 1/2" for using ratchet conventionally
Special profile Go-Through Socket 8 | 9 | 10 | 11 | 12 | 13 | 14 | 15 | 16 | 17 mm
Sockets also adaptable for: Inch: 5/16 | 11/32 | 3/8 | 7/16 | 15/32 | 1/2 | 9/16 | 19/32 | 5/8 | 11/16"
E-TX: E10 | E11 | E12 | E14 | E16 | E18 | E20
XZN: 8 | 9 | 10 | 11 | 12 | 14 | 16

6380

MODUL DURCHSTECK-DOPPELRING-RATSCHEN- SCHLÜSSEL-SATZ 28 IN 1

MODULE GO-THROUGH DOUBLE-BOX GEAR WRENCH SET 28 IN 1

Chrom-Vanadium Stahl | verchromt | 16-tlg.

Doppelring-Ratschenschlüssel mit:
Durchsteck-Steckschlüssel-Einsatz 6 x 8 | 9 x 10 | 11 x 12 | 13 x 15 | 16 x 17 mm
Durchsteck-Steckschlüssel-Einsatz 1/4" x 5/16" | 9/32" x 11/32" | 3/8" x 7/16" | 1/2" x 19/32" | 5/8" x 11/16" | 9/16" x 3/4"
Adapter 1/4" | 3/8" | 1/2" für Einsatz als herkömmliche Knarre
Bit-Adapter 1/4"

Art.-No.	Für For	L x B x H (mm) L x W x H (mm)		
6380000	140 142 143 145 3991 3993	114 x 268 x 38	1232	1

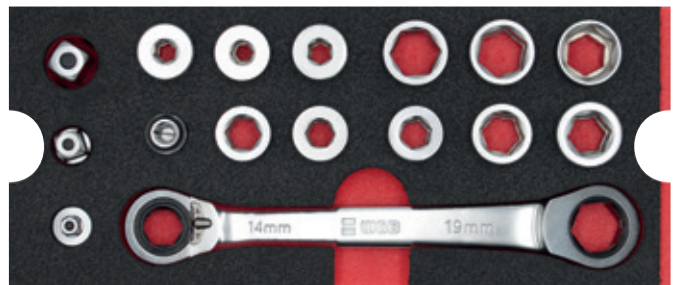

Chrome-Vanadium steel | chrome plated | 16 pcs.

Double-Box Gear Wrench with:
Go-Through Socket 6 x 8 | 9 x 10 | 11 x 12 | 13 x 15 | 16 x 17 mm
Go-Through Socket 1/4" x 5/16" | 9/32" x 11/32" | 3/8" x 7/16" | 1/2" x 19/32" | 5/8" x 11/16" | 9/16" x 3/4"
Adaptor 1/4" | 3/8" | 1/2" for using ratchet conventionally
Bit Adaptor 1/4"



6050

MODUL STECKSCHLÜSSEL-GARNITUR MODULE SOCKET SET

Chrom-Vanadium Stahl | verchromt | 36-tlg.

- 1/4" Steckschlüssel-Einsatz, 6-kant 4 | 4,5 | 5 | 5,5 | 6 | 6,5 | 7 | 8 | 9 | 10 | 11 | 12 | 13 mm
- 1/4" PH Schraubendreher-Einsatz PH1 | PH2
- 1/4" Schraubendreher-Einsatz 4 | 5,5 mm
- 1/4" Innensechskant-Schraubendreher-Einsatz 3 | 4 | 5 | 6 mm
- 1/4" TR Schraubendreher-Einsatz TR20 | TR25 | TR27 | TR30
- 1/4" Kardan-Gelenk
- 1/4" Verlängerung 50 | 100 mm
- 1/4" Adapter-Gleitstück 3/8" x 1/4"
- 1/4" Steckgriff mit 1/4" Antriebsvierkant
- 1/4" Hebelumschaltknarre, 72 Zähne 140 mm
- Sechskant-Stiftschlüssel 1,25 | 1,5 | 2 | 2,5 | 3 mm



Chrome-Vanadium steel | chrome plated | 36 pcs.

- 1/4" Socket, 6-point 4 | 4,5 | 5 | 5,5 | 6 | 6,5 | 7 | 8 | 9 | 10 | 11 | 12 | 13 mm
- 1/4" PH Screwdriver Socket PH1 | PH2
- 1/4" Screwdriver Socket 4 | 5,5 mm
- 1/4" Inside Hexagon Screwdriver Socket 3 | 4 | 5 | 6 mm
- 1/4" TR Screwdriver Socket TR20 | TR25 | TR27 | TR30
- 1/4" Universal Joint
- 1/4" Extension Bar 50 | 100 mm
- 1/4" Sliding Adaptor 3/8" x 1/4"
- 1/4" Spinner Handle with 1/4" Square Coupler
- 1/4" Reversible Ratchet, lever type, 72 teeth 140 mm
- Hexagon Key Wrench 1,25 | 1,5 | 2 | 2,5 | 3 mm

Art.-No.	Für For	L x B x H (mm) L x W x H (mm)	 g	
6050000	140 142 143 145 3991 3993	117 x 268 x 38	1887	1





6360

MODUL KRAFT-SCHONEINSÄTZE MODULE PROTECTIVE IMPACT SOCKETS

lange Ausführung
Chrom-Molybdän Stahl
kunststoffummantelt
5-tlg.



long type
Chrome-Molybdenum steel
plastic coated
5 pcs.

Art.-No.	Für For	 mm	L x B x H (mm) L x W x H (mm)	 g	
6360000	140 142 143 145 3991 3993	15 17 19 21 22	114 x 268 x 38	1160	1

Einzelteile entsprechen der DIN | parts according to DIN



6350

MODUL KRAFT-EINSÄTZE MODULE IMPACT SOCKETS

Chrom-Molybdän Stahl
schwarz
7-tlg.

Kraft-Einsatz 13 | 17 | 19 | 21 | 24 mm
1/2" Bit-Adapter, 1/4" innen, 1/2" außen
1/2" Maschinen-Adapter 1/4" innen, 1/2" außen



Chrome-Molybdenum steel
black
7 pcs.

Impact Socket 13 | 17 | 19 | 21 | 24 mm
1/2" Bit Adaptor, 1/4" female, 1/2" male
1/2" Machinery Adaptor 1/4" female, 1/2" male

Art.-No.	Für For	L x B x H (mm) L x W x H (mm)	g	
6350000	140 142 143 145 3991 3993	114 x 268 x 38	1160	1

Einzelteile entsprechen der DIN | parts according to DIN



6330

MODUL TX KRAFT-SCHRAUBENDREHER-EINSÄTZE MODULE TX IMPACT SOCKETS

Chrom-Molybdän Stahl
schwarz
8-tlg.



Chrome-Molybdenum steel
black
8 pcs.

Art.-No.	Für For	mm	L x B x H (mm) L x W x H (mm)	g	
6330000	140 142 143 145 3991 3993	TX30 TX40 TX45 TX50 TX55 TX60 TX70 TX80	114 x 268 x 38	1160	1

Einzelteile entsprechen der DIN | parts according to DIN



6340

MODUL INNENSECHSKANT-KRAFT-EINSÄTZE MODULE INSIDE HEXAGON IMPACT SOCKETS

Chrom-Molybdän Stahl
schwarz
8-tlg.



Chrome-Molybdenum steel
black
8 pcs.

Art.-No.	Für For	mm	L x B x H (mm) L x W x H (mm)	g	
6340000	140 142 143 145 3991 3993	5 6 8 10 12 14 17 19	114 x 268 x 38	1160	1

Einzelteile entsprechen der DIN | parts according to DIN



6440

MODUL SCHRAUBENDREHER MODULE SCREWDRIVER

Chrom-Vanadium Stahl
S2-Profi-Stahl
verchromt
2-Komponentenheft
durchgehende Klinge
mit Sechskantansatz
mit Schlagkappe
4-tlg.



Chrome-Vanadium steel
S2 Professional steel
chrome plated
two component handle
protruding blade
with hexagon bolster
with hammer cap
4 pcs.

Werkstatt-Schraubendreher 3 x 75 | 5 x 75 mm
PH Schraubendreher PH0 | PH1

Engineers Screwdriver 3 x 75 | 5 x 75 mm
PH Screwdriver PH0 | PH1

Art.-No.	Für For	L x B x H (mm) L x W x H (mm)	g	
6440000	140 142 143 145 3991 3993	114 x 268 x 38	980	1

Einzelteile entsprechen der DIN | parts according to DIN



6060

MODUL RATSCHENSCHRAUBENDREHER-GARNITUR MODULE SCREWDRIVER BIT SET

Chrom-Vanadium Stahl
verchromt
58-tlg.

Bit-Halter mit 2-Komponentenheft, 180° schwenkbar,
45° Sicherheitsarretierung

Bit-Adapter

2x Bits für PH-Schrauben PH0 | PH1 | PH2 | PH3

2x Bits für PZ-Schrauben PZ0 | PZ1 | PZ2 | PZ3

Bit für Schlitzschrauben 3 | 4 | 4,5 | 5 | 6 | 7 | 8 mm

Bit für Innensechskant-Schrauben 1,5 | 2 | 2,5 | 3 | 4 | 5 | 6 mm

2x Bit für TORX®-Schrauben TX5 | TX6 | TX7 | TX8 | TX9 | TX10 | TX15 |
TX20 | TX25 | TX30 | TX40

Bit für XZN-Schrauben M4 | M5 | M6

Maschinen-Adapter magnetisch, mit Arretierungshilfe



Chrome-Vanadium steel
chrome plated
58 pcs.

Bit Holder with two component handle, 180° swivelling,
45° safety locking mechanism

Bit Adaptor

2x Bits for PH screws PH0 | PH1 | PH2 | PH3

2x Bits for PZ screws PZ0 | PZ1 | PZ2 | PZ3

Bit for slotted screws 3 | 4 | 4,5 | 5 | 6 | 7 | 8 mm

Bit for inside hexagon screws 1,5 | 2 | 2,5 | 3 | 4 | 5 | 6 mm

2x Bits for TORX® screws TX5 | TX6 | TX7 | TX8 | TX9 | TX10 | TX15 |
TX20 | TX25 | TX30 | TX40

Bit for XZN screws M4 | M5 | M6

magnetic Machinery Adaptor, with locking mechanism

Art.-No.	Für For	L x B x H (mm) L x W x H (mm)		
6060000	140 142 143 145 3991 3993	114 x 268 x 38	1164	1

Einzelteile entsprechen der DIN | parts according to DIN



6450

MODUL LEER
MODULE EMPTY

1 Leerfach

1 empty compartment

Art.-No.	Für For	L x B x H (mm) L x W x H (mm)	 g	
9302070	140 142 143 145 3991 3993	114 x 268 x 38	47	1

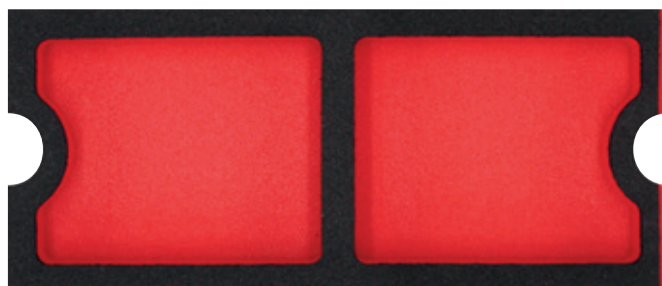



6460

MODUL LEER
MODULE EMPTY

2 Leerfächer

2 empty compartments

Art.-No.	Für For	L x B x H (mm) L x W x H (mm)	 g	
9302080	140 142 143 145 3991 3993	114 x 268 x 38	48	1

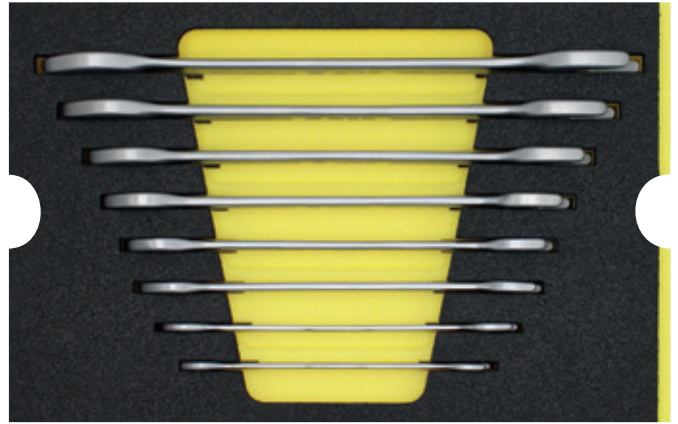

6140

MODUL DOPPELMAULSCHLÜSSEL MODULE DOUBLE OPEN ENDED SPANNER

Chrom-Vanadium Stahl
verchromt
8-tlg.

Chrome-Vanadium steel
chrome plated
8 pcs.

Art.-No.	Für For	mm	L x B x H (mm) L x W x H (mm)	g	
6140000	140 142 143 145 3991 3993	6 x 7 8 x 9 10 x 11 12 x 13 14 x 15 16 x 17 18 x 19 20 x 22	171 x 268 x 38	873	1

Einzelteile entsprechen der DIN | parts according to DIN

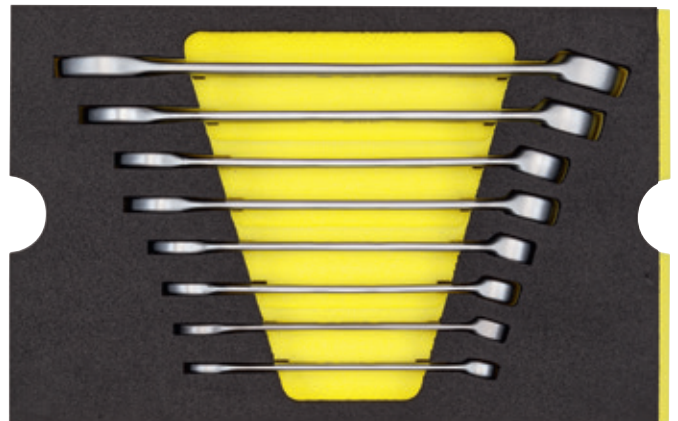

6490

MODUL RINGMAULSCHLÜSSEL MODULE COMBINATION SPANNER

Chrom-Vanadium Stahl
verchromt
8-tlg.

Chrome-Vanadium steel
chrome plated
8 pcs.

Art.-No.	Für For	mm	L x B x H (mm) L x W x H (mm)	g	
6490000	140 142 144 145 3991 3993	8 9 10 11 13 14 17 19	171 x 268 x 38	555	1

Einzelteile entsprechen der DIN | parts according to DIN

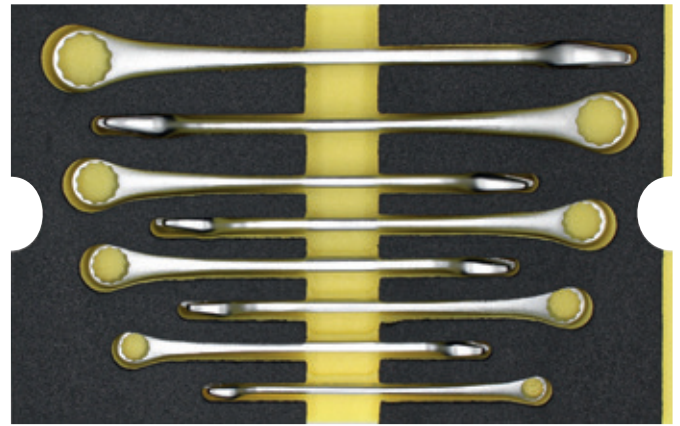

6410

MODUL HOT!FORCE RINGMAULSCHLÜSSEL MODULE HOT!FORCE COMBINATION SPANNER

Chrom-Vanadium Stahl
verchromt
8-tlg.

Chrome-Vanadium steel
chrome plated
8 pcs.

Siehe Kapitel 02

224 HOT!FORCE Ringmaulschlüssel

Der Toolbox Ergonomie Tipp

See chapter 02

224 HOT!FORCE Combination Spanner

The Toolbox Ergonomics Tip

Art.-No.	Für For	mm	L x B x H (mm) L x W x H (mm)	g	
6410080	140 142 143 145 3991 3993	8 10 12 13 14 15 17 19	171 x 268 x 38	1117	1

Einzelteile entsprechen der DIN | parts according to DIN



6190

MODUL RINGMAULSCHLÜSSEL MIT RATSCHKE MODULE COMBINATION GEAR WRENCH

Chrom-Vanadium Stahl
verchromt
5-tlg.

Chrome-Vanadium steel
chrome plated
5 pcs.

gerade
72 Zähne

straight
72 teeth

Art.-No.	Für For	mm	L x B x H (mm) L x W x H (mm)	g	
6190000	140 142 143 145 3991 3993	8 10 13 17 19	171 x 268 x 38	836	1

Einzelteile entsprechen der DIN | parts according to DIN



6180

MODUL RINGMAULSCHLÜSSEL MIT STOPRING MODULE COMBINATION GEAR WRENCH WITH STOPRING

Chrom-Vanadium Stahl
verchromt
5-tlg.

umschaltbar
abgewinkelt
72 Zähne

Chrome-Vanadium steel
chrome plated
5 pcs.

reversible
offset
72 teeth

Art.-No.	Für For	mm	L x B x H (mm) L x W x H (mm)		
6180000	140 142 143 145 3991 3993	8 10 13 17 19	171 x 268 x 38	1005	1

Einzelteile entsprechen der DIN | parts according to DIN

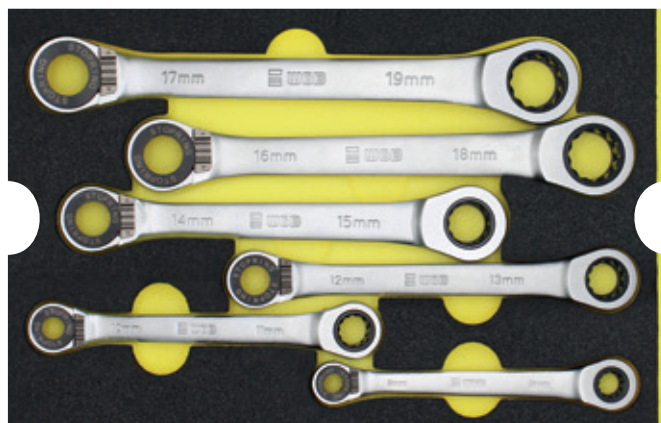

6160

MODUL DOPPELRING-RATSCHENSCHLÜSSEL MIT STOPRING MODULE DOUBLE-BOX GEAR WRENCH WITH STOPRING

Chrom-Vanadium Stahl
verchromt
6-tlg.

beidseitig umschaltbar
abgewinkelt
72 Zähne

Chrome-Vanadium steel
chrome plated
6 pcs.

reversible on both sides
offset
72 teeth

Art.-No.	Für For	mm	L x B x H (mm) L x W x H (mm)		
6160000	140 142 143 145 3991 3993	8 x 9 10 x 11 12 x 13 14 x 15 16 x 18 17 x 19	171 x 268 x 38	1025	1

Einzelteile entsprechen der DIN | parts according to DIN

6090

MODUL STIFTSCHLÜSSEL-SÄTZE MODULE HEXAGON KEY WRENCH SETS

Chrom-Vanadium Stahl
vernickelt
19-tlg.

Sechskant-Stiftschlüssel-Satz mit Kugelkopf 1,5 | 2 | 2,5 | 3 | 4 | 5 | 6 | 8 | 10 mm

Sechskant-Stiftschlüssel-Satz 0,05 | 1/16 | 5/64 | 3/32 | 1/8 | 5/32 | 3/16 | 7/32 | 1/4 | 5/16"

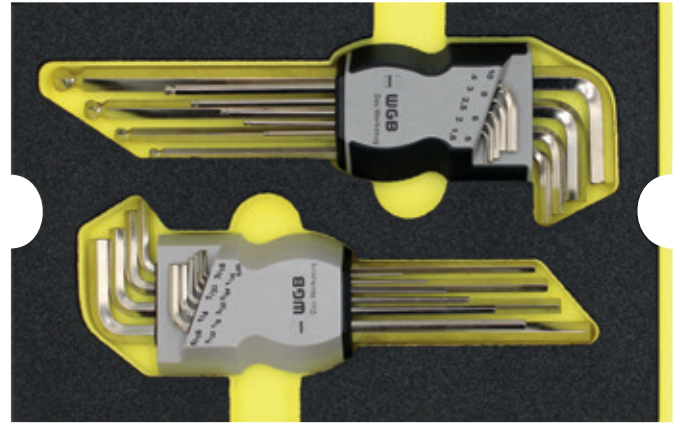

Chrome-Vanadium steel
nickel plated
19 pcs.

Hexagon Key Wrench Set with Ballpoint 1,5 | 2 | 2,5 | 3 | 4 | 5 | 6 | 8 | 10 mm

Hexagon Key Wrench Set 0,05 | 1/16 | 5/64 | 3/32 | 1/8 | 5/32 | 3/16 | 7/32 | 1/4 | 5/16"

Art.-No.	Für For	L x B x H (mm) L x W x H (mm)	 g	
6090000	140 142 143 145 3991 3993	171 x 268 x 38	1128	1

Einzelteile entsprechen der DIN | parts according to DIN

6280

MODUL STIFTSCHLÜSSEL-SÄTZE MODULE HEXAGON KEY WRENCH SETS

S2-Profi Stahl
verchromt
18-tlg.

Sicherheits-Stiftschlüssel-Satz 1,5 | 2 | 2,5 | 3 | 4 | 5 | 6 | 8 | 10 mm

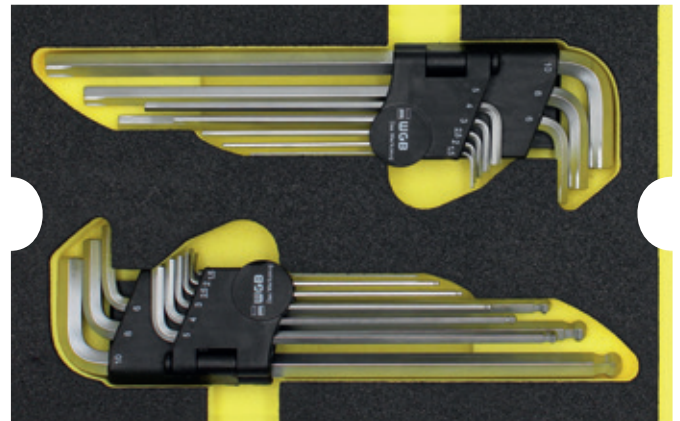

Grip-Stiftschlüssel-Satz 1,5 | 2 | 2,5 | 3 | 4 | 5 | 6 | 8 | 10 mm



S2 Professional steel
chrome plated
18 pcs.

Safety Hexagon Key Wrench Set 1,5 | 2 | 2,5 | 3 | 4 | 5 | 6 | 8 | 10 mm

Grip Hexagon Key Wrench Set 1,5 | 2 | 2,5 | 3 | 4 | 5 | 6 | 8 | 10 mm

Art.-No.	Für For	L x B x H (mm) L x W x H (mm)	 g	
6280000	140 142 143 145 3991 3993	171 x 268 x 38	896	1

Einzelteile entsprechen der DIN | parts according to DIN

6270

MODUL STIFTSCHLÜSSEL-SÄTZE MODULE KEY WRENCH SETS

Chrom-Vanadium Stahl
verchromt | schwarz
18-tlg.

Sechskant-Stiftschlüssel-Satz mit Kugelkopf 1,5 | 2 | 2,5 | 3 | 4 | 5 | 6 | 8 | 10 mm
TORX®-Stiftschlüssel-Satz TX10 | TX15 | TX20 | TX25 | TX27 | TX30 | TX40 | TX45 | TX50



Chrome-Vanadium steel
chrome plated | black
18 pcs.

Hexagon Key Wrench Set with Ballpoint 1,5 | 2 | 2,5 | 3 | 4 | 5 | 6 | 8 | 10 mm
TORX® Key Wrench Set TX10 | TX15 | TX20 | TX25 | TX27 | TX30 | TX40 | TX45 | TX50

Art.-No.	Für For	L x B x H (mm) L x W x H (mm)	 g	
6270000	140 142 143 145 3991 3993	171 x 268 x 38	816	1

Einzelteile entsprechen der DIN | parts according to DIN

6260

MODUL MONTAGEZANGEN MODULE CIRCLIP PLIERS

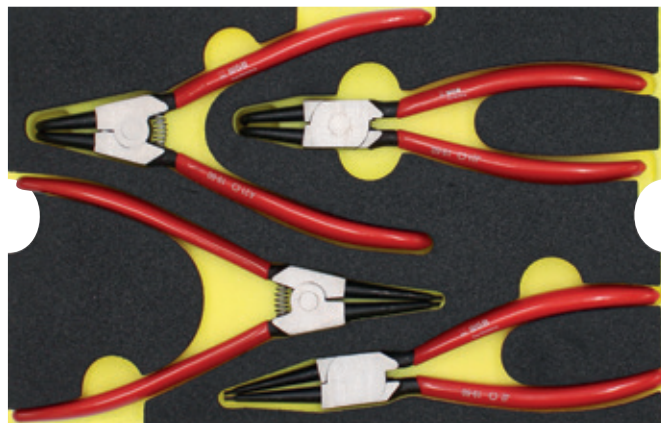

Kopf poliert
PVC-getauchte Griffe
4-tlg.

Montagezange für Außensicherungsringe A2 | A21
Montagezange für Innensicherungsringe J2 | J21



head polished
PVC-dip-coated handle
4 pcs.

Circlip Pliers for external retaining rings A2 | A21
Circlip Pliers for internal retaining rings J2 | J21

Art.-No.	Für For	L x B x H (mm) L x W x H (mm)	 g	
6260000	140 142 143 145 3991 3993	171 x 268 x 38	1000	1

Einzelteile entsprechen der DIN | parts according to DIN

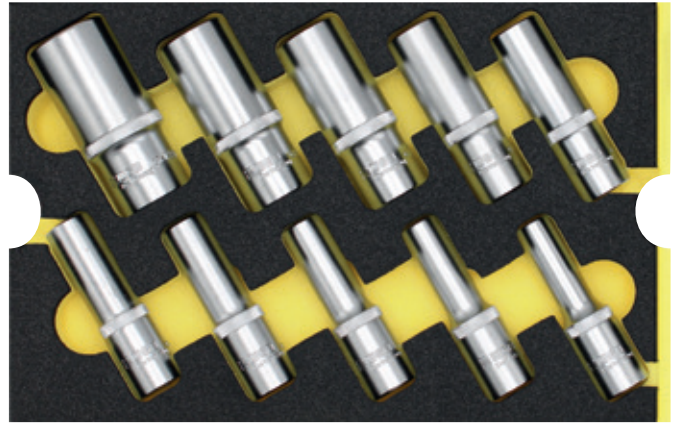

6120

**MODUL STECKSCHLÜSSEL-EINSÄTZE,
LANGE AUSFÜHRUNG**
MODULE SOCKETS, LONG

Chrom-Vanadium Stahl
verchromt
10-tlg.

12,5 1/2"

Chrome-Vanadium steel
chrome plated
10 pcs.

Art.-No.	Für For	mm	L x B x H (mm) L x W x H (mm)		
6120000	140 142 143 145 3991 3993	10 11 12 13 14 17 19 22 24 27	171 x 268 x 38	1908	1

Einzelteile entsprechen der DIN | parts according to DIN

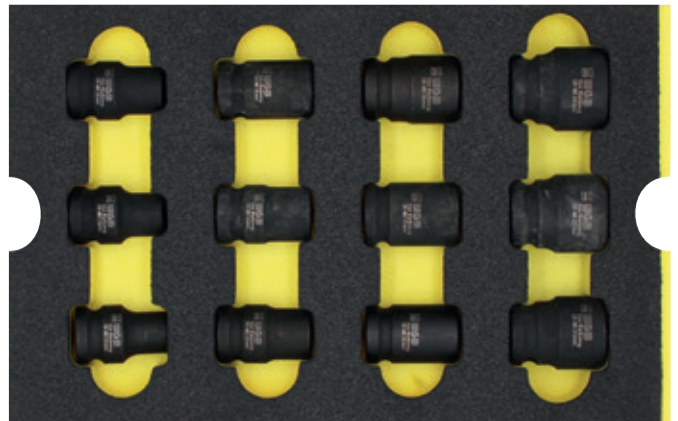

6130

MODUL KRAFT-EINSÄTZE
MODULE IMPACT SOCKETS

Chrom-Molybdän Stahl
schwarz
12-tlg.

12,5 1/2"

Chrome-Molybdenum steel
black
12 pcs.

Art.-No.	Für For	mm	L x B x H (mm) L x W x H (mm)		
6130000	140 142 143 145 3991 3993	10 11 12 13 14 15 16 17 19 21 22 24	171 x 268 x 38	1218	1

Einzelteile entsprechen der DIN | parts according to DIN

6030

MODUL SCHRAUBENDREHER MODULE SCREWDRIVER

S2-Profi-Stahl | verchromt
2-Komponentenheft
durchgehende Klinge
mit Sechskantansatz
mit Schlagkappe
7-tlg.

Werkstatt-Schraubendreher 3 | 5 | 6 mm
Vergaser-Schraubendreher 6 mm
PH Schraubendreher PH1 | PH2
PH Vergaser-Werkstatt-Schraubendreher PH2

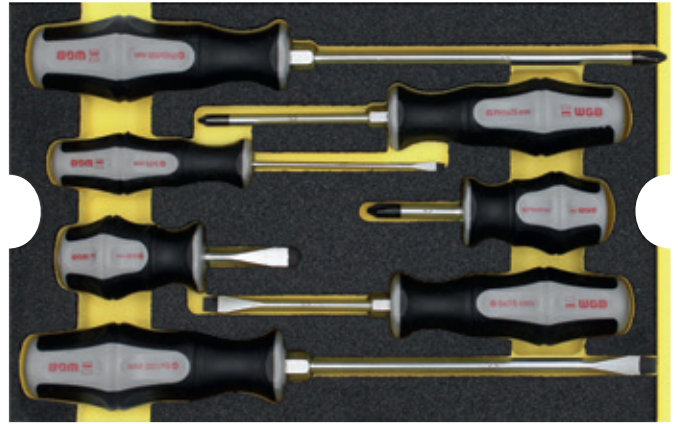

S2 Professional steel | chrome plated
two component handle
protruding blade
with hexagon bolster
with hammer cap
7 pcs.

Engineers Screwdriver 3 | 5 | 6 mm
Stubby Engineers Screwdriver 6 mm
PH Screwdriver PH1 | PH2
PH Stubby Screwdriver PH2

Art.-No.	Für For	L x B x H (mm) L x W x H (mm)	 g	
6030000	140 142 143 145 3991 3993	171 x 268 x 38	980	1

Einzelteile entsprechen der DIN | parts according to DIN

6250

MODUL TX SCHRAUBENDREHER MODULE TX SCREWDRIVERS

Molybdän-Vanadium-Stahl
verchromt mit schwarzer Spitze
2-Komponentenheft mit Aufhängeloch
6-tlg.

TX Schraubendreher TX8 | TX10 | TX15 | TX20 | TX25 | TX27

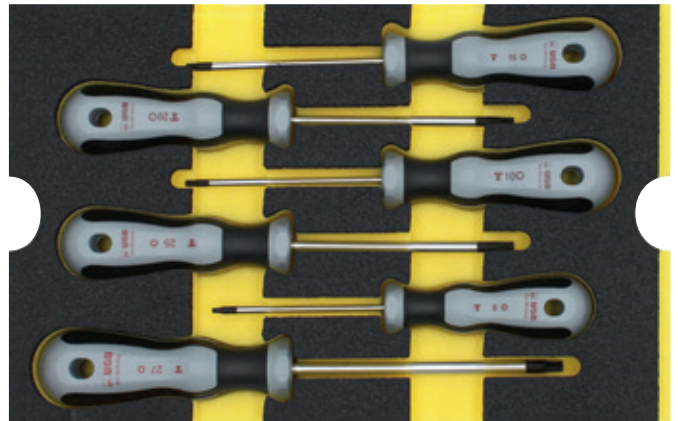

Molybdenum-Vanadium steel
chrome plated with black tip
two component handle with hanging hole
6 pcs.

TX Screwdriver TX8 | TX10 | TX15 | TX20 | TX25 | TX27

Art.-No.	Für For	L x B x H (mm) L x W x H (mm)	 g	
6250000	140 142 143 145 3991 3993	171 x 268 x 38	624	1

6470

MODUL LEER
MODULE EMPTY

1 Leerfach



1 empty compartment

Art.-No.	Für For	L x B x H (mm) L x W x H (mm)	 g	
9302210	140 142 143 145 3991 3993	171 x 268 x 38	68	1

6480

MODUL LEER
MODULE EMPTY

2 Leerfächer



2 empty compartments

Art.-No.	Für For	L x B x H (mm) L x W x H (mm)	 g	
9302220	140 142 143 145 3991 3993	171 x 268 x 38	75	1

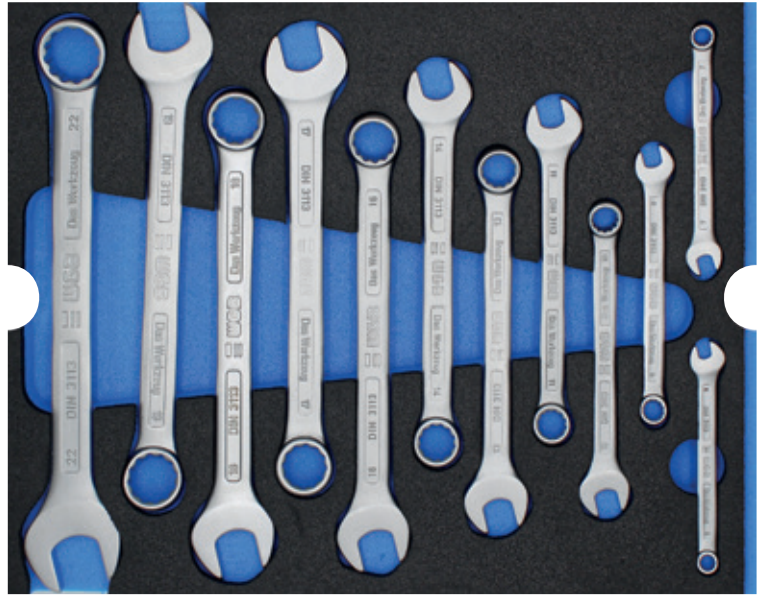

6010

MODUL RINGMAULSCHLÜSSEL MODULE COMBINATION SPANNER

Chrom-Vanadium Stahl | verchromt | 12-tlg.

Chrome-Vanadium steel | chrome plated | 12 pcs.

Art.-No.	Für For	mm	L x B x H (mm) L x W x H (mm)	g	
6010000	140 142 143 145 3991 3993	6 7 8 10 11 13 14 16 17 18 19 22	342 x 268 x 38	1460	1

Einzelteile entsprechen der DIN | parts according to DIN

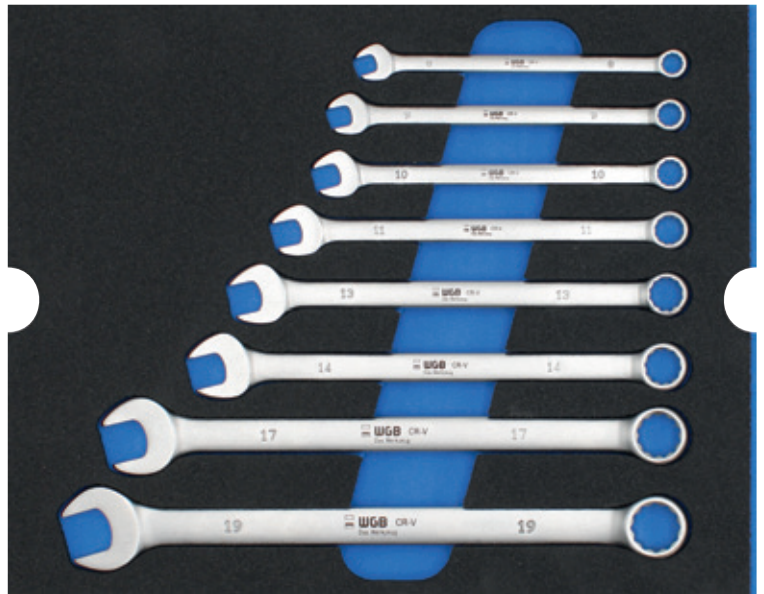

6170

MODUL RINGMAULSCHLÜSSEL EXTRA LANG MODULE COMBINATION SPANNER EXTRA LONG

Chrom-Vanadium Stahl | verchromt | 8-tlg.

Chrome-Vanadium steel | chrome plated | 8 pcs.

Art.-No.	Für For	mm	L x B x H (mm) L x W x H (mm)	g	
6170000	140 142 143 145 3991 3993	8 9 10 11 13 14 17 19	342 x 268 x 38	908	1

Einzelteile entsprechen der DIN | parts according to DIN



6150

MODUL RINGMAULSCHLÜSSEL MODULE COMBINATION SPANNER

Chrom-Vanadium Stahl | verchromt | 12-tlg.

Chrome-Vanadium steel | chrome plated | 12 pcs.

Art.-No.	Für For	mm	L x B x H (mm) L x W x H (mm)	g	
6150000	140 142 143 145 3991 3993	6 7 8 10 11 13 14 16 17 18 19 22	342 x 268 x 38	1501	1

Einzelteile entsprechen der DIN | parts according to DIN



6080

MODUL DOPPELRINGSCHLÜSSEL MODULE DOUBLE ENDED RING SPANNER

Chrom-Vanadium Stahl | verchromt | 8-tlg.

Chrome-Vanadium steel | chrome plated | 8 pcs.

Art.-No.	Für For	mm	L x B x H (mm) L x W x H (mm)	g	
6080000	140 142 143 145 3991 3993	6 x 7 8 x 9 10 x 11 12 x 13 14 x 15 16 x 17 18 x 19 20 x 22	342 x 268 x 38	1275	1

Einzelteile entsprechen der DIN | parts according to DIN

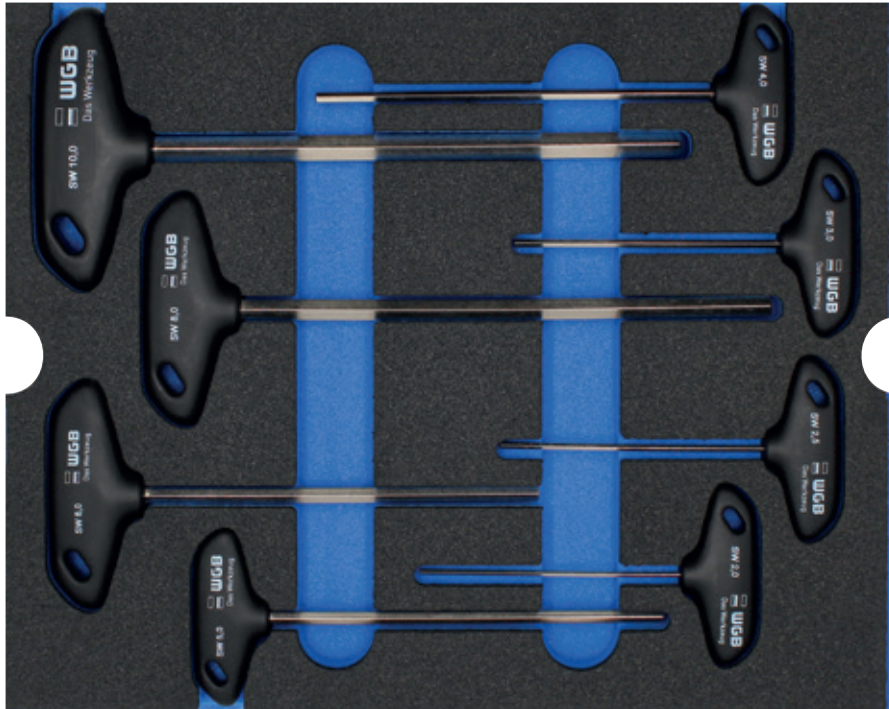

6390

MODUL SECHSKANT-STIFTSCHLÜSSEL MIT QUERGRIFF MODULE T-HANDLE HEXAGON KEY WRENCH



Chrom-Vanadium Stahl
vernickelt
Kunststoffquergriff mit Aufhängeloch
8-tlg.

Chrome-Vanadium steel
nickel plated
plastic T-handle with hanging hole
8 pcs.

Art.-No.	Für For	mm	L x B x H (mm) L x W x H (mm)	g	
6390000	140 142 143 145 3991 3993	2 x 90 2,5 x 100 3 x 100 4 x 150 5 x 150 6 x 150 8 x 200 10 x 200	342 x 268 x 38	845	1

Einzelteile entsprechen der DIN | parts according to DIN



6430

MODUL STECKSCHLÜSSEL-GARNITUR MODULE SOCKET SET

Chrom-Vanadium Stahl
verchromt
55-tlg.

- 3/8" Steckschlüssel-Einsatz, 6-kant 6 | 7 | 8 | 10 | 11 | 12 | 13 | 14 | 15 | 16 | 17 | 18 | 19 | 21 | 22 | 24 mm
- 3/8" Verlängerung 75 | 150 mm
- 3/8" Gleitstück 1/2" innen x 3/8" außen
- 3/8" Kardan-Gelenk
- 3/8" Zündkerzen-Einsatz 16 | 18 | 21 mm
- 3/8" Innensechskant-Schraubendreher-Einsatz 3 | 4 | 5 | 6 | 8 | 10 mm
- 3/8" PZ Schraubendreher-Einsatz PZ1 | PZ2 | PZ3
- 3/8" PH Schraubendreher-Einsatz PH1 | PH2 | PH3
- 3/8" Schraubendreher-Einsatz 4 | 5,5 | 7 mm
- 3/8" TX Schraubendreher-Einsatz TX10 | TX15 | TX20 | TX25 | TX27 | TX30 | TX40 | TX45
- 3/8" Hebelumschaltknarre, 72 Zähne
- Sechskant-Stiftschlüssel-Satz 1,5 | 2 | 2,5 | 3 | 4 | 5 | 5,5 | 6 mm



Chrome-Vanadium steel
chrome plated
55 pcs.

- 3/8" Socket, 6-point 6 | 7 | 8 | 10 | 11 | 12 | 13 | 14 | 15 | 16 | 17 | 18 | 19 | 21 | 22 | 24 mm
- 3/8" Extension Bar 75 | 150 mm
- 3/8" Sliding Adaptor 1/2" female x 3/8" male
- 3/8" Universal Joint
- 3/8" Spark Plug Socket 16 | 18 | 21 mm
- 3/8" Inside Hexagon Screwdriver Socket 3 | 4 | 5 | 6 | 8 | 10 mm
- 3/8" PZ Screwdriver Socket PZ1 | PZ2 | PZ3
- 3/8" PH Screwdriver Socket PH1 | PH2 | PH3
- 3/8" Screwdriver Socket 4 | 5,5 | 7 mm
- 3/8" TX Screwdriver Socket TX10 | TX15 | TX20 | TX25 | TX27 | TX30 | TX40 | TX45
- 3/8" Reversible Ratchet, lever type, 72 teeth
- Hexagon Key Wrench 1,5 | 2 | 2,5 | 3 | 4 | 5 | 5,5 | 6 mm

Art.-No.	Für For	L x B x H (mm) L x W x H (mm)		
6430000	140 142 143 145 3991 3993	342 x 268 x 38	1458	1

Einzelteile entsprechen der DIN | parts according to DIN



6020

MODUL STECKSCHLÜSSEL-GARNITUR MODULE SOCKET SET

Chrom-Vanadium Stahl
verchromt
29-tlg.

- 1/2" Steckschlüssel-Einsatz, 6-kant, 8 | 9 | 10 | 11 | 12 | 13 | 14 | 15 | 16 | 17 | 18 | 19 | 20 | 21 | 22 | 24 | 27 | 30 | 32 mm
- 1/2" Steckschlüssel-Einsatz, 6-kant, lange Ausführung, 10 | 13 | 17 mm
- 1/2" Zündkerzen-Einsatz 16 | 21 mm
- 1/2" Kardan-Gelenk
- 1/2" Verlängerung 125 | 250 mm
- 1/2" Übergangsteil 3/8" x 1/2"
- 1/2" Hebelumschaltknarre, 72 Zähne 250 mm



Chrome-Vanadium steel
chrome plated
29 pcs.

- 1/2" Socket, 6-point 8 | 9 | 10 | 11 | 12 | 13 | 14 | 15 | 16 | 17 | 18 | 19 | 20 | 21 | 22 | 24 | 27 | 30 | 32 mm
- 1/2" Socket, 6-point, long, 10 | 13 | 17 mm
- 1/2" Spark Plug Socket 16 | 21 mm
- 1/2" Universal Joint
- 1/2" Extension Bar 125 | 250 mm
- 1/2" Sliding T-Adaptor 3/8" x 1/2"
- 1/2" Reversible Ratchet, lever type, 72 teeth 250 mm

Art.-No.	Für For	L x B x H (mm) L x W x H (mm)		
6020000	140 142 143 145 3991 3993	342 x 268 x 38	6368	1

Einzelteile entsprechen der DIN | parts according to DIN



6510

MODUL STECKSCHLÜSSEL-GARNTITUR MODULE GO-THROUGH SOCKET SET

Chrom-Vanadium Stahl
verchromt
47-tlg.

mit Multifunktionsnüssen für 137 Anwendungen

- Durchsteck-Hebelumschaltknarre 1/4" | 3/8" | 1/2" (13 | 19 | 22 mm)
- Verlängerung 1/4" | 3/8" | 1/2" (13 | 19 | 22 mm), Länge 75 mm
- Adapter auf 1/4" | 3/8" | 1/2"
- Schnellwechsel-Adapter 4-kant auf 1/4" | 3/8" | 1/2"
- Durchsteck-Steckschlüssel-Einsätze 1/4" (13 mm) 4,5 | 5 | 5,5 | 6 | 7 | 8 | 9 | 10 | 11 mm
- Durchsteck-Steckschlüssel-Einsätze 3/8" (19 mm) 10 | 11 | 12 | 13 | 14 | 15 | 16 | 17 | 18 | 19 mm
- Durchsteck-Steckschlüssel-Einsätze 1/2" (22 mm) 19 | 20 | 21 | 22 | 23 | 24 mm
- 1/4" PH Steckschlüssel-Einsatz PH1 | PH2
- 1/4" TX Steckschlüssel-Einsatz TX10 | TX15
- 1/4" Schraubendreher-Einsatz 3 | 4 | 6 mm
- 1/4" Innensechskant-Schraubendreher-Einsatz 4 | 5 | 6 mm

6,3 1/4"

10 3/8" 12,5 1/2" 

Chrome-Vanadium steel
chrome plated
47 pcs.

with multifunction sockets for 137 applications

- Go-Through Reversible Lever Ratchet 1/4" | 3/8" | 1/2" (13 | 19 | 22 mm)
- Extension Bar 1/4" | 3/8" | 1/2" (13 | 19 | 22 mm), length 75 mm
- Adaptor to 1/4" | 3/8" | 1/2"
- Quick-release Square Adaptor to 1/4" | 3/8" | 1/2"
- Go-Through Sockets 1/4" (13 mm) 4,5 | 5 | 5,5 | 6 | 7 | 8 | 9 | 10 | 11 mm
- Go-Through Sockets 3/8" (19 mm) 10 | 11 | 12 | 13 | 14 | 15 | 16 | 17 | 18 | 19 mm
- Go-Through Sockets 1/2" (22 mm) 19 | 20 | 21 | 22 | 23 | 24 mm
- 1/4" PH Screwdriver Socket PH1 | PH2
- 1/4" TX Screwdriver Socket TX10 | TX15
- 1/4" Screwdriver Socket 3 | 4 | 6 mm
- 1/4" Inside Hexagon Screwdriver Socket 4 | 5 | 6 mm

Art.-No.	Für For	L x B x H (mm) L x W x H (mm)		
6510000	140 142 146 145 3991 3993	342 x 268 x 38	2960	1



6230

MODUL KRAFT-EINSÄTZE, LANGE AUSFÜHRUNG MODULE IMPACT SOCKETS, LONG

Chrom-Molybdän Stahl
schwarz
15-tlg.

1/2" Kraft-Einsatz, 6-kant, lange Ausführung 10 | 12 | 13 | 14 | 15 | 16 |
17 | 19 | 21 | 22 | 24 | 27 mm
1/2" Kraft-Verlängerung 125 mm
1/2" Kraft-Kardan-Gelenk
3/8" Kraft-Übergangsteil, 3/8" innen, 1/2" außen



Chrome-Molybdenum steel
black
15 pcs.

1/2" Impact Socket, 6-point, long type 10 | 12 | 13 | 14 | 15 | 16 |
17 | 19 | 21 | 22 | 24 | 27 mm
1/2" Impact Extension Bar 125 mm
1/2" Impact Universal Joint
3/8" Impact Adaptor, 3/8" female, 1/2" male

Art.-No.	Für For	L x B x H (mm) L x W x H (mm)		
6230000	140 142 143 145 3991 3993	342 x 268 x 38	3193	1

Einzelteile entsprechen der DIN | parts according to DIN



6040

MODUL ZANGEN MODULE PLIERS

Kopf poliert
2-Komponentengriffe
5-tlg.

Kombinationszange 180 mm
Kraftseitenschneider 180 mm
Flachrundzange, gerade 200 mm
Wasserpumpenzange 250 mm
Seitenschneider 145 mm

head polished
two component handle
5 pcs.

Combination Pliers 180 mm
Heavy Duty Diagonal Cutters 180 mm
Snipe Nose Pliers, straight 200 mm
Water Pump Pliers 250 mm
Diagonal Cutters 145 mm

Art.-No.	Für For	L x B x H (mm) L x W x H (mm)		
6040000	140 142 143 145 3991 3993	342 x 268 x 38	1889	1

Einzelteile entsprechen der DIN | parts according to DIN

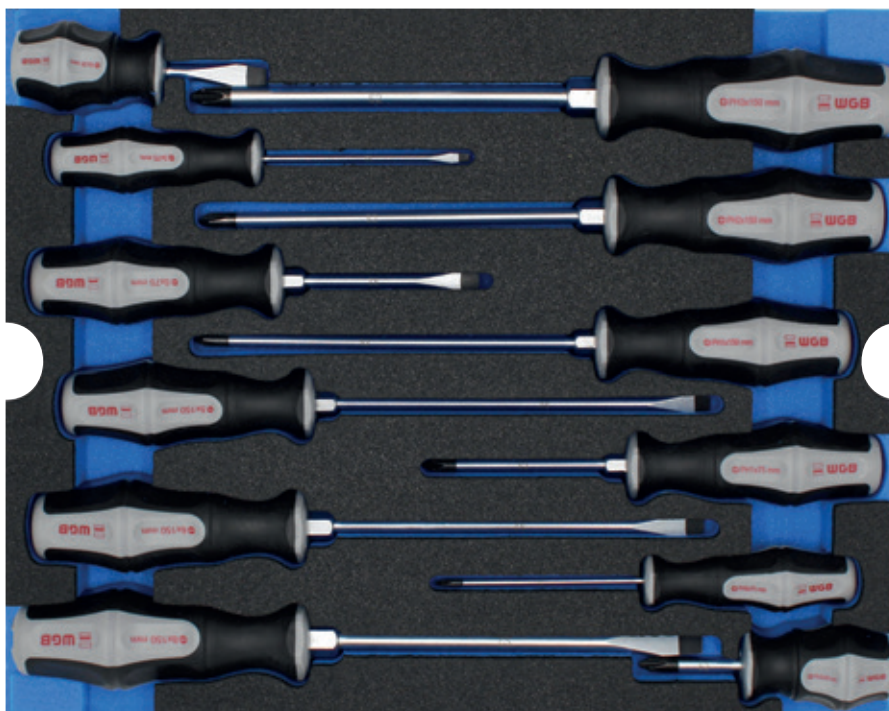

6240

MODUL SCHRAUBENDREHER MODULE SCREWDRIVER



S2-Profi-Stahl
verchromt
2-Komponentenheft
durchgehende Klinge
mit Sechskantansatz
mit Schlagkappe
12-tlg.

Werkstatt-Schraubendreher 3 x 75 | 5 x 75 | 5 x 150 | 6 x 150 | 8 x 150 mm
Vergaser-Schraubendreher 6 mm
PH Schraubendreher PH0 x 75 | PH1 x 75 | PH1 x 150 | PH2 x 150 | PH3 x 150 mm
PH Vergaser-Werkstatt-Schraubendreher PH2



S2 Professional steel
chrome plated
two component handle
protruding blade
with hexagon bolster
with hammer cap
12 pcs.

Engineers Screwdriver 3 x 75 | 5 x 75 | 5 x 150 | 6 x 150 | 8 x 150 mm
Stubby Engineers Screwdriver 6 mm
PH Screwdriver PH0 x 75 | PH1 x 75 | PH1 x 150 | PH2 x 150 | PH3 x 150 mm
PH Stubby Screwdriver PH2

Art.-No.	Für For	L x B x H (mm) L x W x H (mm)		
6240000	140 142 143 145 3991 3993	342 x 268 x 38	1382	1

Einzelteile entsprechen der DIN | parts according to DIN



6500

MODUL HAUSMEISTER-SET UNIVERSAL MODULE JANITOR SET UNIVERSAL

14-tlg.

- Schlosser-Hammer 500 g
- Sicherheits-Stiftschlüssel-Satz 1,5 | 2 | 2,5 | 3 | 4 | 5 | 6 | 8 | 10 mm
- Kombinationszange 180 mm
- Wasserpumpenzange 250 mm
- Taschenrollbandmaß 3 m
- Profi-Sicherheits-Messer

14 pcs.

- Machinist's Hammer 500 g
- Safety Hexagon Key Wrench Set 1.5 | 2 | 2.5 | 3 | 4 | 5 | 6 | 8 | 10 mm
- Combination Pliers 180 mm
- Water Pump Pliers 250 mm
- Pocket Measuring Tape 3 m
- Professional Safety Knife

Art.-No.	Für For	L x B x H (mm) L x W x H (mm)		
6500000	140 142 145 145 3991 3993	342 x 268 x 38	2360	1

Einzelteile entsprechen der DIN | parts according to DIN



6290

MODUL HAMMER, MEISSEL, DURCHTREIBER MODULE HAMMER, CHISELS AND PUNCHES

Chrom-Vanadium Stahl
Spezialstahl
Chrom-Vanadium-Lufthärtestahl
14-tlg.

Schlosser-Hammer 500 g
Kunststoffhammer 32 mm
Flachmeißel 125 | 150 | 200 mm
Körner 4 | 5 | 6 mm
Splintentreiber 2 | 3 | 4 | 5 | 6 | 8 mm

Chrome-Vanadium steel
Special steel
Chrome-Vanadium air-hardened steel
14 pcs.

Machinist's Hammer 500 g
Plastic Faced Hammer 32 mm
Flat Chisel 125 | 150 | 200 mm
Centre Punch 4 | 5 | 6 mm
Parallel Pin Punch 2 | 3 | 4 | 5 | 6 | 8 mm

Art.-No.	Für For	L x B x H (mm) L x W x H (mm)		
6290000	140 142 143 145 3991 3993	342 x 268 x 38	2549	1

Einzelteile entsprechen der DIN | parts according to DIN

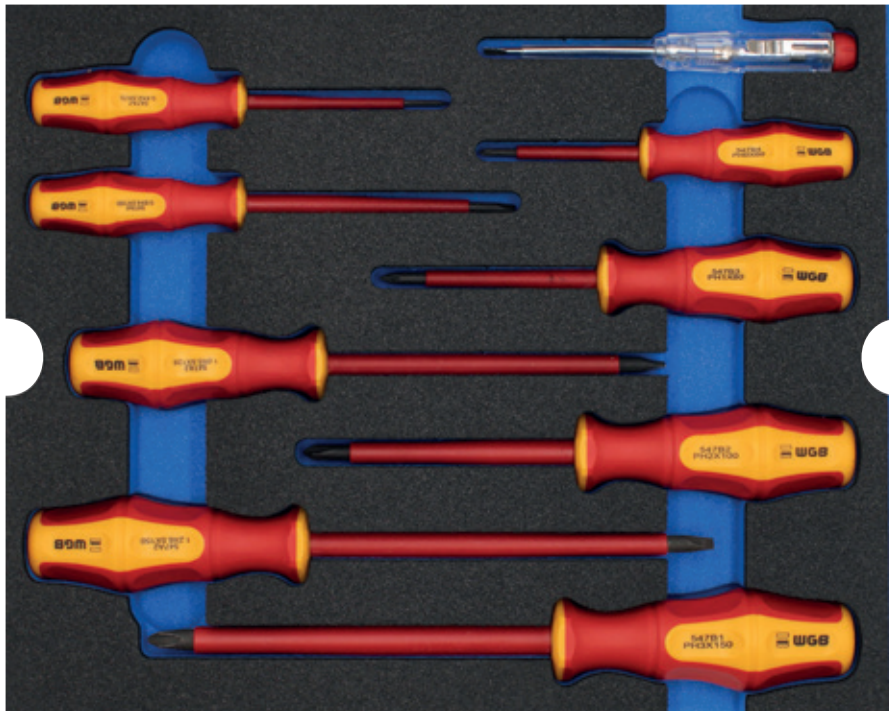

6110

MODUL VDE SCHRAUBENDREHER MODULE VDE SCREWDRIVER

isoliert nach DIN EN 60900 (VDE 0682/201)
S2-Profi-Stahl
2-Komponentenheft
Klinge mit magnetischer Spitze
9-tlg.

VDE Werkstattschraubendreher 2,5 x 75 | 4 x 100 | 6,5 x 150 mm
VDE PH Schraubendreher PH0 x 60 | PH1 x 80 | PH2 x 100 | PH3 x 150 mm
Spannungsprüfer 3,0 x 65 mm



isolated according to DIN EN 60900 (VDE 0682/201)
S2 Professional steel
two component handle
blade with magnetic tip
9 pcs.

VDE Engineers Screwdriver 2,5 x 75 | 4 x 100 | 6,5 x 150 mm
VDE PH Screwdriver PH0 x 60 | PH1 x 80 | PH2 x 100 | PH3 x 150 mm
Voltage tester 3,0 x 65 mm

Art.-No.	Für For	L x B x H (mm) L x W x H (mm)		
6110000	140 142 143 145 3991 3993	342 x 268 x 38	1046	1

Einzelteile entsprechen der DIN | parts according to DIN

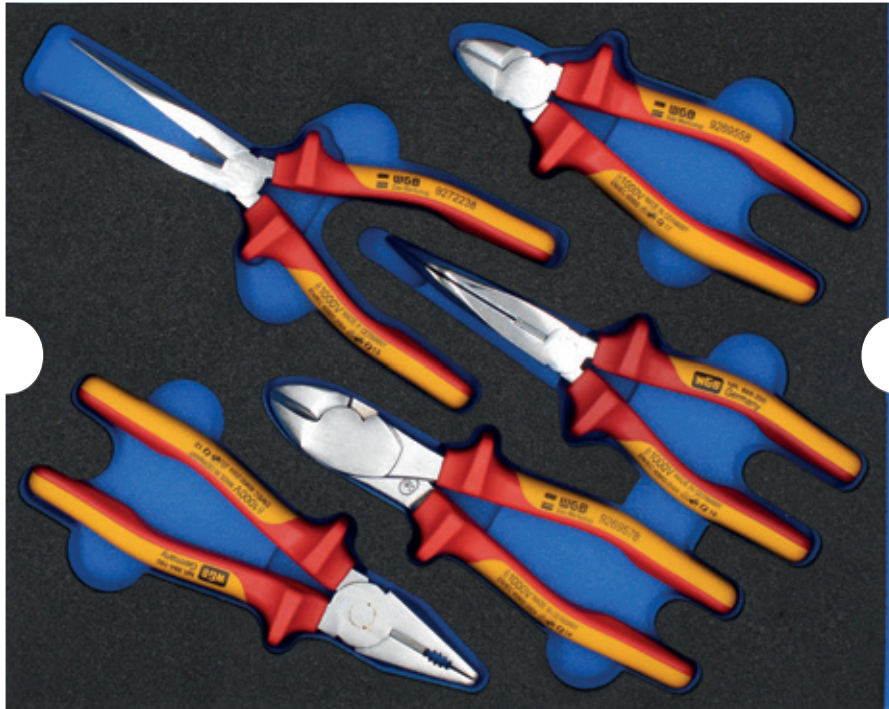

6300

MODUL VDE ZANGEN MODULE VDE PLIERS

isoliert nach DIN EN 60900 (VDE 0682/201)
verchromt
Kopf hochglanz poliert
2-Komponentengriffe
5-tlg.

VDE Kombinationszange 180 mm
VDE Kraftseitenschneider 180 mm
VDE Seitenschneider 160 mm
VDE Flachrundzange, gerade 200 mm
VDE Flachrundzange, 45° abgewinkelt 200 mm



isolated according to DIN EN 60900 (VDE 0682/201)
chrome plated
head mirror polished
two component handle
5 pcs.

VDE Combination Pliers 180 mm
VDE Heavy Duty Diagonal Cutters 180 mm
VDE Diagonal Cutters 160 mm
VDE Snipe Nose Pliers, straight 200 mm
VDE Snipe Nose Pliers, 45° bent 200 mm

Art.-No.	Für For	L x B x H (mm) L x W x H (mm)		
6300000	140 142 143 145 3991 3993	342 x 268 x 38	1308	1

Einzelteile entsprechen der DIN | parts according to DIN



3991

SYSTAINER® CLASSIC LINE
SYSTAINER® CLASSIC LINE

original TANOS-systainer® Classic Line
zur Aufbewahrung von Werkzeugen und Maschinen
Kunststoff, schlagfest (ABS)
stapelbar
mit Griff
1 großes Fach

original TANOS systainer® Classic Line
for storage of hand tools and machines
plastic, impact-proof (ABS)
stackable
with handle
1 big case

Art.-No.	L x B x H (mm) L x W x H (mm)	 g	
9301600	395 x 295 x 105	1250	1



3993

L-BOXX® INDUSTRIAL LINE
L-BOXX® INDUSTRIAL LINE

original L-BOXX®
zur Aufbewahrung von Werkzeugen und Maschinen
Kunststoff, schlagfest (ABS)
stapelbar
mit Griff
1 großes Fach

original L-BOXX®
for storage of hand tools and machines
plastic, impact-proof (ABS)
stackable
with handle
1 big case

Art.-No.	L x B x H (mm) L x W x H (mm)	 g	
9303750	445 x 355 x 120	2109	1



165

ROLLTASCHE BESTÜCKT ROLL POUCH, EQUIPPED

17-tlg.

Schlosser-Hammer 400 g
PH Schraubendreher PH1 | PH2
Sechskant-Stiftschlüssel-Satz mit Kugelkopf, 9-tlg. 1,5 | 2 | 2,5 | 3 | 4 | 5 | 6 | 8 | 10 mm
Kombinationszange 200 mm
Werkstattschraubendreher 4,5 | 5,5 | 7 | 9 mm

17 pcs.

Machinist's Hammer 400 g
PH Screwdriver PH1 | PH2
Hexagon Key Wrench Set with ballpoint, 9 tlg. 1.5 | 2 | 2.5 | 3 | 4 | 5 | 6 | 8 | 10 mm
Combination Pliers 200 mm
Engineers Screwdriver 4,5 | 5,5 | 7 | 9 mm

Art.-No.	L x B x H (mm) L x W x H (mm)	 g	
9010530	800 x 320 x 25	1950	1



164

PROFI-WERKZEUGRUCKSACK PROFESSIONAL TOOL BACKPACK

schwarz-grau, bestückt mit WGB-Logo
sehr großer Stauraum, ideal zum Unterbringen von Werkzeugen
hoch belastbares, wasserabweisendes Polyestergewebe
gepolstertes Rückenteil und Schulterträger mit Handyfach
ummantelter Handtragegriff für angenehmen Tragekomfort
grobgerasterter Reißverschluss, schmutzunempfindlich
3-teilige Innenfächer, ausklappbar
4 Außenfächer zur praktischen Werkzeugaufnahme



black-grey, with WGB-Logo
large capacities, ideal for storage of tools
heavy-duty, water repellent polyester fabric
padded back section and shoulder strap with mobile phone pocket
upholstered handle for comfortable carrying comfort
strong zippers, dirt resistant
3-part internal compartments, fold out
4 external Pockets for practical tool storage

Art.-No.	L x B x H (mm) L x W x H (mm)	 g	
9287600	400 x 360 x 230	2600	1

164 U

PROFI-WERKZEUGRUCKSACK UNIVERSAL PROFESSIONAL TOOL BACKPACK UNIVERSAL

35-tlg.

Schlosser-Hammer 400 g
 Kraftseitenschneider 180 mm
 Zollstock 2 m
 Zimmermannsbleistift oval
 Ringmaulschlüssel-Satz, 8-tlg. 8 | 9 | 10 | 11 | 13 | 14 | 17 | 19 mm
 Wasserwaage 400 mm
 Profil-Reifenheber 400 mm
 Eckrohrzange 45° abgewinkelt, S-Maul 1.1/2"
 Wasserpumpenzange 240 mm
 Universal Grip-Zange 250 mm
 Flachrundzange 200 mm
 Kombinationszange 200 mm
 Werkstattschraubendreher 4,5 | 5,5 | 7 | 9 mm
 PH Schraubendreher PH1 | PH2
 Sechskant-Stiftschlüssel-Satz, 9-tlg. 1,5 | 2 | 2,5 | 3 | 4 | 5 | 6 | 8 | 10 mm
 Stahl-Drahtbürste, 4 Reihen 295 mm

35 pcs.

Machinist's Hammer 400 g
 Heavy-Duty Diagonal Cutters 180 mm
 Folding Rule 2 m
 Carpenter's Pencil, oval
 Combination Spanner Set, 8 pcs. 8 | 9 | 10 | 11 | 13 | 14 | 17 | 19 mm
 Water Level 400 mm
 Tyre Lever 400 mm
 Pipe Wrench angled 45°, S-jaw 1.1/2"
 Water Pump Pliers 240 mm
 Grip Pliers 250 mm
 Snipe Nose Pliers 200 mm
 Combination Pliers 200 mm
 Engineers Screwdriver 4,5 | 5,5 | 7 | 9 mm
 PH Screwdriver PH1 | PH2
 Hexagon Key Wrench Set, 9 pcs. 1,5 | 2 | 2,5 | 3 | 4 | 5 | 6 | 8 | 10 mm
 Steel Wire Brush, 4 rows 295 mm



Art.-No.	L x B x H (mm) L x W x H (mm)	 g	
9010504	400 x 360 x 230	8300	1

164 V

PROFI-WERKZEUGRUCKSACK VDE PROFESSIONAL TOOL BACKPACK VDE



35-tlg.

Schlosser-Hammer 400 g
 VDE Schraubendreher 3,5 | 5,5 | 6,5 mm
 Zollstock 2 m
 Zimmermannsbleistift oval
 Ringmaulschlüssel-Satz, 8-tlg. 8 | 9 | 10 | 11 | 13 | 14 | 17 | 19 mm
 Wasserwaage 400 mm
 VDE Abisolierzange 160 mm
 VDE PH Schraubendreher PH1 | PH2
 VDE Kombinationszange 180 mm
 VDE Flachrundzange, gerade 200 mm
 VDE Kraftseitenschneider 200 mm
 Kabelschere 170 mm
 Kabelmesser 165 mm
 Wasserpumpenzange 240 mm
 Sechskant-Stiftschlüssel-Satz, 9-tlg. 1,5 | 2 | 2,5 | 3 | 4 | 5 | 6 | 8 | 10 mm
 VDE Spannungsprüfer 120-250 Volt

35 pcs.

Machinist's Hammer 400 g
 VDE Screwdriver 3,5 | 5,5 | 6,5 mm
 Folding Rule 2 m
 Carpenter's Pencil, oval
 Combination Spanner Set, 8 pcs. 8 | 9 | 10 | 11 | 13 | 14 | 17 | 19 mm
 Water Level 400 mm
 VDE Wire Stripper 160 mm
 VDE PH Screwdriver PH1 | PH2
 VDE Combination Pliers 180 mm
 VDE Snipe Nose Pliers, straight 200 mm
 VDE Heavy Duty Diagonal Cutters 200 mm
 Cable Cutters 170 mm
 Cable Knife 165 mm
 Water Pump Pliers 240 mm
 Hexagon Key Wrench Set, 9 pcs. 1,5 | 2 | 2,5 | 3 | 4 | 5 | 6 | 8 | 10 mm
 VDE Voltage Tester 120-250 Volt



Art.-No.	L x B x H (mm) L x W x H (mm)	 g	
9010503	400 x 360 x 230	6277	1



163

PROFI-WERKZEUGTASCHE PROFESSIONAL TOOL BAG

schwarz-grau, bestickt mit WGB-Logo
sehr großer Stauraum, ideal zum Unterbringen von Werkzeugen
verstärkter Boden
stabiler, abklappbarer Stahlrohr-Tragebügel
verstellbarer, abnehmbarer Tragegurt
Einsteckschlaufen für verschiedene Werkzeuge
abnehmbare Klettverschlussabdeckung
Kette für Klebeband, Malerkrepp etc.
Halterung für Rollmaßband

black-grey, with WGB-Logo
large capacity, ideal for storage of tools
reinforced bottom
solid, foldaway steel tube carrying bar
adjustable, removable shoulder strap
multiple external pockets for tools
removable velcro fastener cover
chain for adhesive tape, masking tape etc.
holder for measuring tape

Art.-No.	L x B x H (mm) L x W x H (mm)	 g	
9287590	255 x 410 x 200	1850	1

163 U

PROFI-WERKZEUGTASCHE UNIVERSAL PROFESSIONAL TOOL BAG UNIVERSAL

35-tlg.

Schlosser-Hammer 400 g
Kraftseitenschneider 180 mm
Zollstock 2 m
Zimmermannsbleistift oval
Ringmaulschlüssel-Satz, 8-tlg. 8 | 9 | 10 | 11 | 13 | 14 | 17 | 19 mm
Wasserwaage 400 mm
Profil-Reifenheber 400 mm
Eckrohrzange 45° abgewinkelt, S-Maul 1.1/2"
Wasserpumpenzange 240 mm
Universal Grip-Zange 250 mm
Flachrundzange, gerade 200 mm
Kombinationszange 200 mm
Werkstattsschraubendreher 4,5 | 5,5 | 7 | 9 mm
PH Schraubendreher PH1 | PH2
Sechskant-Stiftschlüssel-Satz, 9-tlg. 1,5 | 2 | 2,5 | 3 | 4 | 5 | 6 | 8 | 10 mm
Stahl-Drahtbürste, 4 Reihen 295 mm

35 pcs.

Machinist's Hammer 400 g
Heavy-Duty Diagonal Cutters 180 mm
Folding Rule 2 m
Carpenter's Pencil, oval
Combination Spanner Set, 8 pcs. 8 | 9 | 10 | 11 | 13 | 14 | 17 | 19 mm
Water Level 400 mm
Tyre Lever 400 mm
Pipe Wrench angled 45°, S-jaw 1.1/2"
Water Pump Pliers 240 mm
Grip Pliers 250 mm
Snipe Nose Pliers, straight 200 mm
Combination Pliers 200 mm
Engineers Screwdriver 4,5 | 5,5 | 7 | 9 mm
PH Screwdriver PH1 | PH2
Hexagon Key Wrench Set, 9 pcs. 1,5 | 2 | 2,5 | 3 | 4 | 5 | 6 | 8 | 10 mm
Steel Wire Brush, 4 rows 295 mm



Art.-No.	L x B x H (mm) L x W x H (mm)	 g	
9010505	255 x 410 x 200	7550	1

163 V

PROFI-WERKZEUGTASCHE VDE PROFESSIONAL TOOL BAG VDE

35-tlg.

Schlosser-Hammer 400 g
VDE Schraubendreher 3,5 | 5,5 | 6,5 mm
Zollstock 2 m
Zimmermannsbleistift oval
Ringmaulschlüssel-Satz, 8-tlg. 8 | 9 | 10 | 11 | 13 | 14 | 17 | 19 mm
Wasserwaage 400 mm
VDE Abisolierzange 160 mm
VDE PH Schraubendreher PH1 | PH2
VDE Kombinationszange 180 mm
VDE Flachrundzange, gerade 200 mm
VDE Kraftseitenschneider 200 mm
Kabelschere 170 mm
Kabelmesser 165 mm
Wasserpumpenzange 240 mm
Sechskant-Stiftschlüssel-Satz, 9-tlg. 1,5 | 2 | 2,5 | 3 | 4 | 5 | 6 | 8 | 10 mm
VDE Spannungsprüfer 120-250 Volt

35 pcs.

Machinist's Hammer 400 g
VDE Screwdriver 3,5 | 5,5 | 6,5 mm
Folding Rule 2 m
Carpenter's Pencil, oval
Combination Spanner Set, 8 pcs. 8 | 9 | 10 | 11 | 13 | 14 | 17 | 19 mm
Water Level 400 mm
VDE Wire Stripper 160 mm
VDE PH Screwdriver PH1 | PH2
VDE Combination Pliers 180 mm
VDE Snipe Nose Pliers, straight 200 mm
VDE Heavy Duty Diagonal Cutters 200 mm
Cable Cutters 170 mm
Cable Knife 165 mm
Water Pump Pliers 240 mm
Hexagon Key Wrench Set, 9 pcs. 1,5 | 2 | 2,5 | 3 | 4 | 5 | 6 | 8 | 10 mm
VDE Voltage Tester 120-250 Volt



Art.-No.	L x B x H (mm) L x W x H (mm)	 g	
9010502	255 x 410 x 200	5527	1



108

WERKZEUGKASTEN BESTÜCKT TOOL BOX, EQUIPPED

56-tlg.

Doppelmaulschlüssel 6 x 7 | 8 x 9 | 10 x 11 | 12 x 13 | 14 x 15 | 16 x 17 | 18 x 19 | 20 x 22 mm
 Doppelringschlüssel 6 x 7 | 8 x 9 | 10 x 11 | 12 x 13 | 14 x 15 | 16 x 17 | 18 x 19 | 20 x 22 mm
 1/2" Steckschlüssel-Einsatz, 6-kant 10 | 11 | 12 | 13 | 14 | 15 | 17 | 19 | 22 | 24 | 27 | 30 | 32 mm
 Sechskant-Stiftschlüssel-Satz 2,5 | 3 | 4 | 5 | 6 | 8 mm
 1/2" Kardan-Gelenk 73 mm
 1/2" Griff mit Gleitstück 300 mm
 1/2" Verlängerung 125 | 250 mm
 1/2" Umschaltknarre, 45 Zähne 250 mm
 Profil-Reifenheber 400 mm
 1/2" Zündkerzen-Einsatz 21 mm
 Werkstatt-Schraubendreher 4 | 6 | 8 mm
 PH Schraubendreher PH2
 VDE Spannungsprüfer 120-250 Volt
 Schlosser-Hammer 500 g
 Körner 120 x 2 mm
 Flachmeißel 150 mm
 Durchtreiber 120 x 4 mm
 Kombinationszange 180 mm
 Seitenschneider 160 mm
 Wasserpumpenzange 240 mm
 Universal-Grip-Zange 250 mm

56 pcs.

Double Open Ended Spanner 6 x 7 | 8 x 9 | 10 x 11 | 12 x 13 | 14 x 15 | 16 x 17 | 18 x 19 | 20 x 22 mm
 Double Ended Ring Spanner 6 x 7 | 8 x 9 | 10 x 11 | 12 x 13 | 14 x 15 | 16 x 17 | 18 x 19 | 20 x 22 mm
 1/2" Socket, 6-point 10 | 11 | 12 | 13 | 14 | 15 | 17 | 19 | 22 | 24 | 27 | 30 | 32 mm
 Hexagon Key Wrench Set 2,5 | 3 | 4 | 5 | 6 | 8 mm
 1/2" Universal Joint 73 mm
 1/2" Sliding T-Handle 300 mm
 1/2" Extension Bar 125 | 250 mm
 1/2" Reversible Ratchet, 45 teeth 250 mm
 Tyre Lever 400 mm
 1/2" Spark Plug Socket 21 mm
 Engineers Screwdriver 4 | 6 | 8 mm
 PH Screwdriver PH2
 VDE Voltage Tester 120-250 Volt
 Machinist's Hammer 500 g
 Centre Punch 120 x 2 mm
 Flat Chisel 150 mm
 Section Punch 120 x 4 mm
 Combination Pliers 180 mm
 Diagonal Cutters 160 mm
 Water Pump Pliers 240 mm
 Grip Pliers 250 mm

Art.-No.

9000090

L x B x H (mm)
L x W x H (mm)

200 x 530 x 200



16500



1



103

WERKZEUGKASTEN
TOOL BOX

Stahlblech
lackiert
3 Fächer

sheet steel
lacquered
3 compartments

Art.-No.	L x B x H (mm) L x W x H (mm)	 g	
9200280	200 x 430 x 150	3500	1



105

WERKZEUGKASTEN
TOOL BOX

Stahlblech
lackiert
5 Fächer

sheet steel
lacquered
5 compartments

Art.-No.	L x B x H (mm) L x W x H (mm)	 g	
9200290	200 x 530 x 200	4860	1





SCHRAUBENSCHLÜSSEL
SPANNERS

02



690

DOPPELMAULSCHLÜSSEL, DIN 3110 DOUBLE OPEN ENDED SPANNER, DIN 3110

ISO 1085, ISO 3318, ISO 10102
Chrom-Vanadium Stahl
verchromt

ISO 1085, ISO 3318, ISO 10102
Chrome-Vanadium steel
chrome plated

Art.-No.	Ø mm	l mm	g	Box
6904553	4,5 x 5,5	125	21	10
6905573	5,5 x 7	123	16	10
6906073	6 x 7	123	18	10
6907083	7 x 8	131	24	10
6907093	7 x 9	142	34	10
6908093	8 x 9	142	29	10
6908103	8 x 10	142	34	10
6909103	9 x 10	159	48	10
6909113	9 x 11	159	50	10
6910113	10 x 11	159	51	10
6910123	10 x 12	159	55	10
6910133	10 x 13	171	66	10
6911133	11 x 13	171	70	10
6911143	11 x 14	171	73	10
6912133	12 x 13	171	70	10
6912143	12 x 14	175	74	10
6913143	13 x 14	175	76	10
6913153	13 x 15	186	88	10
6913173	13 x 17	200	98	10
6914153	14 x 15	186	92	10
6914173	14 x 17	200	120	10
6916173	16 x 17	200	132	10
6916183	16 x 18	200	134	10
6917193	17 x 19	219	145	10

Art.-No.	Ø mm	l mm	g	Box
6918193	18 x 19	219	155	10
6918213	18 x 21	235	200	10
6919223	19 x 22	237	220	10
6919243	19 x 24	240	234	10
6920223	20 x 22	237	220	10
6921233	21 x 23	247	226	10
6921243	21 x 24	247	210	10
6922243	22 x 24	247	253	10
6922273	22 x 27	264	265	10
6924263	24 x 26	264	340	10
6924273	24 x 27	264	345	10
6924303	24 x 30	278	425	10
6925283	25 x 28	278	352	10
6927303	27 x 30	299	454	10
6927323	27 x 32	299	460	10
6930323	30 x 32	299	540	10
6930343	30 x 34	299	480	10
6930363	30 x 36	308	506	10
6932363	32 x 36	308	596	10
6934363	34 x 36	328	740	10
6936413	36 x 41	353	880	5
6941463	41 x 46	419	1300	1
6946503	46 x 50	475	1674	1
6955603	55 x 60	540	3100	1

690 S

DOPPELMAULSCHLÜSSEL-SATZ, DIN 3110 DOUBLE OPEN ENDED SPANNER SET, DIN 3110

DIN ISO 1085, ISO 3318, ISO 10102
Chrom-Vanadium Stahl | verchromt | im Sichtkarton

DIN ISO 1085, ISO 3318, ISO 10102
Chrome-Vanadium steel | chrome plated | in display cardboard box



Art.-No.	No.	Ø mm	g	Box
9001573	690S/8	6 x 7 8 x 9 10 x 11 12 x 13 14 x 15 16 x 17 18 x 19 20 x 22	764	1

Für alternative Satzbestückung sprechen Sie uns bitte an. | Please ask us for customized set contents.



690 K

DOPPELMAULSCHLÜSSEL-SATZ, DIN 3110
DOUBLE OPEN ENDED SPANNER SET, DIN 3110

DIN ISO 1085, ISO 3318, ISO 10102
Chrom-Vanadium Stahl
verchromt
im Karton

DIN ISO 1085, ISO 3318, ISO 10102
Chrome-Vanadium steel
chrome plated
in cardboard box

Art.-No.	No.	Ø _{mm}	g	☐
6900013	690K/6	6 x 7 8 x 9 10 x 11 12 x 13 14 x 15 16 x 17	377	1
6900423	690K/06	6 x 7 8 x 9 10 x 11 12 x 13 14 x 17 19 x 22	570	1
6900023	690K/8	6 x 7 8 x 9 10 x 11 12 x 13 14 x 15 16 x 17 18 x 19 20 x 22	820	1
6900043	690K/010	6 x 7 8 x 9 10 x 11 12 x 13 14 x 15 16 x 17 18 x 19 20 x 22 21 x 23 24 x 27	1410	1
6900053	690K/10	6 x 7 8 x 9 10 x 11 12 x 13 14 x 15 16 x 17 18 x 19 20 x 22 24 x 27 30 x 32	1424	1
6900033	690K/12	6 x 7 8 x 9 10 x 11 12 x 13 14 x 15 16 x 17 18 x 19 20 x 22 21 x 23 24 x 27 25 x 28 30 x 32	2320	1



690 RT

DOPPELMAULSCHLÜSSEL-SATZ, DIN 3110
DOUBLE OPEN ENDED SPANNER SET, DIN 3110

DIN ISO 1085, ISO 3318, ISO 10102
Chrom-Vanadium Stahl
verchromt
in Rolltasche

DIN ISO 1085, ISO 3318, ISO 10102
Chrome-Vanadium steel
chrome plated
in roll pouch

Art.-No.	No.	Ø _{mm}	g	☐
9001493	690RT/6	6 x 7 8 x 9 10 x 11 12 x 13 14 x 15 16 x 17	877	1
9001503	690RT/8	6 x 7 8 x 9 10 x 11 12 x 13 14 x 15 16 x 17 18 x 19 20 x 22	1259	1
6900113	690RT/08	6 x 7 8 x 9 10 x 11 12 x 13 14 x 15 16 x 17 18 x 19 22 x 24	763	1
9001513	690RT/12	6 x 7 8 x 9 10 x 11 12 x 13 14 x 15 16 x 17 18 x 19 20 x 22 21 x 23 24 x 27 25 x 28 30 x 32	2601	1



230

RINGMAULSCHLÜSSEL, RINGSEITE 15° ABGEWINKELT, DIN 3113 A COMBINATION SPANNER, RING 15° OFFSET, DIN 3113 A

ISO 3318, ISO 7738
Chrom-Vanadium Stahl
verchromt

ISO 3318, ISO 7738
Chrome-Vanadium steel
chrome plated

Art.-No.	mm	mm-l	g	
2300603	6	103	18	10
2300703	7	112	22	10
2300803	8	124	27	10
2300903	9	133	32	10
2301003	10	141	45	10
2301103	11	155	50	10
2301203	12	160	57	10
2301303	13	174	76	10
2301403	14	182	90	10
2301503	15	192	98	10
2301603	16	205	115	10
2301703	17	210	132	10
2301803	18	218	150	10
2301903	19	229	170	10
2302003	20	238	177	10
2302103	21	248	215	10
2302203	22	259	248	10
2302403	24	290	312	5
2302503	25	300	412	5
2302603	26	309	435	5
2302703	27	310	435	5
2302803	28	320	489	5
2302903	29	320	489	5
2303003	30	329	490	5
2303203	32	364	590	5
2303403	34	369	612	5
2303603	36	385	800	5
2304103	41	440	1100	1
2304603	46	492	1730	1



230/1

RINGMAULSCHLÜSSEL, RINGSEITE 15° ABGEWINKELT, DIN 3113 A
COMBINATION SPANNER, RING 15° OFFSET, DIN 3113 A

ISO 3318, ISO 7738
Chrom-Vanadium Stahl
verchromt

ISO 3318, ISO 7738
Chrome-Vanadium steel
chrome plated

Art.-No.	AF"	l-mm-l	g	
2314003	1/4"	100	17	10
2303873	5/16"	120	26	10
23000383	3/8"	140	37	10
23007163	7/16"	151	58	10
2312003	1/2"	170	66	10
23009163	9/16"	182	82	10
23000583	5/8"	201	114	10
23011163	11/16"	211	137	10
23000343	3/4"	233	189	10
23013163	13/16"	250	215	10
23000783	7/8"	260	226	10
23015163	15/16"	270	250	5
23000013	1"	290	313	5
23001183	1 1/8"	275	400	5
23131603	1.3/16"	325	492	5
23001143	1 1/4"	345	600	5
23151603	1.5/16"	383	764	5

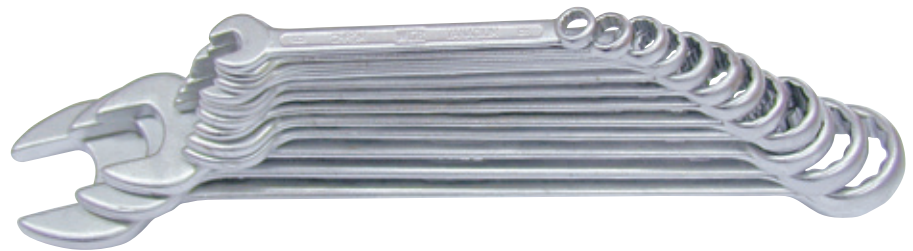

230/1 KSB

RINGMAULSCHLÜSSEL-SATZ, RINGSEITE 15° ABGEWINKELT, DIN 3113 A
COMBINATION SPANNER SET, RING 15° OFFSET, DIN 3113 A

ISO 3318, ISO 7738
Chrom-Vanadium Stahl
verchromt
in Kunststoffschiebox

ISO 3318, ISO 7738
Chrome-Vanadium steel
chrome plated
in plastic sliding box

Art.-No.	AF"	g	
2300173	1/4" 5/16" 3/8" 7/16" 1/2" 9/16" 5/8" 11/16" 3/4" 13/16" 7/8" 1"	1507	1

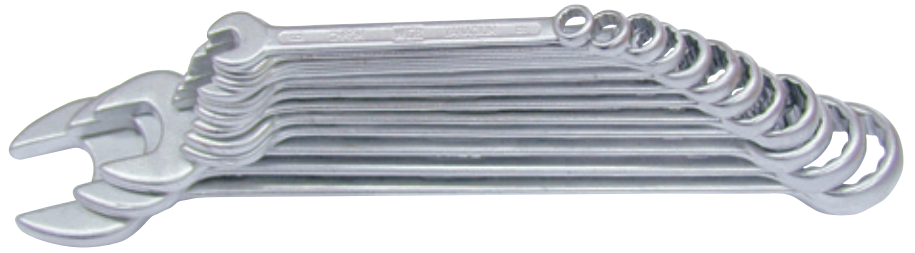

230 K

RINGMAULSCHLÜSSEL-SATZ, RINGSEITE 15° ABGEWINKELT, DIN 3113 A
COMBINATION SPANNER SET, RING 15° OFFSET, DIN 3113 A

ISO 3318, ISO 7738
Chrom-Vanadium Stahl
verchromt
im Karton

ISO 3318, ISO 7738
Chrome-Vanadium steel
chrome plated
in cardboard box

Art.-No.	No.	mm	g	
2300013	230K/8	8 9 10 11 13 14 17 19	578	1
2300023	230K/9	10 11 12 13 14 15 17 19 22	951	1
2300033	230K/10	8 10 11 12 13 14 15 17 19 22	972	1
2300043	230K/121	6 7 8 9 10 11 12 13 14 15 17 19	766	1
2300053	230K/12	6 7 8 9 10 11 12 13 14 17 19 22	930	1
2300213	230K/012	10 11 12 13 14 17 19 22 24 27 30 32	2650	1



230 RT

RINGMAULSCHLÜSSEL-SATZ, RINGSEITE 15° ABGEWINKELT, DIN 3113 A
COMBINATION SPANNER SET, RING 15° OFFSET, DIN 3113 A

ISO 3318, ISO 7738
Chrom-Vanadium Stahl
verchromt
in Rolltasche

ISO 3318, ISO 7738
Chrome-Vanadium steel
chrome plated
in roll pouch

Art.-No.	No.	mm	g	
9002763	230RT/8	8 9 10 11 13 14 17 19	1144	1
2300293	230RT/08	7 8 10 13 15 17 19 24	923	1
9002773	230RT/12	6 7 8 9 10 11 12 13 14 17 19 22	1465	1
2300283	230RT/012	10 11 12 13 14 17 19 22 24 27 30 32	2609	1



230 PT

RINGMAULSCHLÜSSEL-SATZ, RINGSEITE 15° ABGEWINKELT, DIN 3113 A
COMBINATION SPANNER SET, RING 15° OFFSET, DIN 3113 A

ISO 3318, ISO 7738
Chrom-Vanadium-Stahl
verchromt
in 2 Plastiktaschen

ISO 3318, ISO 7738
Chrome Vanadium steel
chrome plated
in 2 plastic wallets

Art.-No.	No.	mm		
9006893	230PT/20	6 7 8 9 10 11 12 13 14 15 16 17 18 19 21 22 24 27 30 32	3000	1



230 S

**RINGMAULSCHLÜSSEL-SATZ,
RINGSEITE 15° ABGEWINKELT, DIN 3113 A**
COMBINATION SPANNER SET,
RING 15° OFFSET, DIN 3113 A

ISO 3318, ISO 7738
Chrom-Vanadium Stahl
verchromt
im Sichtkarton

ISO 3318, ISO 7738
Chrome-Vanadium steel
chrome plated
in display cardboard box

Art.-No.	No.	mm		
9002703	230S/8	8 9 10 11 13 14 17 19	696	1

Für alternative Satzbestückung sprechen Sie uns bitte an. | Please ask us for customized set contents.

DIE NEUEN WGB SCHLÜSSEL MIT ULTRA PRO-TEC-OBERFLÄCHE:

- 15 mal höherer Korrosionsschutz gegen Temperatur-, Streusalz- und Klimabelastungen im Vergleich zu herkömmlich verchromten Schlüsseln
- Bis 720 Stunden im Salznebelprüfetest gemäß DIN EN ISO 9227
- Höchste Beständigkeit gegen „Kontaktkorrosion“
- Umweltfreundliches Chrom-VI freies Beschichtungssystem
- Seit Jahren in der Automobilindustrie erfolgreich eingesetzt

THE NEW WGB COMBINATION SPANNER WITH ULTRA PRO-TEC SURFACE:

- 15 times higher corrosion protection against temperature, road salt and climate loads compared to conventional chrome-plated Combination Spanners
- Up to 720 hours in the salt spray test according to DIN EN ISO 9227
- Highest resistance to „contact corrosion“
- Environmentally friendly chrome VI free coating system
- Successfully used in the automotive industry for years

**ULTRA
PRO-TEC**

15x

*höherer Rostschutz
higher rust protection*





226

ULTRA PRO-TEC RINGMAULSCHLÜSSEL, RINGSEITE 15° ABGEWINKELT, DIN 3113 A
ULTRA PRO-TEC COMBINATION SPANNER, RING 15° OFFSET, DIN 3113 A

ISO 3318, ISO 7738
DIN EN ISO 9227
Chrom-Vanadium Stahl
ULTRA PRO-TEC-Oberfläche

ISO 3318, ISO 7738
DIN EN ISO 9227
Chrome-Vanadium steel
ULTRA PRO-TEC surface



Art.-No.	Ø mm	l-mm-l	g	Box
2260802	8	126	27	10
2260902	9	135	31	10
2261002	10	143	40	10
2261102	11	147	50	10

Art.-No.	Ø mm	l-mm-l	g	Box
2261302	13	172	74	10
2261402	14	181	84	10
2261702	17	210	125	10
2261902	19	234	170	10



226 KSB

ULTRA PRO-TEC RINGMAULSCHLÜSSEL-SATZ, RINGSEITE 15° ABGEWINKELT, DIN 3113 A
ULTRA PRO-TEC COMBINATION SPANNER SET, RING 15° OFFSET, DIN 3113 A

ISO 3318, ISO 7738
DIN EN ISO 9227
Chrom-Vanadium Stahl
ULTRA PRO-TEC-Oberfläche
in Kunststoff-Schiebebox

ISO 3318, ISO 7738
DIN EN ISO 9227
Chrome-Vanadium steel
ULTRA PRO-TEC surface
in plastic sliding box



Art.-No.	No.	Ø mm	g	Box
2260012	226KSB/8	8 9 10 11 13 14 17 19	682	1



234

RINGMAULSCHLÜSSEL EXTRA LANG COMBINATION SPANNER EXTRA LONG

ISO 3318, ISO 7738
Chrom-Vanadium Stahl
verchromt

ISO 3318, ISO 7738
Chrome-Vanadium steel
chrome plated

Art.-No.	Ø mm	l-mm-l	g	📦
2340803	8	149	38	5
2340903	9	160	44	5
2341003	10	166	52	5
2341103	11	185	64	5
2341203	12	195	86	5
2341303	13	203	92	5
2341403	14	223	124	5
2341503	15	233	144	5
2341603	16	240	164	5
2341703	17	262	210	5
2341803	18	270	236	5

Art.-No.	Ø mm	l-mm-l	g	📦
2341903	19	280	254	5
2342103	21	328	320	5
2342203	22	318	356	5
2342403	24	338	452	5
2342703	27	383	628	5
2343003	30	404	786	1
2343203	32	433	1006	1
2343403	34	520	1100	1
2343603	36	550	1320	1
2344103	41	600	1700	1
2344603	46	640	2370	1



234 K

RINGMAULSCHLÜSSEL-SATZ EXTRA LANG COMBINATION SPANNER SET EXTRA LONG

ISO 3318, ISO 7738
Chrom-Vanadium Stahl
verchromt
im Karton

ISO 3318, ISO 7738
Chrome-Vanadium steel
chrome plated
in cardboard box

Art.-No.	No.	Ø mm	g	📦
2340013	234K/8	8 9 10 11 13 14 17 19	1098	1
2340033	234K/10	8 10 13 17 19 22 24 27 30 32	3833	1
2340023	234K/12	10 11 12 13 14 17 19 22 24 27 30 32	4800	1





234 RT

RINGMAULSCHLÜSSEL-SATZ EXTRA LANG
COMBINATION SPANNER SET EXTRA LONG

ISO 3318, ISO 7738
Chrom-Vanadium Stahl
verchromt
in Rolltasche

ISO 3318, ISO 7738
Chrome-Vanadium steel
chrome plated
in roll pouch

Art.-No.	No.	 mm		
2340043	234RT/8	8 9 10 11 13 14 17 19	1520	1



220

RINGMAULSCHLÜSSEL, RINGSEITE GEKRÖPFT, DIN 3113 B COMBINATION SPANNER, RING OFFSET, DIN 3113 B

ISO 3318, ISO 7738
Chrom-Vanadium Stahl | verchromt

ISO 3318, ISO 7738
Chrome-Vanadium steel | chrome plated

Art.-No.	mm	l-mm-l	g	
2200503	5	110	25	10
2200553	5,5	99	18	10
2200603	6	99	16	10
2200703	7	112	21	10
2200803	8	123	28	10
2200903	9	135	33	10
2201003	10	147	40	10
2201103	11	157	50	10
2201203	12	172	60	10
2201303	13	181	80	10
2201403	14	194	86	10
2201503	15	209	110	10
2201603	16	217	126	10
2201703	17	231	154	10
2201803	18	244	165	10
2201903	19	253	202	10
2202003	20	267	215	10
2202103	21	277	250	10
2202203	22	286	276	10
2202303	23	304	310	5
2202403	24	315	351	5

Art.-No.	mm	l-mm-l	g	
2202503	25	326	380	5
2202603	26	338	447	5
2202703	27	351	460	5
2202803	28	365	520	5
2202903	29	365	504	5
2203003	30	388	600	5
2203203	32	410	700	5
2203303	33	410	699	5
2203603	36	463	1080	5
2203803	38	430	1218	5
2204103	41	463	1320	1
2204603	46	520	1674	1
2205003	50	560	2540	1
2205503	55	605	3290	1
2206003	60	673	3530	1
2206503	65	717	4098	1
2207003	70	810	7260	1
2207503	75	803	7274	1
2208003	80	850	8572	1
2208503	85	865	7500	1

220 RT

RINGMAULSCHLÜSSEL-SATZ, RINGSEITE GEKRÖPFT, DIN 3113 B COMBINATION SPANNER SET, RING OFFSET, DIN 3113 B

ISO 3318, ISO 7738
Chrom-Vanadium Stahl | verchromt | in Rolltasche

ISO 3318, ISO 7738
Chrome-Vanadium steel | chrome plated | in roll pouch



Art.-No.	No.	mm	g	
2200173	220RT/08	7 8 10 13 15 17 18 19	769	1
9000833	220RT/8	8 9 10 11 13 14 17 19	1138	1
9000843	220RT/12	6 7 8 9 10 11 12 13 14 17 19 22	1494	1



220 K



RINGMAULSCHLÜSSEL-SATZ, RINGSEITE GEKRÖPFT, DIN 3113 B
COMBINATION SPANNER SET, RING OFFSET, DIN 3113 B

ISO 3318, ISO 7738

Chrom-Vanadium Stahl | verchromt | im Karton

ISO 3318, ISO 7738

Chrome-Vanadium steel | chrome plated | in cardboard box

Art.-No.	No.	Ø mm		
2200093	220K/8	8 9 10 11 13 14 17 19	704	1
2200393	220K/9	10 11 12 13 14 15 17 19 22	1080	1
2200403	220K/10	8 10 11 12 13 14 15 17 19 22	1110	1
2200413	220K/121	6 7 8 9 10 11 12 13 14 15 17 19	1072	1
2200033	220K/12	6 7 8 9 10 11 12 13 14 17 19 22	1072	1
2200113	220K/012	10 11 12 13 14 17 19 22 24 27 30 32	3350	1
2200043	220K/17	6 7 8 9 10 11 12 13 14 15 16 17 18 19 20 21 22	1956	1
2200053	220K/25	6 7 8 9 10 11 12 13 14 15 16 17 18 19 20 21 22 23 24 25 26 27 28 30 32	5760	1



220 S

RINGMAULSCHLÜSSEL-SATZ, RINGSEITE GEKRÖPFT, DIN 3113 B
COMBINATION SPANNER SET, RING OFFSET, DIN 3113 B

ISO 3318, ISO 7738

Chrom-Vanadium Stahl | verchromt | im Sichtkarton

ISO 3318, ISO 7738

Chrome-Vanadium steel | chrome plated | in display cardboard box

Art.-No.	No.	Ø mm		
2200163	220S/8	8 9 10 11 13 14 17 19	704	1

Für alternative Satzbestückung sprechen Sie uns bitte an. | Please ask us for customized set contents.



224

HOT!FORCE RINGMAULSCHLÜSSEL HOT!FORCE COMBINATION SPANNER

DIN ISO 691, DIN ISO 1711
Chrom-Vanadium Stahl
verchromt

DIN ISO 691, DIN ISO 1711
Chrome-Vanadium steel
chrome plated

Art.-No.	Ø mm	l mm	g	Box
2240803	8	152	36	10
2241003	10	152	58	10
2241203	12	167	76	10
2241303	13	175	98	10

Art.-No.	Ø mm	l mm	g	Box
2241403	14	185	108	10
2241503	15	190	138	10
2241703	17	216	170	10
2241903	19	235	234	10

Der Toolbox Ergonomie Tipp:

The Toolbox Ergonomics Tip:

3D Design für bessere Ergonomie

3D design for better ergonomics

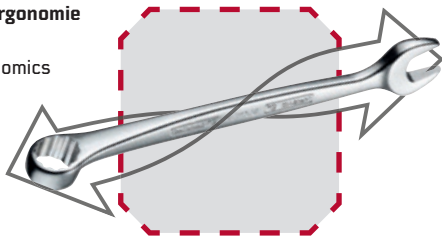

Beim traditionellen 2D Schlüssel wirkt die Kraft nur aus einer Richtung. Das außerordentliche 3D Design der HOT!FORCE Schlüssel bietet höhere Kraft bei geringerem Aufwand.

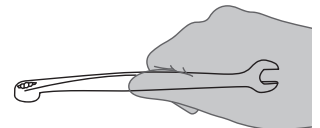

With the traditional 2D wrench, the power only works from one direction. The extraordinary 3D design of the HOT!FORCE wrenches offers greater power with less effort.

Der klassische Schlüssel ist für Arbeiten in eingeschränkten Bereichen nicht geeignet. Mit dem besonderen HOT!FORCE Design der Ringseite lässt sich der Schlüssel auch in eingeschränkten Arbeitsbereichen verwenden.

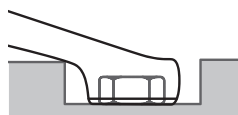

The classic wrench is not suitable for working in restricted areas. With the special HOT!FORCE design on the ring side, the wrench can also be used in restricted work areas.

Der traditionelle Schlüssel lässt sich nur flach auf die Schraube setzen. Durch das spezielle HOT!FORCE Design der Maulseite gleitet der Schlüssel leichter und in natürlich-schräger Haltung auf die Schraube.

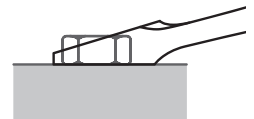

The traditional wrench can only be placed flat on the screw. Because of the HOT!FORCE design of the mouth side the wrench slides easier and naturally inclined on the screw.

Die neue Krüpfung der Maulseite des HOT!FORCE Schlüssels ermöglicht mehr „Fingerfreiheit“ bei bester Kraftübertragung.

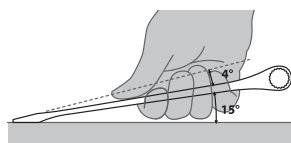

The new cranking of the mouth side of the HOT!FORCE wrench enables more „finger freedom“ with the best power transmission.

Mit dem HOT!FORCE Ringmaulschlüssel erhöht sich der zugängliche Arbeitsbereich um ca. 15%.

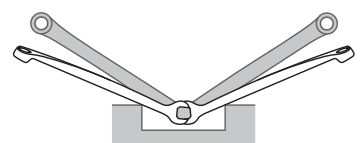

With the HOT!FORCE Combination Spanner the accessible work area increases by ca. 15%.



224 K

HOT!FORCE RINGMAULSCHLÜSSEL-SATZ
HOT!FORCE COMBINATION SPANNER SET

DIN ISO 691, DIN ISO 1711
Chrom-Vanadium Stahl | verchromt
im Kunststoffhalter und Karton

DIN ISO 691, DIN ISO 1711
Chrome-Vanadium steel | chrome plated
in plastic holder and cardboard box

Art.-No.	No.	mm	g	
2240013	224K/8	8 10 12 13 14 15 17 19	1148	1

224 RT

HOT!FORCE RINGMAULSCHLÜSSEL-SATZ
HOT!FORCE COMBINATION SPANNER SET

DIN ISO 691, DIN ISO 1711
Chrom-Vanadium Stahl
verchromt
in Rolltasche

DIN ISO 691, DIN ISO 1711
Chrome-Vanadium steel
chrome plated
in roll pouch



Art.-No.	No.	mm	g	
2240023	224RT/5	8 10 13 17 19	812	1



290

DOPPELRINGSCHLÜSSEL, GEKRÖPFT, DIN 838 DOUBLE ENDED RING SPANNER, OFFSET, DIN 838

ISO 1085, ISO 3318, ISO 10104
Chrom-Vanadium Stahl | verchromt

Art.-No.	Ø mm	l mm	g	Box
2906073	6 x 7	180	50	10
2907083	7 x 8	182	50	10
2908093	8 x 9	190	70	10
2908103	8 x 10	190	67	10
2909113	9 x 11	203	76	10
2910113	10 x 11	203	100	10
2910123	10 x 12	203	87	10
2910133	10 x 13	210	115	10
2911133	11 x 13	214	115	10
2912133	12 x 13	213	130	10
2912143	12 x 14	213	120	10
2913143	13 x 14	227	135	10
2913153	13 x 15	227	125	10
2913163	13 x 16	272	171	10
2913173	13 x 17	250	164	10
2914153	14 x 15	227	150	10
2914173	14 x 17	250	163	10
2916173	16 x 17	250	190	10
2916183	16 x 18	252	178	10
2917193	17 x 19	260	223	10
2918193	18 x 19	260	265	10
2919223	19 x 22	280	291	10

ISO 1085, ISO 3318, ISO 10104
Chrome-Vanadium steel | chrome plated

Art.-No.	Ø mm	l mm	g	Box
2919243	19 x 24	309	350	10
2920223	20 x 22	280	330	10
2921233	21 x 23	309	380	10
2921243	21 x 24	314	380	10
2922243	22 x 24	273	388	10
2922273	22 x 27	273	400	5
2924263	24 x 26	323	420	5
2924273	24 x 27	323	440	5
2924303	24 x 30	343	492	5
2925283	25 x 28	343	497	5
2927303	27 x 30	347	548	5
2927323	27 x 32	359	548	5
2930323	30 x 32	363	660	5
2930343	30 x 34	397	850	5
2930363	30 x 36	399	873	5
2932363	32 x 36	402	950	5
2936413	36 x 41	452	1274	5
2941463	41 x 46	505	1425	1
2946503	46 x 50	542	1750	1
2955603	55 x 60	610	3200	1
2965703	65 x 70	690	4750	1
2975803	75 x 80	800	7000	1

290 S

DOPPELRINGSCHLÜSSEL-SATZ, GEKRÖPFT, DIN 838 DOUBLE ENDED RING SPANNER SET, OFFSET, DIN 838

ISO 1085, ISO 3318, ISO 10104
Chrom-Vanadium Stahl | verchromt | im Sichtkarton

Art.-No.	No.	Ø mm	g	Box
9001603	290S/8	6 x 7 8 x 9 10 x 11 12 x 13 14 x 15 16 x 17 18 x 19 20 x 22	1370	1

Für alternative Satzbestückung sprechen Sie uns bitte an. | Please ask us for customized set contents.

ISO 1085, ISO 3318, ISO 10104
Chrome-Vanadium steel | chrome plated | in display cardboard box





290 K

DOPPELRINGSCHLÜSSEL-SATZ, GEKRÖPFT, DIN 838
DOUBLE ENDED RING SPANNER SET, OFFSET, DIN 838

ISO 1085, ISO 3318, ISO 10104
Chrom-Vanadium Stahl | verchromt
im Karton

ISO 1085, ISO 3318, ISO 10104
Chrome-Vanadium steel | chrome plated
in cardboard box

Art.-No.	No.	Ø mm	g	Box
2900013	290K/6	6 x 7 8 x 9 10 x 11 12 x 13 14 x 15 16 x 17	700	1
2900103	290K/66	6 x 7 8 x 9 10 x 11 12 x 13 14 x 17 19 x 22	1182	1
2900023	290K/8	6 x 7 8 x 9 10 x 11 12 x 13 14 x 15 16 x 17 18 x 19 20 x 22	1238	1
2900043	290K/010	6 x 7 8 x 9 10 x 11 12 x 13 14 x 15 16 x 17 18 x 19 20 x 22 21 x 23 24 x 27	1914	1
2900053	290K/10	6 x 7 8 x 9 10 x 11 12 x 13 14 x 15 16 x 17 18 x 19 20 x 22 24 x 27 30 x 32	2410	1
2900033	290K/12	6 x 7 8 x 9 10 x 11 12 x 13 14 x 15 16 x 17 18 x 19 20 x 22 21 x 23 24 x 27 25 x 28 30 x 32	3260	1



290 RT

DOPPELRINGSCHLÜSSEL-SATZ, GEKRÖPFT, DIN 838
DOUBLE ENDED RING SPANNER SET, OFFSET, DIN 838

ISO 1085, ISO 3318, ISO 10104
Chrom-Vanadium Stahl
verchromt
in Rolltasche

ISO 1085, ISO 3318, ISO 10104
Chrome-Vanadium steel
chrome plated
in roll pouch

Art.-No.	No.	Ø mm	g	Box
9001523	290RT/6	6 x 7 8 x 9 10 x 11 12 x 13 14 x 15 16 x 17	1075	1
9001533	290RT/8	6 x 7 8 x 9 10 x 11 12 x 13 14 x 15 16 x 17 18 x 19 20 x 22	1576	1
2900093	290RT/08	6 x 7 8 x 9 10 x 11 12 x 13 14 x 15 16 x 17 18 x 19 21 x 23	1152	1
9003883	290RT/12	6 x 7 8 x 9 10 x 11 12 x 13 14 x 15 16 x 17 18 x 19 20 x 22 21 x 23 24 x 27 25 x 28 30 x 32	3455	1

Für alternative Satzbestückung sprechen Sie uns bitte an. | Please ask us for customized set contents.



210

DOPPELRINGSCHLÜSSEL, GERADE, DIN 837 B DOUBLE ENDED RING SPANNER, STRAIGHT, DIN 837 B

ISO 1085, ISO 3318
Chrom-Vanadium Stahl
verchromt

ISO 1085, ISO 3318
Chrome-Vanadium steel
chrome plated

Art.-No.	Ø mm	l mm	g	Box
2106073	6 x 7	97	18	10
2108093	8 x 9	111	22	10
2108103	8 x 10	117	25	10
2110113	10 x 11	127	35	10
2110133	10 x 13	142	41	10
2112133	12 x 13	142	48	10
2112143	12 x 14	142	61	10
2113153	13 x 15	155	65	10
2113173	13 x 17	166	75	10
2114153	14 x 15	155	65	10

Art.-No.	Ø mm	l mm	g	Box
2116173	16 x 17	170	60	10
2117193	17 x 19	185	100	10
2118193	18 x 19	185	80	10
2119223	19 x 22	208	139	10
2120223	20 x 22	201	135	10
2121233	21 x 23	214	150	10
2122243	22 x 24	214	165	10
2124273	24 x 27	262	184	10
2125283	25 x 28	263	270	10
2130323	30 x 32	283	333	10



210 K

DOPPELRINGSCHLÜSSEL-SATZ, GERADE, DIN 837 B DOUBLE ENDED RING SPANNER SET, STRAIGHT, DIN 837 B

ISO 1085, ISO 3318
Chrom-Vanadium Stahl
verchromt
im Karton

ISO 1085, ISO 3318
Chrome-Vanadium steel
chrome plated
in cardboard box

Art.-No.	No.	Ø mm	g	Box
2100033	210K/6	6 x 7 8 x 9 10 x 11 12 x 13 14 x 15 16 x 17	201	1
2100013	210K/8	6 x 7 8 x 9 10 x 11 12 x 13 14 x 15 16 x 17 18 x 19 20 x 22	386	1
2100103	210K/10	6 x 7 8 x 9 10 x 11 12 x 13 14 x 15 16 x 17 18 x 19 20 x 22 24 x 27 30 x 32	1006	1
2100023	210K/12	6 x 7 8 x 9 10 x 11 12 x 13 14 x 15 16 x 17 18 x 19 20 x 22 21 x 23 24 x 27 25 x 28 30 x 32	1204	1

Für alternative Satzbestückung sprechen Sie uns bitte an. | Please ask us for customized set contents.



610

ELEKTRIKER-DOPPELMAULSCHLÜSSEL ELECTRICIAN'S DOUBLE OPEN ENDED SPANNER

Chrom-Vanadium Stahl | verchromt Chrome-Vanadium steel | chrome plated
mit gleichen Schlüsselweiten same size at both ends
flache Köpfe flat heads
15° und 75° abgewinkelt angled at 15° and 75°

Art.-No.	Ø mm	l-mm-l	g	📦
6103203	3,2	70	6	10
6103503	3,5	70	6	10
6104003	4	70	6	10
6104503	4,5	75	8	10
6105003	5	75	8	10
6105503	5,5	76	8	10
6106003	6	80	12	10
6107003	7	80	12	10
6108003	8	90	18	10
6109003	9	90	18	10
6110003	10	100	22	10
6111003	11	100	22	10
6112003	12	120	38	10
6113003	13	120	36	10
6114003	14	121	36	10

240

DOPPELRINGSCHLÜSSEL, OFFEN, DIN 3118 A FLARE NUT SPANNER, DIN 3118 A

Chrom-Vanadium Stahl Chrom-Vanadium steel
verchromt chrome plated

Art.-No.	Ø mm	l-mm-l	g	📦
2408093	8 x 9	134	41	10
2408103	8 x 10	135	40	10
2409113	9 x 11	152	56	10
2410113	10 x 11	145	50	10
2410123	10 x 12	152	54	10
2411133	11 x 13	170	108	10
2412143	12 x 14	174	96	10
2413153	13 x 15	165	104	10
2414163	14 x 16	186	122	10
2414173	14 x 17	182	144	10
2416183	16 x 18	205	158	10
2417193	17 x 19	198	156	10
2419223	19 x 22	203	260	5
2422243	22 x 24	226	330	5
2424273	24 x 27	254	422	5
2430323	30 x 32	275	392	5



Satz auf Anfrage | Set on request

675

STARTER- UND BLOCKSCHLÜSSEL HALF MOON RING SPANNER

Chrom-Vanadium Stahl | verchromt

Art.-No.	mm	l-mm-l	g	
9224343	11 x 13	150	79	10
9202933	12 x 13	151	54	10
9202943	13 x 15	170	110	10
9202973	14 x 16	183	143	10

Satz auf Anfrage



Chrom-Vanadium steel | chrome plated

Art.-No.	mm	l-mm-l	g	
9202953	14 x 17	185	164	10
9202983	15 x 17	181	164	10
9202993	16 x 18	200	164	10
9202963	19 x 22	218	257	10

Set on request

215

DOPPELRINGSCHLÜSSEL AUSSEN-TORX®-SCHRAUBEN DOUBLE ENDED RING SPANNER FOR OUTSIDE TORX® SCREWS

Chrom-Vanadium Stahl | verchromt | Köpfe poliert

Art.-No.	mm	l-mm-l	g	
9244478	E6 x E8	110	22	10
9245208	E10 x E12	140	46	10

Satz auf Anfrage



Chrom-Vanadium steel | chrome plated | polished heads

Art.-No.	mm	l-mm-l	g	
9248108	E14 x E18	180	96	10
9248118	E20 x E24	223	172	10

Set on request

580

GELENK-STECKSCHLÜSSEL COMBINATION SWIVEL HEAD WRENCH

Chrom-Vanadium Stahl | verchromt

Art.-No.	mm	l-mm-l	g	
5800808	8	161	55	10
5801008	10	182	79	10
5801208	12	211	145	10

Chrom-Vanadium steel | chrome plated

Art.-No.	mm	l-mm-l	g	
5801308	13	211	143	5
5801708	17	245	190	5





235

RINGMAULSCHLÜSSEL MIT RATSCH E UND STOPRING COMBINATION GEAR WRENCH WITH STOPRING

DIN ISO 691, DIN ISO 1711

Chrom-Vanadium Stahl

verchromt

abgewinkelt

umschaltbar

72 Zähne

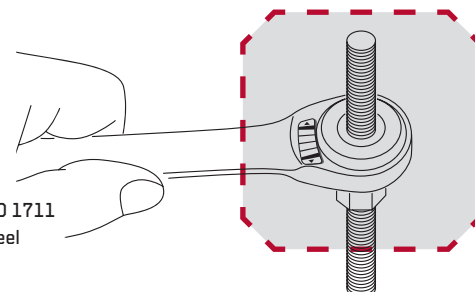

DIN ISO 691, DIN ISO 1711

Chrome-Vanadium steel

chrome plated

offset

reversible

72 teeth

Art.-No.	Ø mm	l mm	g	Box
23500063	6	135	38	1
23500073	7	134	35	1
23500083	8	134	35	10
23500093	9	158	62	10
23500103	10	158	60	10
23500113	11	164	72	10
23500123	12	167	84	10
23500133	13	177	100	10
23500143	14	190	120	10
23500153	15	198	140	10

Art.-No.	Ø mm	l mm	g	Box
23500163	16	204	160	10
23500173	17	224	180	10
23500183	18	235	212	10
23500193	19	247	242	10
23500223	22	280	374	10
23500243	24	310	500	10
23500273	27	330	635	5
23500303	30	425	1160	5
23500323	32	425	1150	5



235 RT

RINGMAULSCHLÜSSEL-SATZ MIT RATSCH E COMBINATION GEAR WRENCH SET

DIN ISO 691, DIN ISO 1711

Chrom-Vanadium Stahl

verchromt

abgewinkelt

umschaltbar

72 Zähne

in Rolltasche

DIN ISO 691, DIN ISO 1711

Chrome-Vanadium steel

chrome plated

offset

reversible

72 teeth

in roll pouch

Art.-No.	No.	Inhalt Content	g	Box
23500983	235RT/5	8 10 13 17 19	850	1
23500973	235RT/8	8 10 13 14 15 17 19 22	1350	1



237

RINGMAULSCHLÜSSEL MIT RATSCH COMBINATION GEAR WRENCH

DIN ISO 691, DIN ISO 1711

Chrom-Vanadium Stahl

verchromt

abgewinkelt

umschaltbar

72 Zähne

DIN ISO 691, DIN ISO 1711

Chrome-Vanadium steel

chrome plated

offset

reversible

72 teeth

Art.-No.	mm	l-mm-l	g	
23700073	7	124	35	10
23700083	8	136	38	10
23700093	9	142	44	10
23700103	10	158	57	10
23700123	12	173	83	10
23700133	13	179	103	10
23700143	14	188	120	10
23700153	15	190	138	10
23700163	16	215	171	10

Art.-No.	mm	l-mm-l	g	
23700173	17	232	200	10
23700183	18	238	219	10
23700193	19	247	252	10
23700223	22	283	341	10
23700243	24	324	480	10
23700273	27	355	651	5
23700303	30	425	927	5
23700323	32	422	957	5
23700363	36	480	1505	1



237 KSB

RINGMAULSCHLÜSSEL-SATZ MIT RATSCH COMBINATION GEAR WRENCH SET

DIN ISO 691, DIN ISO 1711

Chrom-Vanadium Stahl

verchromt

abgewinkelt

umschaltbar

72 Zähne

in Kunststoffschiebox

DIN ISO 691, DIN ISO 1711

Chrome-Vanadium steel

chrome plated

offset

reversible

72 teeth

in plastic sliding box

Art.-No.	No.	Inhalt Content	g	
23700503	237KSB/5	8 10 13 17 19	775	1
23700803	237KSB/8	8 10 13 14 15 17 19 22	1375	1
23701203	237KSB/12	8 10 13 16 17 18 19 22 24 27 30 32	4520	1



236

RINGMAULSCHLÜSSEL MIT RATSCH COMBINATION GEAR WRENCH

DIN ISO 691, DIN ISO 1711

Chrom-Vanadium Stahl

verchromt

gerade

72 Zähne

DIN ISO 691, DIN ISO 1711

Chrome-Vanadium steel

chrome plated

straight

72 teeth

Art.-No.	mm	l-mm-l	g	
23600063	6	134	37	10
23600073	7	134	38	10
23600083	8	134	40	10
23600103	10	159	62	10
23600133	13	178	100	10
23600143	14	190	111	10
23600153	15	198	136	10
23600163	16	205	153	10
23600173	17	224	190	10

Art.-No.	mm	l-mm-l	g	
23600183	18	235	199	10
23600193	19	247	244	10
23600213	21	280	368	10
23600223	22	280	352	10
23600243	24	310	493	10
23600273	27	330	579	5
23600303	30	425	1140	5
23600323	32	425	1170	5



236 RT

RINGMAULSCHLÜSSEL-SATZ MIT RATSCH COMBINATION GEAR WRENCH SET

DIN ISO 691, DIN ISO 1711

Chrom-Vanadium Stahl

verchromt

gerade

72 Zähne

in Rolltasche

DIN ISO 691, DIN ISO 1711

Chrome-Vanadium steel

chrome plated

straight

72 teeth

in roll pouch

Art.-No.	No.	Inhalt Content	g	
23600983	236RT/5	8 10 13 17 19	850	1
23600973	236RT/8	8 10 13 14 15 17 19 22	1450	1



295

DOPPELRING-RATSCHENSCHLÜSSEL MIT STOPRING DOUBLE-BOX GEAR WRENCH WITH STOPRING

DIN ISO 691, DIN ISO 1711
Chrom-Vanadium Stahl
verchromt
abgewinkelt
beidseitig umschaltbar
72 Zähne

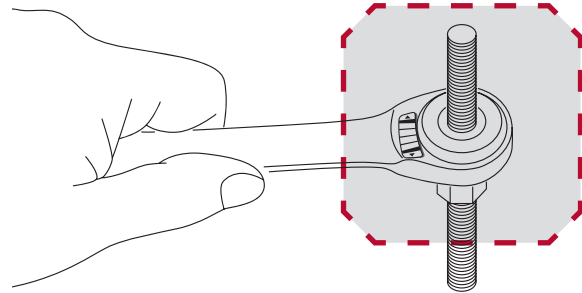

DIN ISO 691, DIN ISO 1711
Chrome-Vanadium steel
chrome plated
offset
reversible on both sides
72 teeth

Art.-No.	mm	l-mm-l	g	☐
29508093	8 x 9	130	59	10
29510113	10 x 11	144	73	10
29510133	10 x 13	144	98	10
29512133	12 x 13	166	100	10

Art.-No.	mm	l-mm-l	g	☐
29514153	14 x 15	181	150	10
29516183	16 x 18	206	192	10
29517193	17 x 19	224	222	10

295 RT

DOPPELRING-RATSCHENSCHLÜSSEL-SATZ DOUBLE-BOX GEAR WRENCH SET

DIN ISO 691, DIN ISO 1711
Chrom-Vanadium Stahl | verchromt
abgewinkelt
beidseitig umschaltbar
72 Zähne
in Rolltasche

DIN ISO 691, DIN ISO 1711
Chrome-Vanadium steel | chrome plated
offset
reversible on both sides
72 teeth
in roll pouch



Art.-No.	No.	Inhalt Content	g	☐
29500023	295RT/5	8 x 9 10 x 11 12 x 13 14 x 15 17 x 19	809	1

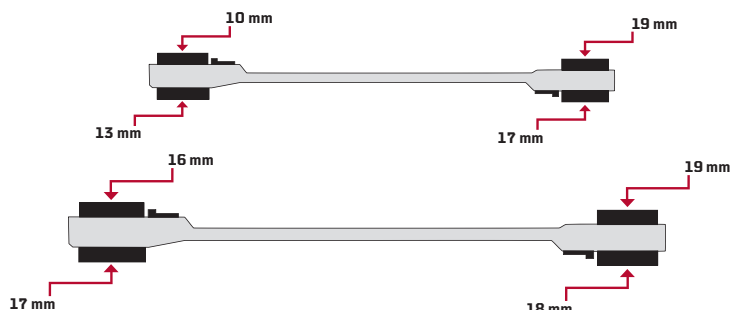
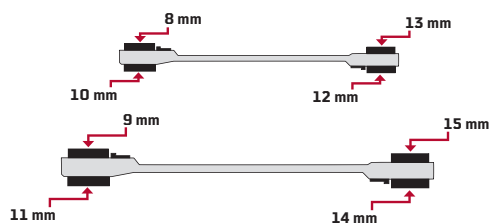

297

4 IN 1 DOPPELRING-RATSCHENSCHLÜSSEL 4 IN 1 DOUBLE-BOX GEAR WRENCH

DIN ISO 691, DIN ISO 1711
 Chrom-Vanadium Stahl
 verchromt
 gerade
 beidseitig umschaltbar
 72 Zähne

DIN ISO 691, DIN ISO 1711
 Chrome-Vanadium steel
 chrome plated
 straight
 reversible on both sides
 72 teeth

Art.-No.	Ø mm	l-mm-l	g	📦
29708133	8 x 10 x 12 x 13	165	100	10
29709153	9 x 11 x 14 x 15	181	154	10

Art.-No.	Ø mm	l-mm-l	g	📦
29710193	10 x 13 x 17 x 19	206	188	10
29716193	16 x 17 x 18 x 19	224	230	10



297 KSB

4 IN 1 DOPPELRING-RATSCHENSCHLÜSSEL-SATZ 4 IN 1 DOUBLE-BOX GEAR WRENCH SET

DIN ISO 691, DIN ISO 1711
 Chrom-Vanadium Stahl | verchromt
 gerade
 beidseitig umschaltbar
 72 Zähne
 in Kunststoffschiebox

DIN ISO 691, DIN ISO 1711
 Chrome-Vanadium steel | chrome plated
 straight
 reversible on both sides
 72 teeth
 in plastic sliding box

Art.-No.	No.	Inhalt Content	g	📦
9012900	297KSB/3	8 x 10 x 12 x 13 9 x 11 x 14 x 15 16 x 17 x 18 x 19	594	1

620

ROLLGABELSCHLÜSSEL, DIN 3117 B ADJUSTABLE WRENCH, DIN 3117 B

ISO 6787
Chrom-Vanadium Stahl | verchromt
2-Komponentenheft | mit Aufhängeloch



ISO 6787
Chrome-Vanadium steel | chrome plated
two component handle | with hanging hole

Art.-No.	L	mm	mm	g	
9263458	6"	max. 19	150	150	10
9263468	8"	max. 24	200	268	10
9263478	10"	max. 29	250	409	5
9265588	12"	max. 33	300	686	5

621

ROLLGABELSCHLÜSSEL, DIN 3117 B ADJUSTABLE WRENCH, DIN 3117 B

ISO 6787
Chrom-Vanadium Stahl | phosphatiert | Heft mit Aufhängeloch
mit Skala



ISO 6787
Chrome-Vanadium steel | phosphated | handle with hanging hole
with scale

Art.-No.	L	mm	mm	g	
6210601	6"	max. 19	150	121	10
6210801	8"	max. 24	200	260	10
6211001	10"	max. 29	250	390	5
6211201	12"	max. 33	300	690	5
6211501	15"	max. 43	375	1204	5
6211801	18"	max. 52	450	1914	5
6212401	24"	max. 62	600	3188	5

623

ROLLGABELSCHLÜSSEL MIT SOFTGRIFF, DIN 3117 B ADJUSTABLE WRENCH WITH SOFTGRIP-HANDLE, DIN 3117 B

ISO 6787
Chrom-Vanadium Stahl | verchromt
2-Komponentenheft | mit Aufhängeloch
mit Skala



ISO 6787
Chrome-Vanadium steel | chrome plated
two component handle | with hanging hole
with scale

Art.-No.	L	mm	mm	g	
6230603	6"	max. 19	150	126	10
6230803	8"	max. 24	200	248	10
6231003	10"	max. 29	250	400	5
6231203	12"	max. 33	300	602	5



MIT RATSCHHE

WITH RATCHET



624

ROLLGABELSCHLÜSSEL MIT RATSCHENFUNKTION, DIN 3117 B
ADJUSTABLE-WRENCH WITH RATCHET-FUNCTION, DIN 3117B



ISO 6787
Chrom-Vanadium Stahl
verchromt
2-Komponentenheft
mit Aufhängeloch
mit Skala

ISO 6787
Chrome-Vanadium steel
chrome plated
two component handle
with hanging hole
with scale

Art.-No.	l - L - l	mm	l - mm - l	g	
6240603	6"	max. 19	164	140	10
6240803	8"	max. 24	210	284	10
6241003	10"	max. 29	255	517	5

So funktioniert's:

Here's how it works:

Schlüsselweite einstellen

Set wrench size

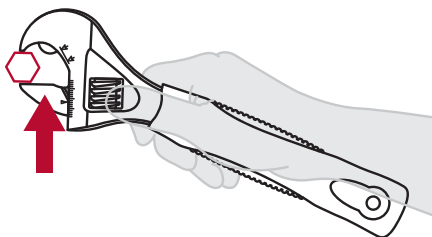

Rollgabelschlüssel in Schraubposition vorschieben

Push Adjustable Wrench into screw position

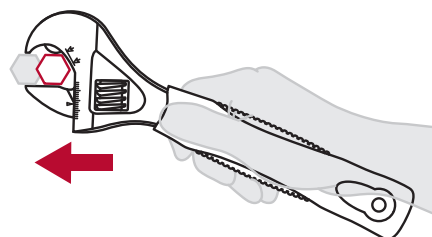

Schraube festdrehen, ohne abzusetzen – zum Lösen der Schraube den Schlüssel wenden

Tighten screw without removing – turn wrench over to loose the screw

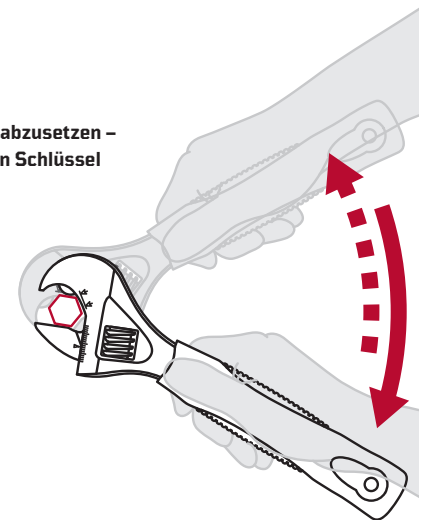

510

STIRNLOCHSCHLÜSSEL ADJUSTABLE PIN WRENCH

verstellbar für Zweilochmuttern
Chrom-Vanadium Stahl
schwarz

for nuts with 2 holes
Chrome-Vanadium steel
black

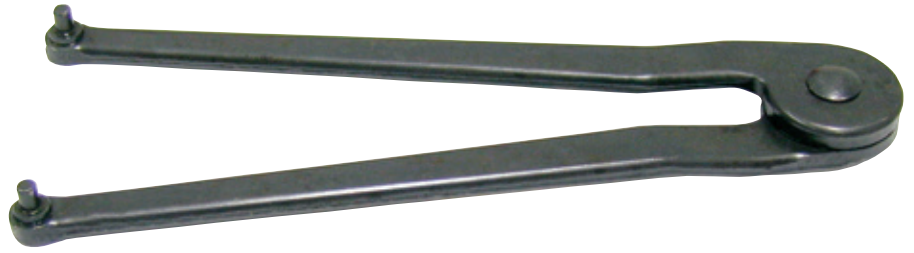

Art.-No.	Ø mm	Zapfen Pin	l-mm-l	g	
5100021*	7-40	2	115	38	10
5100031	11-60	3	178	111	10
5100041	11-60	4	178	156	10

* Spezial-Werkzeugstahl | schwarz

Art.-No.	Ø mm	Zapfen Pin	l-mm-l	g	
5100051	14-100	5	230	210	5
5100061	14-100	6	230	295	5
5100081	22-125	8	230	210	5

* Special Carbon steel | black

515

GELENK-HAKENSCHLÜSSEL HINGED HOOK WRENCH

DIN 1810 A
mit Nase für Nutmuttern DIN 1804
und Wälzlagermuttern DIN 981
Spezial-Werkzeugstahl
brüniert

DIN 1810 A
with nose for slotted round nuts DIN 1804
and bearing nuts DIN 981
Special Carbon steel
gun finished



Art.-No.	Größe Size	l-mm-l	g	
9219361	20-35	165	85	10
9219371	35-60	188	100	10
9215371	60-90	252	265	5

Art.-No.	Größe Size	l-mm-l	g	
9223331	90-155	285	445	1
9215381	155-230	383	1200	1

516

GELENK-HAKENSCHLÜSSEL HINGED HOOK WRENCH

DIN 1810 B
mit Zapfen für Kreuzlochmuttern DIN 1816
Spezial-Werkzeugstahl
brüniert

DIN 1810 B
with pin for nuts with radial holes DIN 1816
Special Carbon steel
gun finished



Art.-No.	Größe Size	Zapfen Pin	l-mm-l	g	
9222851	22-35	2,9	165	97	10
9222861	35-60	4,0	205	170	10
9222871	60-90	5,5	280	380	10

Art.-No.	Größe Size	Zapfen Pin	l-mm-l	g	
9222881	95-155	6,0	335	610	10
9227721	165-230	9,5	385	1200	1



680

HAKESCHLÜSSEL HOOK WRENCH

DIN 1810 A
mit Nase für Nutmuttern DIN 1804 und Wälzlagermuttern DIN 981
Chrom-Vanadium Stahl
brüniert

DIN 1810 A
with nose for slotted round nuts DIN 1804 and bearing nuts DIN 981
Chrome-Vanadium steel
gun finished

Art.-No.	Größe Size	l-mm-l		
6800161	16-20	108	24	10
6800251	25-28	136	46	10
6800301	30-32	135	54	10
6800341	34-36	168	95	10
6800401	40-42	170	96	10
6800451	45-50	205	169	10
6800521	52-55	205	156	10
6800581	58-62	245	238	10
6800681	68-75	242	176	10

Art.-No.	Größe Size	l-mm-l		
6800801	80-90	280	425	5
6800951	95-100	280	390	5
6801101	110-115	335	608	5
6801201	120-130	332	741	5
6801351	135-145	385	1000	5
6801551	155-165	382	1224	1
6801801	180-195	463	1494	1
6802051	205-220	470	1488	1



681

HAKESCHLÜSSEL HOOK WRENCH

DIN 1810 B
mit Zapfen für Kreuzlochmuttern DIN 1816
Chrom-Vanadium Stahl
brüniert

DIN 1810 B
with pin for nuts with radial holes DIN 1816
Chrome-Vanadium steel
gun finished

Art.-No.	Größe Size	Zapfen Pin	l-mm-l		
9207921	12-14	2,0	110	25	10
9202231	16-18	2,5	109	22	10
9202241	20-22	2,5	109	21	10
9202251	25-28	3,0	135	47	10
9202261	30-32	4,0	135	53	10
9202271	34-36	4,0	170	88	10
9202281	40-42	4,0	170	99	10
9202291	45-50	5,0	206	176	10
9202301	52-55	5,0	206	175	10
9202311	58-62	5,0	243	236	10

Art.-No.	Größe Size	Zapfen Pin	l-mm-l		
9202321	68-75	6,0	240	257	5
9202331	80-90	6,0	280	400	5
9202341	95-100	8,0	280	400	5
9202351	110-115	8,0	336	738	5
9202361	120-130	8,0	334	746	5
9202371	135-145	8,0	385	1265	5
9202381	155-165	8,0	380	1246	5
9202391	180-195	10,0	468	1580	1
9202401	205-220	10,0	467	1580	1



250

AUFSTECK-RINGZUGSCHLÜSSEL HEAVY DUTY RING SPANNER

DIN ISO 691
Chrom-Vanadium Stahl
verchromt

DIN ISO 691
Chrome-Vanadium steel
chrome plated

Art.-No.	Ø mm	l mm	g	Box
2502203	22	180	380	5
2502403	24	180	464	5
2502703	27	190	466	5
2503003	30	200	514	5
2503203	32	235	710	5
2503603	36	245	786	5
2504103	41	265	916	5
2504603	46	280	1422	1
2505003	50	290	1390	1
2505503	55	300	1496	1

Aufsteckbare Rohre Nr. 260 bitte extra bestellen

Art.-No.	Ø mm	l mm	g	Box
2506003	60	345	2250	1
2506503	65	355	2600	1
2507003	70	360	2730	1
2507503	75	375	2980	1
2508003	80	390	3770	1
2508503	85	390	3060	1
2509003	90	420	4550	1
2509503	95	410	5200	1
2510003	100	410	4800	1
2510503	105	410	4600	1

Tubular Handles No. 260 to be ordered separately



260

AUFSTECKROHR TUBULAR HANDLE

für Aufsteck-Ringzugschlüssel Nr. 250
Chrom-Vanadium Stahl
verchromt

for heavy duty ring spanner No. 250
Chrome-Vanadium steel
chrome plated

Art.-No.	No.	Ø mm	l mm	g	Box
2600013	1	22-30	463	600	1
2600023	2	32-41	610	1098	1

Art.-No.	No.	Ø mm	l mm	g	Box
2600033	3	46-55	760	2172	1
2600043	4	60-105	862	2920	1



270

SCHLAGRINGSCHLÜSSEL, DIN 7444 SLUGGING RING WRENCH, DIN 7444

Chrom-Vanadium Stahl bis 140 mm, Chrome-Vanadium steel up to 140 mm,
Spezial-Werkzeugstahl ab 145 mm Special Carbon steel from 145 mm
phosphatiert phosphated

Art.-No.	Ø mm	l mm	g	Box
2702204	22	167	250	5
2702404	24	167	230	5
2702604	26	180	265	5
2702704	27	180	280	5
2703004	30	190	380	5
2703204	32	195	400	5
2703404	34	196	450	5
2703604	36	205	580	5
2703804	38	215	650	5
2704104	41	230	750	5
2704604	46	240	900	5
2705004	50	255	1200	1
2705504	55	265	1350	1
2706004	60	275	1500	1
2706504	65	295	2100	1
2707004	70	320	2900	1
2707504	75	330	2950	1
2708004	80	363	4280	1
2708504	85	360	4044	1
2709004	90	400	6978	1
2709504	95	400	6520	1
2710004	100	407	6500	1
2710504	105	433	9200	1
2711004	110	440	9000	1
2711504	115	447	8840	1
2712004	120	477	11320	1
2712504	125	480	10916	1
2713004	130	520	14290	1
2713504	135	520	14580	1
2714004	140	520	13550	1
2714507	145	565	18100	1
2715007	150	565	18000	1
2715507	155	565	14695	1
2716007	160	580	16000	1
2716507	165	630	23000	1
2717007	170	630	23000	1
2717507	175	630	22500	1
2718007	180	630	22000	1
2718507	185	685	34000	1

280

EINRINGSCHLÜSSEL, GERADE, DIN 3111 DEEP RING SPANNER, STRAIGHT, DIN 3111

Spezial-Werkzeugstahl phosphatiert Special Carbon steel phosphated

Art.-No.	Ø mm	l mm	g	Box
2801404	14	145	56	10
2801704	17	155	79	10
2801904	19	170	100	10
2802204	22	190	160	10
2802404	24	215	199	10
2802704	27	230	255	10
2803004	30	255	315	10
2803204	32	265	325	10
2803604	36	295	479	5
2804104	41	330	721	5
2804604	46	365	919	5
2805004	50	400	1188	1
2805504	55	445	1628	1
2806004	60	474	1764	1
2806504	65	510	2200	1
2807004	70	555	2750	1
2807504	75	590	3250	1
2808004	80	620	3850	1
2808504	85	620	4400	1
2809004	90	650	5650	1
2809504	95	650	5800	1

670

SCHLAGMAULSCHLÜSSEL, DIN 133 SLUGGING OPEN JAW WRENCH, DIN 133

Chrom-Vanadium Stahl bis 100 mm,
Spezial-Werkzeugstahl ab 105 mm
phosphatiert

Chrome-Vanadium steel up to 100 mm,
Special Carbon steel from 105 mm
phosphated



Art.-No.	Ø mm	l-mm-l	g	
6702407	24	176	274	5
6702707	27	175	420	5
6703007	30	190	510	5
6703207	32	195	570	5
6703407	34	200	700	5
6703607	36	205	700	5
6703807	38	205	680	5
6704107	41	230	950	5
6704607	46	250	1300	5
6705007	50	270	1600	5
6705507	55	304	2200	1
6706007	60	315	2700	1
6706507	65	340	3350	1
6707007	70	373	4450	1
6707507	75	380	4950	1
6708007	80	407	6500	1
6708507	85	407	6300	1
6709007	90	452	9250	1
6709507	95	452	9150	1
6710007	100	485	11425	1
6710507	105	485	10300	1

Art.-No.	Ø mm	l-mm-l	g	
6711007	110	510	13500	1
6711507	115	510	13500	1
6712007	120	530	19200	1
6712507	125	530	19200	1
6713007	130	560	19500	1
6713507	135	560	18950	1
6714007	140	630	20000	1
6714507	145	630	23500	1
6715007	150	630	22500	1
6715507	155	645	23900	1
6716007	160	645	25500	1
6716507	165	705	37500	1
6717007	170	705	37000	1
6717507	175	720	38270	1
6718007	180	720	36600	1
6718507	185	755	39000	1
6719007	190	755	42000	1
6719507	195	770	39000	1
6720007	200	770	52500	1
6720507	205	820	52500	1
6721007	210	820	51700	1

450

DOPPELSEITIGER ROHRSTECKSCHLÜSSEL, DIN 896 B DOUBLE ENDED TUBULAR BOX WRENCH, DIN 896 B

ISO 1085, ISO 2236
nahtlos gezogenes
Präzisions-Stahlrohr, gehärtet
verchromt

ISO 1085, ISO 2236
seamless rifled
precision steel tube, hardened
chrome plated



Art.-No.	Ø mm	mm	l-mm-l	g	
4506073	6 x 7	6 x 160	103	36	10
4508093	8 x 9	6 x 160	105	38	10
4508103	8 x 10	6 x 160	120	46	10
4510113	10 x 11	6 x 160	119	73	10
4510133	10 x 13	8 x 180	140	90	10
4512133	12 x 13	8 x 180	140	85	10
4513143	13 x 14	8 x 180	132	70	10
4513153	13 x 15	8 x 180	140	94	10
4513173	13 x 17	10 x 200	154	116	10
4514153	14 x 15	8 x 180	140	94	10
4514173	14 x 17	10 x 200	152	125	10
4516173	16 x 17	10 x 200	154	118	10
4517193	17 x 19	12 x 250	155	175	10
4518193	18 x 19	12 x 250	155	170	10
4519223	19 x 22	12 x 250	169	230	5

Art.-No.	Ø mm	mm	l-mm-l	g	
4520223	20 x 22	12 x 250	169	235	5
4521233	21 x 23	14 x 320	168	238	5
4522243	22 x 24	14 x 320	183	344	5
4524263	24 x 26	14 x 320	190	360	5
4524273	24 x 27	14 x 320	189	370	5
4525283	25 x 28	14 x 320	200	390	5
4527323	27 x 32	16 x 400	205	392	5
4530323	30 x 32	16 x 400	200	395	5
4530363	30 x 36	18 x 400	220	545	5
4532363	32 x 36	18 x 400	218	600	2
4536413	36 x 41	18 x 400	222	658	1
4541463	41 x 46	20 x 500	242	966	1
4546503	46 x 50	20 x 500	245	927	1
4550553	50 x 55	20 x 500	242	1670	1

450 K

DOPPELSEITIGER ROHRSTECKSCHLÜSSEL-SATZ, DIN 896 B DOUBLE ENDED TUBULAR BOX WRENCH SET, DIN 896 B

DIN ISO 1085, ISO 2236
nahtlos gezogenes
Präzisions-Stahlrohr, gehärtet
verchromt
im Karton

DIN ISO 1085, ISO 2236
seamless rifled
precision steel tube, hardened
chrome plated
in cardboard box



Art.-No.	No.	Ø mm	g	
4500013	450K/8	6 x 7 8 x 9 10 x 11 12 x 13 14 x 15 16 x 17 18 x 19 20 x 22	750	1
4500035	450K/8	8 x 9 10 x 11 12 x 13 14 x 15 16 x 17 18 x 19 20 x 22 + Stufendrehstift / Tommy Bar	1060	1
4500065	450K/9	6 x 7 8 x 9 10 x 11 12 x 13 14 x 15 16 x 17 18 x 19 20 x 22 + Stufendrehstift / Tommy Bar	1146	1
4500043	450K/12	6 x 7 8 x 9 10 x 11 12 x 13 14 x 15 16 x 17 18 x 19 20 x 22 21 x 23 24 x 27 25 x 28 30 x 32	1985	1

Für alternative Satzbestückung sprechen Sie uns bitte an. | Please ask us for customized set contents.

413

ZÜNDKERZEN-KOMBINATIONSSCHLÜSSEL COMBINATION SPARK PLUG WRENCH

ISO 1085, ISO 2236

nahtlos gezogenes

Präzisions-Stahlrohr, gehärtet | verchromt



ISO 1085, ISO 2236

seamless rifled

precision steel tube, hardened | chrome plated

Art.-No.	Ø mm	mm	mm	l-mm-l	g	📦
41310163	10 x 16	6	140	162	100	10
41311163	11 x 16	6	140	162	110	10
41313163	13 x 16	6	160	180	102	10
41313193	13 x 19	6	140	162	114	10
41317193	17 x 19	6	160	188	116	5
41317213	17 x 21	6	160	188	118	5

462

RAD-STECKSCHLÜSSEL DOUBLE ENDED WHEEL NUT WRENCH

massiv

Spezial-Werkzeugstahl

chromfarbig lackiert

mit Drehstift



heavy duty pattern

Special Carbon steel

silver finished

with Tommy Bar

Art.-No.	Ø mm	mm	l-mm-l	g	📦
9209180	24 x 27	19 x 400	405	1280	1
9216800	27 x 30	19 x 400	405	2900	1
9209200	30 x 32	19 x 400	450	2970	1
9209220	32 x 38	19 x 400	505	3640	1

460

RAD-STECKSCHLÜSSEL EXTRA LANG SINGLE ENDED WHEEL NUT WRENCH EXTRA LONG

massiv

Spezial-Werkzeugstahl

chromfarbig lackiert

mit Drehstift



heavy duty pattern

Special Carbon steel

silver finished

with Tommy Bar

Art.-No.	Ø mm	mm	l-mm-l	g	📦
9294919	19	14 x 320	330	834	5



455

DOPPELSEITIGER ROHRSTECKSCHLÜSSEL DOUBLE ENDED TUBULAR BOX WRENCH

massiv
Chrom-Vanadium Stahl
verchromt

heavy duty pattern
Chrome-Vanadium steel
chrome plated

Art.-No.	mm	mm	l-mm-l	g	
45506073	6 x 7	3 x 110	105	37	10
45508093	8 x 9	3 x 110	110	52	10
45510113	10 x 11	5 x 125	120	72	10
45512133	12 x 13	5 x 125	140	117	10
45514153	14 x 15	6 x 160	145	145	10
45516173	16 x 17	8 x 180	155	189	10
45517193	17 x 19	8 x 180	165	233	10
45518193	18 x 19	8 x 180	165	242	10
45520223	20 x 22	10 x 200	175	306	5
45521233	21 x 23	10 x 200	185	340	5
45524263	24 x 26	10 x 200	194	481	5
45524273	24 x 27	10 x 200	195	493	5
45525283	25 x 28	10 x 200	202	481	5
45530323	30 x 32	12 x 250	210	725	5



470

STECKSCHLÜSSEL, ABGEWINKELT SOCKET WRENCH, ANGLED

massiv
Spezial-Werkzeugstahl
chromfarbig lackiert

heavy duty pattern
Special Carbon steel
silver finished

Art.-No.	mm	l-mm-l	g	
4701700	17	275	465	1
4701900	19	275	470	1
4702200	22	275	480	1
4702400	24	275	660	1
4702700	27	275	665	1
4703000	30	335	1200	1
4703200	32	335	1250	1
4703600	36	335	1300	1



420

DREHSTIFT TOMMY BAR

Spezial-Werkzeugstahl
schwarz

Special Carbon steel
black



Art.-No.	 mm	l-mm-l		
4205121	5 x 125	125	19	10
4206161	6 x 160	160	51	10
4208181	8 x 180	180	70	10
4210201	10 x 200	200	122	10
4212251	12 x 250	250	226	10
4214301	14 x 370	300	361	10
4216401	16 x 400	400	625	5
4218401	18 x 400	399	786	5
4220501	20 x 500	500	1210	1



430

DREHSTIFT, DIN 900 A TOMMY BAR, DIN 900 A

Spezial-Werkzeugstahl, gehärtet
schwarz

Special Carbon steel, hardened
black



Art.-No.	 mm	l-mm-l		
4305121	5 x 125	125	19	10
4306161	6 x 160	160	35	10
4308181	8 x 180	180	70	10
4310201	10 x 200	200	122	10
4312251	12 x 250	250	220	10
4314321	14 x 320	320	380	10
4316401	16 x 400	400	627	5
4318501	18 x 500	500	1000	1
4320631	20 x 630	630	1400	1



423

STUFEN-DREHSTIFT STEPPED TOMMY BAR

Chrom-Vanadium Stahl
verchromt

Chrome-Vanadium steel
chrome plated



Art.-No.	 mm	l-mm-l		
9218005	6 8 10 12	180	122	10
9200755	5 6 8 10 12	271	176	10



STIFTSCHLÜSSEL
KEY WRENCHES

03

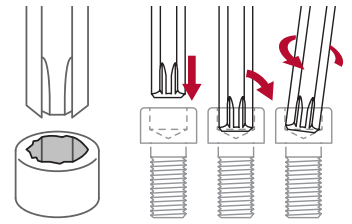

303 KH

GRIP-STIFTSCHLÜSSEL-SATZ GRIP HEXAGON KEY WRENCH SET



S2-Profi-Stahl, verchromt
mit patentiertem Fräskopf für beschädigte oder rundgedrehte
Schraubenköpfe

S2 Professional steel, chrome plated
with patented machined key for damaged or rounded
hex screws

Art.-No.	No.	mm	g	
3030013 H	303KH/9	1,5 2 2,5 3 4 5 6 8 10	438	5

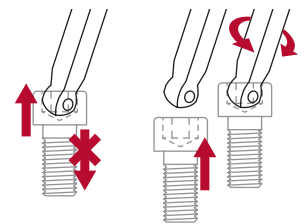

302 KH

SICHERHEITS-STIFTSCHLÜSSELSATZ SAFETY HEXAGON KEY WRENCH SET



S2-Profi-Stahl, verchromt
mit Federkugel* zum Fixieren der Schraube, für Arbeiten unter beengten
Verhältnissen
*ab Stiftschlüssel 3 mm

S2 Professional steel, chrome plated
with fixing ball* in round head to fix the screw, for working in constricted
space
*from Hexagon Key Wrench 3 mm

Art.-No.	No.	mm	g	
3020013 H	302KH/9	1,5 2 2,5 3 4 5 6 8 10	436	1



320

SECHSKANT-STIFTSCHLÜSSEL, DIN ISO 2936
HEXAGON KEY WRENCH, DIN ISO 2936

Chrom-Vanadium Stahl
vernickelt

Chrome-Vanadium steel
nickel plated



310

SECHSKANT-STIFTSCHLÜSSEL, DIN 6911
HEXAGON KEY WRENCH, DIN 6911

mit Zapfen
Chrom-Vanadium Stahl
vernickelt

with round hug
Chrome-Vanadium steel
nickel plated



Art.-No.	mm	mm	g	
3200156	1,5	45 x 14	1	100
3200206	2	50 x 16	2	100
3200256	2,5	56 x 18	3	100
3200306	3	63 x 20	4	100
3200356	3,5	68 x 22	8	100
3200406	4	70 x 25	10	100
3200456	4,5	75 x 27	15	100
3200506	5	80 x 28	17	100
3200556	5,5	85 x 30	22	100
3200606	6	90 x 32	30	100
3200706	7	95 x 34	41	50
3200806	8	100 x 36	58	50
3200906	9	105 x 38	77	20
3201006	10	112 x 40	100	20
3201106	11	119 x 42	127	20
3201206	12	125 x 45	166	20
3201306	13	132 x 50	201	10
3201406	14	140 x 55	260	10
3201506	15	140 x 55	312	10
3201606	16	160 x 60	400	10
3201706	17	160 x 60	438	10
3201806	18	170 x 65	510	5
3201906	19	180 x 70	618	5
3202006	20	180 x 70	650	5
3202106	21	200 x 80	860	5
3202206	22	200 x 80	950	1
3202406	24	224 x 90	1214	1
3202706	27	250 x 100	1740	1
3203006	30	280 x 112	2460	1
3203206	32	315 x 125	3080	1
3203606	36	335 x 140	4370	1

Art.-No.	mm	mm	g	
3100306	3	63 x 20	5	50
3100406	4	71 x 25	10	50
3100506	5	80 x 28	18	50
3100606	6	90 x 32	30	50
3100706	7	95 x 34	43	50
3100806	8	100 x 36	59	50
3101006	10	112 x 40	103	10
3101206	12	125 x 45	160	10
3101406	14	140 x 55	260	10
3101706	17	160 x 60	430	5
3101906	19	180 x 70	617	5
3102706	27	250 x 100	1740	5



330

SECHSKANT-STIFTSCHLÜSSEL, DIN ISO 2936 HEXAGON KEY WRENCH, DIN ISO 2936

extra lang
Chrom-Vanadium Stahl
vernickelt

extra long
Chrome-Vanadium steel
nickel plated

Art.-No.	mm	mm	g	
3300206	2	100 x 16	2	50
3300256	2,5	112 x 18	5	50
3300306	3	126 x 20	4	50
3300406	4	140 x 25	19	20
3300506	5	160 x 28	33	20
3300606	6	180 x 32	54	20
3300806	8	200 x 36	105	10
3301006	10	224 x 40	185	10
3301206	12	250 x 45	295	5
3301406	14	280 x 55	460	5
3301606	16	287 x 52	601	5
3301706	17	320 x 60	750	5
3301906	19	360 x 70	1100	5
3302206	22	400 x 80	1650	5
3302706	27	494 x 93	2960	1



328

SECHSKANT-STIFTSCHLÜSSEL, DIN ISO 2936 HEXAGON KEY WRENCH, DIN ISO 2936

mit Kugelkopf, extra lang
Chrom-Vanadium Stahl
vernickelt

with ball point, extra long
Chrome-Vanadium steel
nickel plated

Art.-No.	mm	mm	g	
9239696	1,5	90 x 13	4	50
9233336	2	100 x 16	4	20
9232996	2,5	112 x 18	6	20
9231176	3	126 x 20	9	20
9232016	4	140 x 25	19	20
9232026	5	160 x 28	33	20
9232036	6	180 x 32	54	20
9233006	7	190 x 34	80	10
9232046	8	200 x 36	105	10
9232056	10	224 x 40	185	10
9231186	12	250 x 45	295	10



345

SECHSKANT-STIFTSCHLÜSSEL MIT QUERGRIFF T-HANDLE HEXAGON KEY WRENCH

Chrom-Vanadium Stahl
vernickelt
Kunststoffquergriff mit Aufhängerloch



Chrome-Vanadium steel
nickel plated
plastic T-handle with hanging hole



Art.-No.	mm	mm	mm	g	
9208356	2	90	30 x 70	26	10
9208366	2,5	100	30 x 70	28	10
9212706	3	100	30 x 70	31	10
9208376	3	150	30 x 70	34	10
9212716	3	200	30 x 70	37	10
9212726	4	100	30 x 70	38	10
9208386	4	150	30 x 70	43	10
9212736	4	200	30 x 70	48	10
9212746	5	100	30 x 70	61	10
9213216	5	150	30 x 70	69	10
9208396	5	200	30 x 70	77	10
9212766	6	100	38 x 90	71	10

Art.-No.	mm	mm	mm	g	
9212776	6	150	38 x 90	83	10
9208406	6	200	38 x 90	95	10
9212786	8	100	38 x 90	118	10
9212796	8	150	38 x 90	118	10
9208416	8	200	38 x 90	139	5
9212806	10	100	46 x 110	157	10
9208426	10	200	45 x 110	225	5
9212816	12	100	46 x 110	198	10
9208436	12	200	46 x 110	296	10
9212826	12	250	46 x 110	346	5
9228696	13	200	46 x 110	300	5
9208446	14	300	46 x 110	478	5

348

QUERGRIFF-SCHRAUBENDREHER FÜR INNEN-TORX®-SCHRAUBEN T-HANDLE SCREWDRIVER FOR INSIDE TORX® SCREWS



Chrom-Vanadium Stahl
verchromt
Kunststoffquergriff
mit Aufhängeloch

Chrome-Vanadium steel
chrome plated
plastic T-handle
with hanging hole



Art.-No.		mm	mm	g	
34800603	TX6	100	30 x 70	31	10
34800703	TX7	100	30 x 70	31	10
34800803	TX8	100	30 x 70	31	10
34800903	TX9	100	30 x 70	31	10
34801003	TX10	100	30 x 70	31	10
34801503	TX15	100	30 x 70	31	10
34802003	TX20	125	38 x 90	54	10
34802503	TX25	125	38 x 90	58	10
34802703	TX27	125	38 x 90	68	10
34803003	TX30	125	38 x 90	74	10
34804003	TX40	125	38 x 90	75	10



340

KEILPROFIL-STIFTSCHLÜSSEL SPLINE KEYWRENCH

für RIBE Schrauben
Chrom-Vanadium Stahl
vernickelt

for RIBE screws
Chrome-Vanadium steel
nickel plated

Art.-No.		mm	g	
3400406	M4	63 x 20	15	10
3400506	M5	71 x 25	15	10
3400606	M6	80 x 28	25	10
3400806	M8	90 x 32	50	10
3401006	M10	90 x 32	86	10
3401206	M12	112 x 40	136	10
3401406	M14	125 x 45	213	10
3401606	M16	140 x 55	319	10



315

TORX®-STIFTSCHLÜSSEL TORX®-KEY WRENCH

Chrom-Vanadium Stahl | stahlgrau

Chrome-Vanadium steel | grey finished

Art.-No.		mm	g	
9216361	TX6	42 x 16	2	10
9216371	TX7	48 x 16	2	10
9216381	TX8	48 x 16	2	10
9216391	TX9	48 x 16	3	10
9216401	TX10	50 x 16	3	10
9216411	TX15	54 x 18	4	10
9216421	TX20	57 x 19	6	10
9216431	TX25	63 x 20	9	10
9216441	TX27	64 x 21	15	10
9216451	TX30	70 x 25	20	10
9216461	TX40	76 x 26	30	10
9216471	TX45	83 x 29	44	10
9216481	TX50	95 x 34	63	10
9216491	TX55	108 x 36	125	10
9216501	TX60	120 x 38	188	5

315 PKH

TORX®-STIFTSCHLÜSSEL-SATZ TORX® KEY WRENCH SET

Chrom-Vanadium Stahl
stahlgrau
im Handklapphalter aus Kunststoff

Chrome Vanadium steel
grey finished
in plastic clip



Art.-No.	No.			
9295997	M 315PKH/8	TX9 TX10 TX15 TX20 TX25 TX27 TX30 TX40	210	5

314 HKH

TAMPER TORX®-STIFTSCHLÜSSEL-SATZ TAMPER TORX® KEY WRENCH SET

Chrom-Vanadium Stahl
stahlgrau
im Handklapphalter aus Metall

Chrome-Vanadium steel
grey finished
in metal clip



Art.-No.	No.			
9248361	O 314HKH/8	TR9 TR10 TR15 TR20 TR25 TR27 TR30 TR40	254	5



320 PT

**SECHSKANT-STIFTSCHLÜSSEL-SATZ,
DIN ISO 2936**
HEXAGON KEY WRENCH SET,
DIN ISO 2936

Chrom-Vanadium Stahl
vernickelt
in Kunststofftasche

Chrome-Vanadium steel
nickel plated
in plastic wallet

Art.-No.	No.	mm		
9201286	G 320PT/8	2 2,5 3 4 5 6 8 10	242	5
9201296	I 320PT/10	2 2,5 3 4 5 6 8 10 12 14	655	5



320/1 PT

**SECHSKANT-STIFTSCHLÜSSEL-SATZ,
ÄHNLICH DIN ISO 2936**
HEXAGON KEY WRENCH SET,
SIMILAR TO DIN ISO 2936

Chrom-Vanadium Stahl
vernickelt
in Kunststofftasche

Chrome Vanadium steel
nickel plated
in plastic wallet

Art.-No.	No.	AF"		
9288126	J 320/1PT/8	5/64" 3/32" 1/8" 5/32" 3/16" 1/4" 5/16" 3/8"	250	1



320 HKH

SECHSKANT-STIFTSCHLÜSSEL-SATZ
HEXAGON KEY WRENCH SET

Chrom-Vanadium Stahl
vernickelt
im Handklapphalter aus Metall

Chrome-Vanadium steel
nickel plated
in metal clip

Art.-No.	No.	mm		
9206635	D 320HKH/07	2,5 3 4 5 6 8 10	332	5



320 PKH

SECHSKANT-STIFTSCHLÜSSEL-SATZ
HEXAGON KEY WRENCH SET

Chrom-Vanadium Stahl
vernickelt
im Handklapphalter aus Kunststoff

Chrome-Vanadium steel
nickel plated
in plastic clip

Art.-No.	No.	mm		
9295986	C 320PKH/6	2,5 3 4 5 6 8	172	1
9261696	F 320PKH/7	2,5 3 4 5 6 8 10	283	1





348 MS

QUERGRIF-SCHRAUBENDREHER-SATZ FÜR INNEN-TORX®-SCHRAUBEN

T-HANDLE SCREWDRIVER SET
FOR INSIDE TORX® SCREWS

Chrom-Vanadium Stahl
verchromt

Kunststoffquergriff mit Aufhängeloch
im Metallhalter

Chrome Vanadium steel
chrome plated
plastic T-handle with hanging hole
in metal holder

Art.-No.	No.			
9011060	L 348MS/8	TX8 TX9 TX10 TX15 TX20 TX25 TX30 TX40	880	1



345 MS

SECHSKANT-STIFTSCHLÜSSEL-SATZ MIT QUERGRIFF T-HANDLE HEXAGON KEY WRENCH SET

Chrom-Vanadium Stahl
vernickelt
Kunststoffquergriff mit Aufhängeloch
im Metallhalter

Chrome Vanadium steel
nickel plated
plastic T-handle with hanging hole
in metal holder

Art.-No.	No.			
9011080	G 345MS/8	2 2,5 3 4 5 6 8 10	1059	1



317 KH



TORX®-STIFTSCHLÜSSEL-SATZ MIT KUGELKOPF
TORX® KEY WRENCH SET WITH BALLPOINT

Chrom-Vanadium Stahl
verchromt mit schwarzer Spitze
im Kunststoffclip

Chrome-Vanadium steel
chrome plated with black tip
in plastic clip

Art.-No.	No.			
9242581	M 317KH/8	TX9 TX10 TX15 TX20 TX25 TX27 TX30 TX40	158	5



315 KH



TORX®-STIFTSCHLÜSSEL-SATZ
TORX® KEY WRENCH SET

Chrom-Vanadium Stahl
stahlgrau
im Kunststoffclip

Chrome Vanadium steel
grey finished
in plastic clip

Art.-No.	No.			
9289517	M 315KH/8	TX9 TX10 TX15 TX20 TX25 TX27 TX30 TX40	165	5



308 KH



TORX®-STIFTSCHLÜSSEL-SATZ, EXTRA LANG
TORX® KEY WRENCH SET, EXTRA LONG

Chrom-Vanadium Stahl
stahlgrau
im Kunststoffclip

Chrome Vanadium steel
grey finished
in plastic clip

Art.-No.	No.			
9296167	N 308KH/9	TX10 TX15 TX20 TX25 TX27 TX30 TX40 TX45 TX50	425	1



315 KSB



TORX®-STIFTSCHLÜSSEL-SATZ
TORX® KEY WRENCH SET

Chrom-Vanadium Stahl
stahlgrau
in Kunststoffschiebox
(ABS-schlagfest)

Chrome Vanadium steel
grey finished
in shatterproof plastic
sliding box

Art.-No.	No.			
9295887	M 315KSB/8	TX9 TX10 TX15 TX20 TX25 TX27 TX30 TX40	206	1



304 KH

SECHSKANT-STIFTSCHLÜSSEL-SATZ
HEXAGON KEY WRENCH SET

Chrom-Vanadium Stahl
vernickelt
im Kunststoffclip

Chrome Vanadium steel
nickel plated
in plastic clip

Art.-No.	No.	mm	g	Box
9296176	H 304KH/9	1,5 2 2,5 3 4 5 6 8 10	325	5



306 KH

SECHSKANT-STIFTSCHLÜSSEL-SATZ
HEXAGON KEY WRENCH SET

Chrom-Vanadium Stahl | verchromt
mit verkürztem Schenkel
100° gebogen | im Kunststoffclip

Chrome-Vanadium steel | chrome plated
with shortened leg
100° bent | in plastic clip

Art.-No.	No.	mm	g	Box
9296153	H 306KH/9	1,5 2 2,5 3 4 5 6 8 10	380	1



320 KH

SECHSKANT-STIFTSCHLÜSSEL-SATZ, DIN ISO 2936
HEXAGON KEY WRENCH SET, DIN ISO 2936

Chrom-Vanadium Stahl
vernickelt
im Kunststoffclip

Chrome-Vanadium steel
nickel plated
in plastic clip

Art.-No.	No.	mm	g	Box
9248226	H 320KH/9	1,5 2 2,5 3 4 5 6 8 10	243	5



320 PTR

SECHSKANT-STIFTSCHLÜSSEL-SATZ, DIN ISO 2936
HEXAGON KEY WRENCH SET, DIN ISO 2936

Chrom-Vanadium Stahl
vernickelt
am Ring

Chrome-Vanadium steel
nickel plated
on ring

Art.-No.	No.	mm	g	Box
9205896	A 320PTR/6	2 2,5 3 4 5 6	105	5



328 KH



SECHSKANT-STIFTSCHLÜSSEL-SATZ, DIN ISO 2936
HEXAGON KEY WRENCH SET, DIN ISO 2936

mit Kugelkopf, extra lang
Chrom-Vanadium Stahl | vernickelt
im Kunststoffclip

with ballpoint, extra long
Chrome-Vanadium steel | nickel plated
in plastic clip

Art.-No.	No.	mm		
9242616	H 328KH/9	1,5 2 2,5 3 4 5 6 8 10	428	5

329 KH



SECHSKANT-STIFTSCHLÜSSEL-SATZ, DIN ISO 2936
HEXAGON KEY WRENCH SET, DIN ISO 2936

mit Kugelkopf, extra lang,
mit Farbcodierung
Chrom-Vanadium Stahl | vernickelt
im Kunststoffclip

with ballpoint, extra long
colour coded
Chrome-Vanadium steel | nickel
plated in plastic clip

Art.-No.	No.	mm		
9295072	H 329KH/9	1,5 2 2,5 3 4 5 6 8 10	380	1



330 KH



SECHSKANT-STIFTSCHLÜSSEL-SATZ, DIN ISO 2936
HEXAGON KEY WRENCH SET, DIN ISO 2936

extra lang
Chrom-Vanadium Stahl | vernickelt
im Kunststoffclip

extra long
Chrome-Vanadium steel | nickel plated
in plastic clip

Art.-No.	No.	mm		
9242856	H 330KH/9	1,5 2 2,5 3 4 5 6 8 10	431	5

330/1 KH



**SECHSKANT-STIFTSCHLÜSSEL-SATZ,
ÄHNLICH DIN ISO 2936**
HEXAGON KEY WRENCH SET, SIMILAR TO DIN ISO 2936

Chrom-Vanadium Stahl | vernickelt
im Kunststoffclip

Chrome Vanadium steel | nickel plated
in plastic clip

Art.-No.	No.	ÄF"		
9291066	K 330/1KH/10	0,05 mm 1/16" 5/64" 3/32" 1/8" 5/32" 3/16" 7/32" 1/4" 5/16"	300	1



320 KSB



TORX®-STIFTSCHLÜSSEL-SATZ, DIN ISO 2936
TORX® KEY WRENCH SET, DIN ISO 2936

Chrom-Vanadium Stahl
vernickelt
in Kunststoffbox (ABS-schlagfest)

Chrome-Vanadium steel
nickel plated
in shatterproof plastic sliding box

Art.-No.	No.	mm	g	
9295916	H 320KSB/9	1,5 2 2,5 3 4 5 6 8 10	312	1

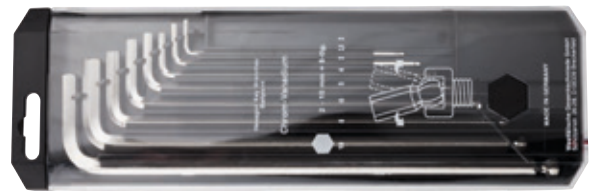
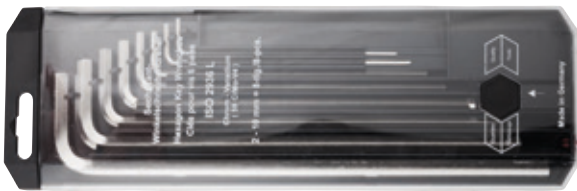

330 KSB



SECHSKANT-STIFTSCHLÜSSEL-SATZ, DIN ISO 2936
HEXAGON KEY WRENCH SET, DIN ISO 2936

extra lang
Chrom-Vanadium Stahl
vernickelt
in Kunststoffbox (ABS-schlagfest)

extra long
Chrome-Vanadium steel
nickel plated
in shatterproof plastic sliding box

Art.-No.	No.	mm	g	
9248246	G 330KSB/8	2 2,5 3 4 5 6 8 10	532	5

328 KSB



SECHSKANT-STIFTSCHLÜSSEL-SATZ, DIN ISO 2936
HEXAGON KEY WRENCH SET, DIN ISO 2936

mit Kugelkopf, extra lang
Chrom-Vanadium Stahl
vernickelt
in Kunststoffbox (ABS-schlagfest)

with ballpoint, extra long
Chrome-Vanadium steel
nickel plated
in shatterproof plastic sliding box

Art.-No.	No.	mm	g	
9248256	G 328KSB/8	2 2,5 3 4 5 6 8 10	530	5

Stiftschlüssel-Sätze im Überblick

Key Wrench Set Guide

	Art.-No.	No.	1,5	2	2,5	3	4	5	6	8	10	12	14	
	A	9216316	320PT/6		x	x	x	x	x					6
	C	9295986	320PHK/6			x	x	x	x	x				6
	F	9206635	320HKH/7			x	x	x	x	x	x			7
	F	9261696	320PKH/7			x	x	x	x	x	x			7
	G	9201286	320PT/8		x	x	x	x	x	x	x			8
	G	9248256	328KSB/8		x	x	x	x	x	x	x			8
	G	9248246	330KSB/8		x	x	x	x	x	x	x			8
	G	9011080	345MS/8		x	x	x	x	x	x	x			8
	H	3020013	302KH/9	x	x	x	x	x	x	x	x			9
	H	3030013	303KH/9	x	x	x	x	x	x	x	x			9
	H	9296176	304KH/9	x	x	x	x	x	x	x	x			9
	H	9248226	320KH/9	x	x	x	x	x	x	x	x			9
	H	9295916	320KSB/9	x	x	x	x	x	x	x	x			9
	H	9242616	328KH/9	x	x	x	x	x	x	x	x			9
	H	9295072	329KH/9	x	x	x	x	x	x	x	x			9
	H	9242856	330KH/9	x	x	x	x	x	x	x	x			9
	I	9201296	320PT/10		x	x	x	x	x	x	x	x	x	10

	Art.-No.	No.	0,05 mm	1/16"	5/64"	3/32"	1/8"	5/32"	3/16"	7/32"	1/4"	5/16"	3/8"	
	J	9288126	320/1PT/8			x	x	x	x		x	x	x	8
	K	9291066	330/1KH/10	x	x	x	x	x	x	x	x	x		10

	Art.-No.	No.	TX8	TX9	TX10	TX15	TX20	TX25	TX27	TX30	TX40	TX45	TX50	
	L	9011060	348MS/8	x	x	x	x	x		x	x			8
	M	9289517	315KH/8		x	x	x	x	x	x	x			8
	M	9295887	315KSB/8		x	x	x	x	x	x	x			8
	M	9295997	315PKH/8		x	x	x	x	x	x	x			8
	M	9242581	317KH/8		x	x	x	x	x	x	x			8
	N	9296167	308KH/9			x	x	x	x	x	x	x	x	9

	Art.-No.	No.	TR8	TR9	TR10	TR15	TR20	TR25	TR27	TR30	TR40	TR45	TR50	
	O	9248361	314HKH/8		x	x	x	x	x	x	x			8

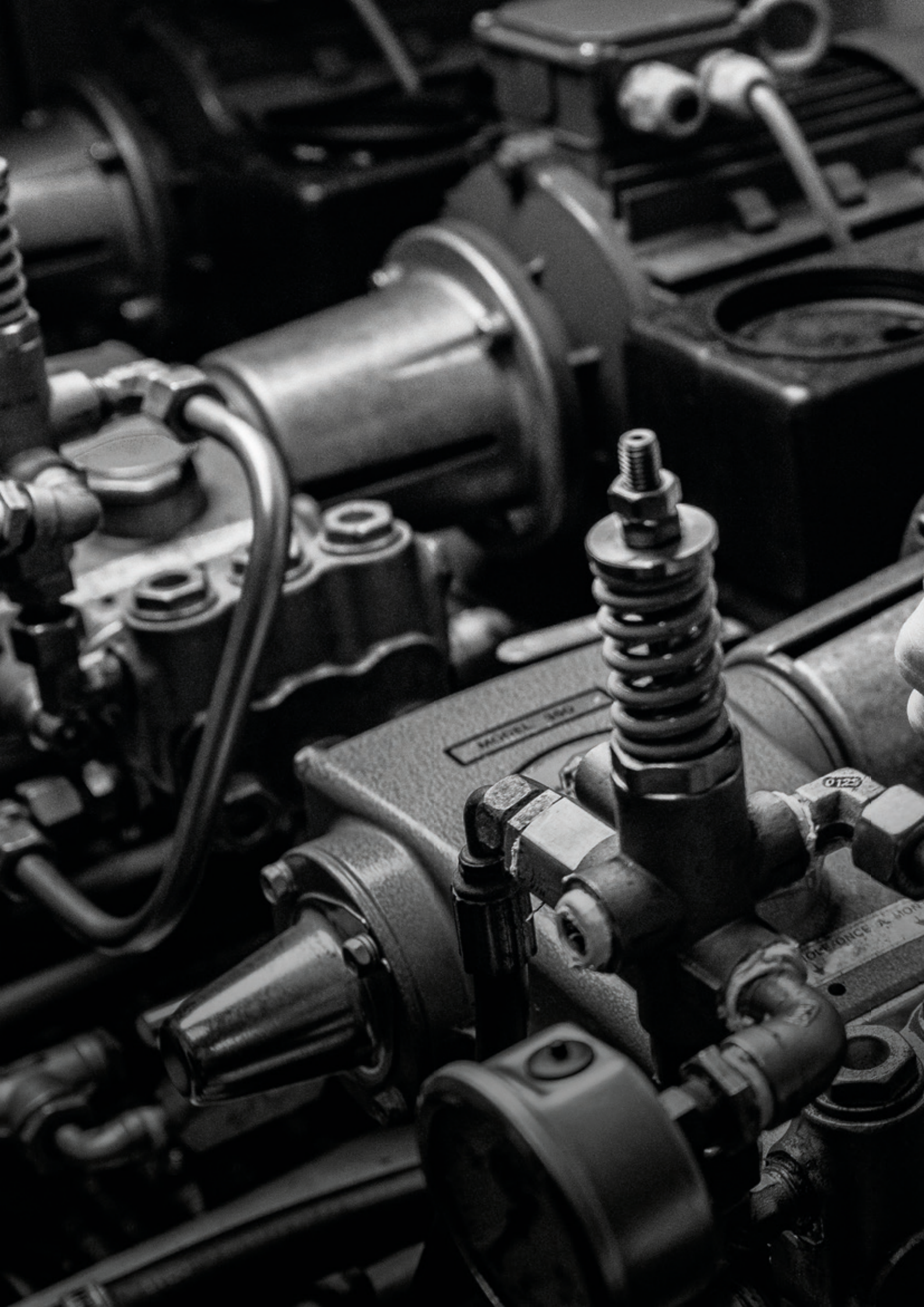

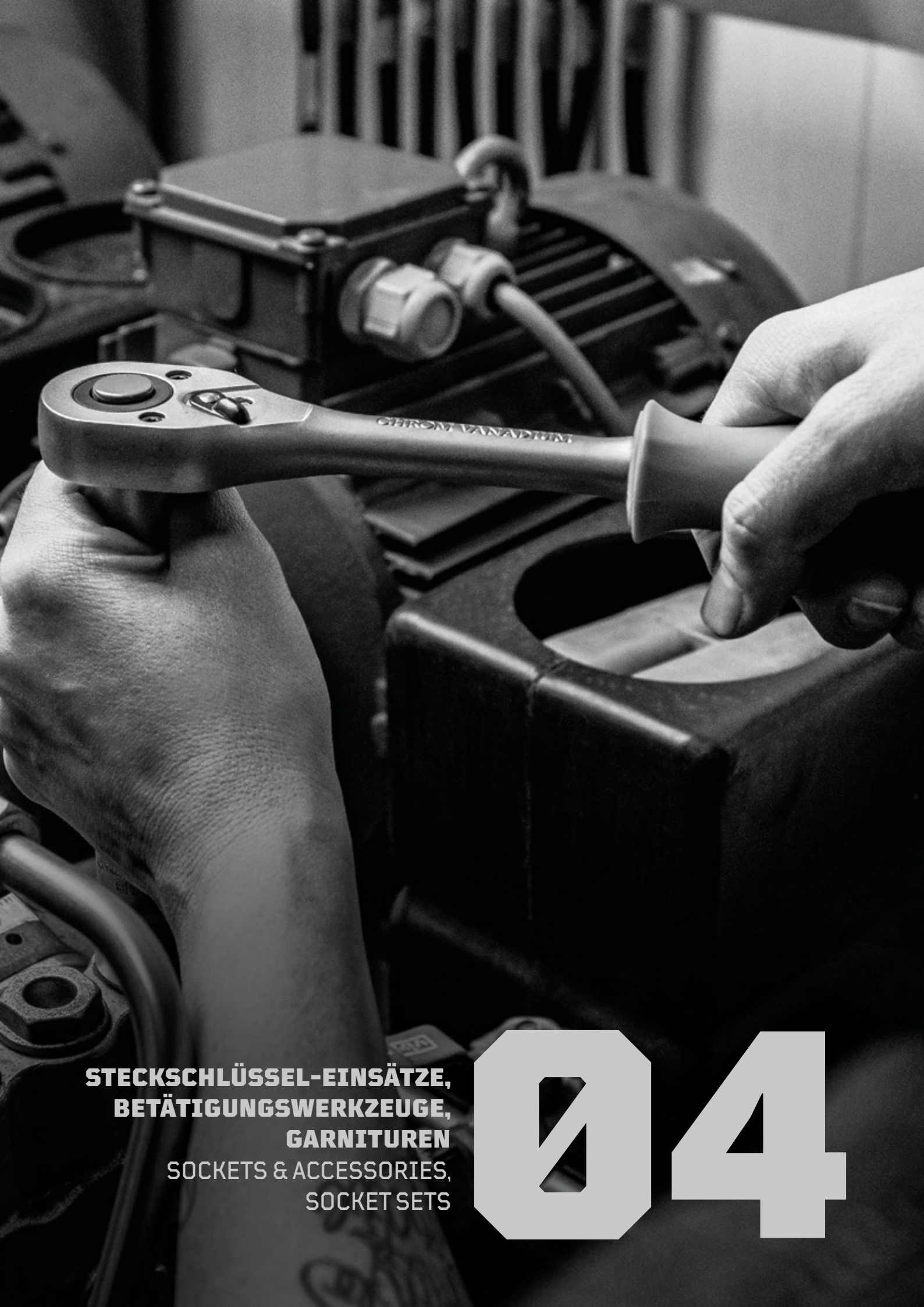

**STECKSCHLÜSSEL-EINSÄTZE,
BETÄTIGUNGSWERKZEUGE,
GARNITUREN**
SOCKETS & ACCESSORIES,
SOCKET SETS

04



500

6,3 1/4"

STECKSCHLÜSSEL-EINSATZ, 6-KANT, DIN 3124
SOCKET, 6-POINT, DIN 3124

DIN 3120 C, ISO 1174-1, ISO 2725-1
Chrom-Vanadium Stahl
verchromt

DIN 3120 C, ISO 1174-1, ISO 2725-1
Chrome-Vanadium steel
chrome plated

Art.-No.	Ø mm	l mm	g	
5000403	4	25	10	10
5000453	4,5	25	10	10
5000503	5	25	10	10
5000553	5,5	25	10	10
5000603	6	25	10	10
5000703	7	25	12	10
5000803	8	25	12	10
5000903	9	25	12	10
5001003	10	25	14	10
5001103	11	25	22	10
5001203	12	25	22	10
5001303	13	25	24	10
5001403	14	25	32	10

500/1

6,3 1/4"

STECKSCHLÜSSEL-EINSATZ, 6-KANT, DIN 3124
SOCKET, 6-POINT, DIN 3124

DIN 3120 C, ISO 1174-1, ISO 2725-1
Chrom-Vanadium Stahl
verchromt

DIN 3120 C, ISO 1174-1, ISO 2725-1
Chrome-Vanadium steel
chrome plated

Art.-No.	Ø AF"	l mm	g	
9271543	1/8"	25	9	10
9271553	5/32"	25	9	10
9271563	3/16"	25	10	10
9271573	7/32"	25	10	10
9271583	1/4"	25	10	10
9271593	9/32"	25	12	10
9271603	5/16"	25	11	10
9271613	11/32"	25	13	10
9271623	3/8"	25	13	10
9271633	7/16"	25	18	10
9271643	1/2"	25	23	10
9271653	9/16"	25	29	10



504

6,3 1/4"

MULTIGEAR STECKSCHLÜSSEL-EINSATZ
MULTIGEAR SOCKET

DIN 3120 C, DIN ISO 691,
DIN ISO 1711, ISO 1174-1,
ISO 2725-1
Chrom-Vanadium Stahl
verchromt

DIN 3120 C, DIN ISO 691,
DIN ISO 1711, ISO 1174-1,
ISO 2725-1
Chrome-Vanadium steel
chrome plated

Art.-No.	Ø mm	l mm	g	
9291893	8	24	12	10
9291903	10	24	14	10
9291913	13	25	19	10

524

6,3 1/4"

STECKSCHLÜSSEL-EINSATZ, 6-KANT, DIN 3124
SOCKET, 6-POINT, DIN 3124

DIN 3120 C, ISO 1174-1, ISO 2725-1
lange Ausführung
Chrom-Vanadium Stahl
verchromt

DIN 3120 C, ISO 1174-1, ISO 2725-1
long type
Chrome-Vanadium steel
chrome plated

Art.-No.	Ø mm	l mm	g	
9208903	8	50	24	10
9208913	10	50	32	10
9208923	11	50	36	10
9208933	13	50	48	10



527

PZ SCHRAUBENDREHER-EINSATZ PZ SCREWDRIVER SOCKET

DIN 3120 C, DIN ISO 8764-1,
ISO 1174-1
für PZ-Kreuzschlitzschrauben
Chrom-Vanadium Stahl
verchromt

DIN 3120 C, DIN ISO 8764-1,
ISO 1174-1
for PZ screws
Chrome-Vanadium steel
chrome plated



503

PH SCHRAUBENDREHER-EINSATZ PH SCREWDRIVER SOCKET

DIN 3120 C, DIN ISO 8764-1,
ISO 1174-1
für PH-Kreuzschlitzschrauben
Chrom-Vanadium Stahl
verchromt

DIN 3120 C, DIN ISO 8764-1,
ISO 1174-1
for PH screws
Chrome-Vanadium steel
chrome plated



Art.-No.		l-mm-l		
9209033	PZ1	32	14	10
9209043	PZ2	32	14	10
9209053	PZ3	32	14	10

Art.-No.		l-mm-l		
9208713	PH1	32	12	10
9208723	PH2	32	14	10
9208733	PH3	32	16	10



501

INNENSECHSKANT-SCHRAUBENDREHER-EINSATZ, DIN 7422 INSIDE HEXAGON SCREWDRIVER SOCKET, DIN 7422

DIN 3120 C, DIN ISO 8764-1,
ISO 1174-1
für Innensechskant-Schrauben
Chrom-Vanadium Stahl
verchromt

DIN 3120 C, DIN ISO 8764-1,
ISO 1174-1
for inside hexagon screws
Chrome-Vanadium steel
chrome plated



523

TX SCHRAUBENDREHER-EINSATZ TX SCREWDRIVER SOCKET

DIN 3120 C, ISO 1174-1
für Innen-TORX®-Schrauben
Chrom-Vanadium Stahl
verchromt

DIN 3120 C, ISO 1174-1
for inside TORX®-screws
Chrome-Vanadium steel
chrome plated



Art.-No.		l-mm-l		
9279783	2	32	15	10
9279793	2,5	32	15	10
9208633	3	32	16	10
9208643	4	32	17	10
9208653	5	32	17	10
9208663	6	32	17	10
9208673	8	32	18	10

Art.-No.			l-mm-l		
9208813	TX8	2,5	32	12	10
9208823	TX10	3,0-3,5	32	14	10
9208833	TX15	3,5-4	32	14	10
9208843	TX20	4-5	32	14	10
9208853	TX25	4,5-5	32	14	10
9208863	TX27	4,5-6	32	14	10
9208873	TX30	6-7	32	14	10
9208883	TX40	7-8	32	14	10



502

6,3 1/4" ⊖

SCHRAUBENDREHER-EINSATZ SCREWDRIVER SOCKET

DIN 3120 C, DIN 5264, DIN ISO 2380-1, ISO 1174-1 für Schlitzschrauben
Chrom-Vanadium Stahl | verchromt

DIN 3120 C, DIN 5264, DIN ISO 2380-1, ISO 1174-1 for slotted screws
Chrome-Vanadium steel | chrome plated

Art.-No.	mm	mm	g	
9208683	4	32	13	10
9208693	5,5	32	14	10
9209023	6,5	32	14	10



1351

6,3 1/4" ⊕

BIT-ADAPTER, DIN 3126 BIT ADAPTOR, DIN 3126

DIN 3120 C, DIN 3126, ISO 1173, ISO 1174-1 mit Haltefeder für Bitaufnahme
Chrom-Vanadium Stahl | verchromt

DIN 3120 C, DIN 3126, ISO 1173, ISO 1174-1 with retaining spring for bit use
Chrome-Vanadium steel | chrome plated

Art.-No.	mm	mm	mm	g	
9224153	1/4"	1/4"	25	18	10



507

6,3 1/4" ⊕ ⊕

VERLÄNGERUNG, DIN 3123 B EXTENSION BAR, DIN 3123 B

DIN 3120 A/C, ISO 1174-1, ISO 3316 Chrom-Vanadium Stahl verchromt

DIN 3120 A/C, ISO 1174-1, ISO 3316 Chrome-Vanadium steel chrome plated

Art.-No.	mm	g	
9208783	55	22	10
9228713	75	34	10
9208793	100	44	10
9226143	150	65	10



529

6,3 1/4" ⊕ ⊕

FLEXIBLE VERLÄNGERUNG FLEXIBLE EXTENSION

DIN 3120 A/C, ISO 1174-1 Chrom-Vanadium Stahl verchromt

DIN 3120 A/C, ISO 1174-1 Chrome-Vanadium steel chrome plated

Art.-No.	mm	g	
5290013	150	42	10



506

6,3 1/4" ⊕ ⊕

GRIFF MIT GLEITSTÜCK, DIN 3122 A SLIDING T-HANDLE, DIN 3122 A

DIN 3120 A/C, ISO 1174-1, ISO 3315 Chrom-Vanadium Stahl verchromt

DIN 3120 A/C, ISO 1174-1, ISO 3315 Chrome-Vanadium steel chrome plated

Art.-No.	mm	g	
9208773	115	43	10



509

6,3 1/4" ⊕ ⊕

KARDAN-GELENK, DIN 3123 C UNIVERSAL JOINT, DIN 3123 C

DIN 3120 A/C, ISO 1174-1, ISO 3316 Chrom-Vanadium Stahl verchromt

DIN 3120 A/C, ISO 1174-1, ISO 3316 Chrome-Vanadium steel chrome plated

Art.-No.	mm	g	
9208803	40	26	10



519

ÜBERGANGSTEIL, DIN 3123 A
ADAPTOR, DIN 3123 A



DIN 3120 A/C, ISO 1174-1, ISO 3316
1/4" innen, 3/8" außen
Chrom-Vanadium Stahl
verchromt

DIN 3120 A/C, ISO 1174-1, ISO 3316
1/4" female, 3/8" male
Chrome-Vanadium steel
chrome plated

Art.-No.	l-mm-l		
9223673	25	24	10



548

MASCHINEN-ADAPTER, DIN 3126
MACHINERY ADAPTOR, DIN 3126



DIN 3121, DIN 3126, ISO 1174-1, ISO 3317
Chrom-Vanadium Stahl | stahlgrau
1/4" außen, 1/4" außen

DIN 3121, DIN 3126, ISO 1174-1, ISO 3317
Chrome-Vanadium steel | grey finish
1/4" male, 1/4" male

Art.-No.	l-mm-l		
54814147	65	21	10



344 SB

MINI-ADAPTER SET
MINI ADAPTOR SET



DIN 3120
Chrom-Vanadium Stahl
schwarz

DIN 3120
Chrome-Vanadium steel
black

Art.-No.			
3440000		249	10



377

MASCHINEN-ADAPTER SET
MACHINERY ADAPTOR SET



DIN 3121, DIN 3126, ISO 1174-1, ISO 3317
Chrom-Vanadium Stahl | stahlgrau
1/4" | 3/8" | 1/2" außen, 1/4" außen

DIN 3121, DIN 3126, ISO 1174-1, ISO 3317
Chrome-Vanadium steel | grey finish
1/4" | 3/8" | 1/2" male, 1/4" male

Art.-No.			
9011147		108	1



572

GELENKGRIFF, DIN 3122 F
FLEXIBLE HANDLE, DIN 3122 F

DIN 3120 A, ISO 1174-1, ISO 3315
Chrom-Vanadium Stahl
verchromt
2-Komponentenheft

DIN 3120 A, ISO 1174-1, ISO 3315
Chrome-Vanadium steel
chrome plated
two component handle



Art.-No.	l-mm-l		
5720003	165	104	5

505

STECKGRIFF, DIN 3122 E
SPINNER HANDLE, DIN 3122 E

DIN 3120 A, ISO 1174-1
Chrom-Vanadium Stahl
verchromt
2-Komponentenheft

DIN 3120 A, ISO 1174-1
Chrome-Vanadium steel
chrome plated
two component handle



Art.-No.	l-mm-l		
9208763	150	60	10



5504

UMSCHALTKNARRE, 43 ZÄHNE, DIN 3122 D
REVERSIBLE RATCHET, 43 TEETH, DIN 3122 D

DIN 3120 A, ISO 1174-1, ISO 3315
Chrom-Vanadium Stahl
verchromt
2-Komponentenheft

DIN 3120 A, ISO 1174-1, ISO 3315
Chrome-Vanadium steel
chrome plated
two component handle



Art.-No.		l-mm-l		
9291683	43	165	140	10

5012

HEBELUMSCHALTKNARRE, 72 ZÄHNE, GEBOGENER SCHAFT, DIN 3122 D
REVERSIBLE RATCHET, LEVER TYPE, 72 TEETH, CURVED SHAFT, DIN 3122 D

DIN 3120 A, ISO 1174-1, ISO 3315
Chrom-Vanadium Stahl
verchromt
2-Komponentenheft

DIN 3120 A, ISO 1174-1, ISO 3315
Chrome-Vanadium steel
chrome plated
two component handle



Art.-No.		l-mm-l		
5012003	72	150	91	10



5013

6,3 1/4" 

HEBELUMSCHALTKNARRE, 72 ZÄHNE, GERADER SCHAFT, DIN 3122 D
REVERSIBLE RATCHET, LEVER TYPE, 72 TEETH, STRAIGHT SHAFT, DIN 3122 D

DIN 3120 A, ISO 1174-1, ISO 3315 Chrom-Vanadium Stahl verchromt 2-Komponentenheft
DIN 3120 A, ISO 1174-1, ISO 3315 Chrome-Vanadium steel chrome plated two component handle

Art.-No.		l-mm-l		
9291713	72	165	149	10



511

6,3 1/4" 

Gelenk-Teleskop-Hebelumschaltknarre, 72 Zähne, DIN 3122 D
JOINT EXTENDABLE REVERSIBLE RATCHET, 72 TEETH, DIN 3122 D

DIN 3120 A, ISO 1174-1, ISO 3315 Chrom-Vanadium Stahl verchromt mit Feststellfunktion 2-Komponentenheft

DIN 3120 A, ISO 1174-1, ISO 3315 Chrome-Vanadium steel chrome plated with caps lock two component handle

Art.-No.		l-mm-l		
5110003	72	175-225	230	10



Voller Dreh für Problemfälle: Full turn for problem cases:

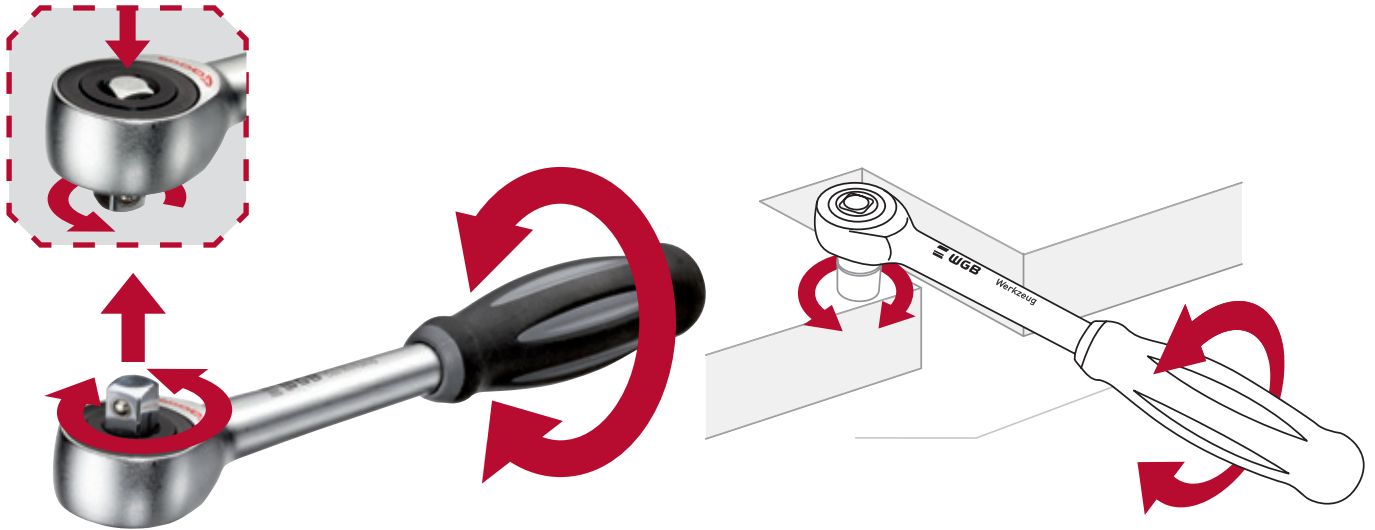

528

ROTATIONSKNARRE, 60 ZÄHNE, DIN 3122 D
REVERSIBLE RATCHET, TURNABLE, 60 TEETH, DIN 3122 D

DIN 3120 A, ISO 1174-1, ISO 3315

Chrom-Vanadium Stahl

verchromt

drehbares 2-Komponentenheft

- durch Drehen des Handgriffes um die eigene Achse (egal in welche Richtung) dreht sich der Antriebsvierkant in die gleiche Richtung und schraubt in den unzugänglichsten Positionen
- zusätzlich wie jede herkömmliche Knarre verwendbar
- ermöglicht das Arbeiten in allen Lagen
- hilft auch dort, wo herkömmliche Schraubwerkzeuge nicht anwendbar sind

6,3 1/4" 

DIN 3120 A, ISO 1174-1, ISO 3315

Chrome-Vanadium steel

chrome plated

turnable two component handle

- by turning the handle around its own axis (no matter which direction) the square drive turns in the same direction and screws in the most inaccessible positions
- can also be used like any conventional ratchet
- enables working in all positions
- also helps where conventional screwing tools cannot be used



Art.-No.



l-mm-l



5280003

60

180

200

10



5040

STECKSCHLÜSSEL-GARNITUR SOCKET SET

Chrom-Vanadium Stahl
verchromt
im Stahlblechkasten
36-tlg.

- 1/4" Steckschlüssel-Einsatz, 6-kant
4 | 4,5 | 5 | 5,5 | 6 | 6,5 | 7 | 8 | 9 | 10 | 11 | 12 | 13 mm
- 1/4" PH Schraubendreher-Einsatz PH1 | PH2
- 1/4" Schraubendreher-Einsatz 4 | 5,5 mm
- 1/4" Innensechskant-Schraubendreher-Einsatz 3 | 4 | 5 | 6 mm
- 1/4" TR Schraubendreher-Einsatz TR20 | TR25 | TR27 | TR30
- 1/4" Kardan-Gelenk
- 1/4" Verlängerung 50 | 100 mm
- 1/4" Adapter-Gleitstück 3/8" x 1/4"
- 1/4" Steckgriff mit 1/4" Antriebsvierkant
- 1/4" Umschaltknarre, 43 Zähne 140 mm
- Sechskant-Stiftschlüssel 1,25 | 1,5 | 2 | 2,5 | 3 mm



Chrome-Vanadium steel
chrome plated
in metal box
36 pcs.

- 1/4" Socket, 6-point
4 | 4,5 | 5 | 5,5 | 6 | 6,5 | 7 | 8 | 9 | 10 | 11 | 12 | 13 mm
- 1/4" PH Screwdriver Socket PH1 | PH2
- 1/4" Screwdriver Socket 4 | 5,5 mm
- 1/4" Inside Hexagon Screwdriver Socket 3 | 4 | 5 | 6 mm
- 1/4" TR Screwdriver Socket TR20 | TR25 | TR27 | TR30
- 1/4" Universal Joint
- 1/4" Extension Bar 50 | 100 mm
- 1/4" Sliding Adaptor 3/8"x1/4"
- 1/4" Spinner Handle with 1/4" Square Coupler
- 1/4" Reversible Ratchet, 43 teeth 140 mm
- Hexagon Key Wrench 1.25 | 1.5 | 2 | 2.5 | 3 mm

Art.-No.	H x B x T (mm) H x W x L (mm)		
9291603	38 x 242 x 117	1258	1

Einzelteile entsprechen der DIN | parts according to DIN



2014

10 3/8"

STECKSCHLÜSSEL-EINSATZ, 12-KANT, DIN 3124
SOCKET, 12-POINT, DIN 3124

DIN 2725-1, DIN 3120 C,
ISO 1174-1

Chrom-Vanadium Stahl
verchromt

DIN 2725-1, DIN 3120 C,
ISO 1174-1

Chrome-Vanadium steel
chrome plated

Art.-No.	mm	l-mm-l		
9225773	6	28	20	10
9225783	7	28	21	10
9225793	8	28	21	10
9225803	9	28	22	10
9225813	10	28	23	10
9225823	11	28	25	10
9248933	12	28	24	10
9225833	13	28	27	10
9225843	14	28	29	10
9225853	15	28	37	10
9248943	16	28	34	10
9225863	17	28	44	10
9248953	18	30	58	10
9225873	19	30	58	10
9248963	20	30	65	10
9248973	21	30	63	10
9248983	22	30	78	10

2014/1

10 3/8"

STECKSCHLÜSSEL-EINSATZ, 12-KANT, DIN 3124
SOCKET, 12-POINT, DIN 3124

DIN 2725-1, DIN 3120 C,
ISO 1174-1

Chrom-Vanadium Stahl
verchromt

DIN 2725-1, DIN 3120 C,
ISO 1174-1

Chrome-Vanadium steel
chrome plated

Art.-No.	ÄF"	l-mm-l		
9265143	1/4"	28	21	10
9265163	5/16"	28	22	10
9265403	3/8"	28	23	10
9269323	9/32"	28	23	10
9265413	7/16"	28	23	10
9259843	1/2"	28	25	10
9265423	9/16"	28	26	10
9265433	19/32"	28	32	10
9265443	5/8"	28	34	10
92621323	21/32"	30	42	10
9265453	11/16"	30	44	10
9265463	3/4"	30	56	10
92625323	25/32"	30	58	10
92613163	13/16"	30	67	10
9265473	7/8"	30	73	10



2095

10 3/8"

ZÜNDKERZEN-EINSATZ
SPARK PLUG SOCKET

DIN 3120 C, ISO 1174-1

Chrom-Vanadium Stahl
verchromt
mit Gummihalter

DIN 3120 C, ISO 1174-1

Chrome-Vanadium steel
chrome plated
with rubber insert

Art.-No.	mm	l-mm-l		
9243583	16	64	93	10
9243593	18	80	188	10
9243603	21	80	188	10

2016

10 3/8"

E-TX SCHRAUBENDREHER-EINSATZ
E-TX SCREWDRIVER SOCKET

DIN 3120 C, ISO 1174-1

Chrom-Vanadium-Stahl
verchromt

DIN 3120 C, ISO 1174-1

Chrome Vanadium steel
chrome plated

Art.-No.		l-mm-l		
20160803	E8	28	23	10
20161003	E10	28	26	10
20161103	E11	28	26	10
20161203	E12	29	26	10
20161403	E14	27	31	10



2100

SCHRAUBENDREHER-EINSATZ SCREWDRIVER SOCKET

DIN 3120 C, DIN 5264,
DIN ISO 2380-1, ISO 1174-1
für Schlitzschrauben
Chrom-Vanadium Stahl
verchromt

DIN 3120 C, DIN 5264,
DIN ISO 2380-1, ISO 1174-1
for slotted screws
Chrome-Vanadium steel
chrome plated



2070

PH SCHRAUBENDREHER-EINSATZ PH SCREWDRIVER SOCKET

DIN 3120 C, DIN ISO 8764-1,
ISO 1174-1
für PH Kreuzschlitzschrauben
Chrom-Vanadium Stahl
verchromt

DIN 3120 C, DIN ISO 8764-1,
ISO 1174-1
for PH screws
Chrome-Vanadium steel
chrome plated



Art.-No.	mm	l-mm-l	g	
9228883	8	45	53	10
9228893	10	45	54	10

Art.-No.		l-mm-l	g	
9228853	PH2	52	55	10
9228863	PH3	52	55	10
9228873	PH4	52	56	10



2051

INNENSECHSKANT-SCHRAUBENDREHER-EINSATZ, DIN 7422 INSIDE HEXAGON SCREWDRIVER SOCKET, DIN 7422

DIN 3120 C, DIN ISO 8764-1,
ISO 1174-1
für Innensechskant-Schrauben
Chrom-Vanadium Stahl
verchromt

DIN 3120 C, DIN ISO 8764-1,
ISO 1174-1
for inside hexagon screws
Chrome-Vanadium steel
chrome plated



2320

TX SCHRAUBENDREHER-EINSATZ TX SCREWDRIVER SOCKET

DIN 3120 C, ISO 1174-1
für Innen-TORX®-Schrauben
Chrom-Vanadium Stahl
verchromt

DIN 3120 C, ISO 1174-1
for inside TORX®-screws
Chrome-Vanadium steel
chrome plated



Art.-No.		l-mm-l	g	
9248993	4	48	34	10
9225993	5	48	34	10
9226003	6	48	34	10
9249003	7	48	38	10
9226013	8	48	39	10

Art.-No.		M	l-mm-l	g	
9243523	TX10	3	46	33	10
9243423	TX15	3,5-4	46	33	10
9243433	TX20	4-5	46	33	10
9243443	TX25	4,5-5	46	33	10
9243453	TX27	4,5-6	46	33	10
9243463	TX30	6-7	46	34	10
9243473	TX40	7-8	46	34	10
9243483	TX45	8-10	46	37	10
9243493	TX50	10	47	38	10
9296413	TX55	12	48	45	10



2522

BIT-ADAPTER, DIN 3126
BIT ADAPTOR, DIN 3126

DIN 3120 C, DIN 3126,
ISO 1173, ISO 1174-1
mit Haltefeder für Bitaufnahme
Chrom-Vanadium Stahl
verchromt

DIN 3120 C, DIN 3126,
ISO 1173, ISO 1174-1
with retaining spring for bit use
Chrom-Vanadium steel
chrome plated



2115

VERLÄNGERUNG, DIN 3123 B
EXTENSION BAR, DIN 3123 B

DIN 3120 A/C, ISO 1174-1,
ISO 3316
Chrom-Vanadium Stahl
verchromt

DIN 3120 A/C, ISO 1174-1,
ISO 3316
Chrom-Vanadium steel
chrome plated



Art.-No.			l-mm-l		
9259283	3/8"	1/4"	30	35	10
9259293	3/8"	5/16"	30	39	10

Art.-No.	l-mm-l		
9224033	50	53	10
9225923	75	75	10
9224053	125	122	10
9224043	150	143	10
9224063	250	235	10



2165

GRIFF MIT GLEITSTÜCK, DIN 3122 A
SLIDING T-HANDLE, DIN 3122 A

DIN 3120 A/C, ISO 1174-1,
ISO 3316
Chrom-Vanadium Stahl
verchromt

DIN 3120 A/C, ISO 1174-1,
ISO 3316
Chrom-Vanadium steel
chrome plated



2110

KARDAN-GELENK, DIN 3123 C
UNIVERSAL JOINT, DIN 3123 C

DIN 3120 A/C, ISO 1174-1,
ISO 3316
Chrom-Vanadium Stahl
verchromt

DIN 3120 A/C, ISO 1174-1,
ISO 3316
Chrom-Vanadium steel
chrome plated



Art.-No.	l-mm-l		
9226913	200	160	10

Art.-No.	l-mm-l		
9224073	58	66	10



2215

ÜBERGANGSTEIL, DIN 3123 A
ADAPTOR, DIN 3123 A



DIN 3120 A/C, ISO 1174-1,
ISO 3316
3/8" innen, 1/2" außen
Chrom-Vanadium Stahl
verchromt

DIN 3120 A/C, ISO 1174-1,
ISO 3316
3/8" female, 1/2" male
Chrome-Vanadium steel
chrome plated

Art.-No.	l-mm-l		
9227923	36	51	10
9280713	44	50	10

1220

ÜBERGANGSTEIL, DIN 3123 A
ADAPTOR, DIN 3123 A



DIN 3120 A/C, ISO 1174-1,
ISO 3316
3/8" innen, 1/4" außen
Chrom-Vanadium Stahl
verchromt

DIN 3120 A/C, ISO 1174-1,
ISO 3316
3/8" female, 1/4" male
Chrome-Vanadium steel
chrome plated

Art.-No.	l-mm-l		
9226043	27	21	10



2322

VERBINDUNGSVIEKANT, DIN 3122
SQUARE COUPLER, DIN 3122



DIN 3120 A, ISO 1174-1
Chrom-Vanadium Stahl
verchromt

DIN 3120 A, ISO 1174-1
Chrome-Vanadium steel
chrome plated

Art.-No.	l-mm-l		
2322003	24	14	10



2346

MASCHINEN-ADAPTER, DIN 3126
MACHINERY ADAPTOR, DIN 3126

DIN 3121, DIN 3126,
ISO 1174-1, ISO 3317
Chrom-Vanadium Stahl
stahlgrau
3/8" außen, 1/4" außen

DIN 3121, DIN 3126,
ISO 1174-1, ISO 3317
Chrome-Vanadium steel
grey finish
3/8" male, 1/4" male

Art.-No.	l-mm-l		
234638147	65	28	10



377

MASCHINEN-ADAPTER SET
MACHINERY ADAPTOR SET

DIN 3121, DIN 3126,
ISO 1174-1, ISO 3317
Chrom-Vanadium Stahl
stahlgrau
1/4" | 3/8" | 1/2" außen, 1/4" außen

DIN 3121, DIN 3126,
ISO 1174-1, ISO 3317
Chrome-Vanadium steel
grey finish
1/4" | 3/8" | 1/2" male, 1/4" male

Art.-No.			
9011147	1/4" 3/8" 1/2"	108	1



2321

Gelenkgriff, DIN 3122 F
FLEXIBLE HANDLE, DIN 3122 F

DIN 3120 A, ISO 1174-1, ISO 3315
Chrom-Vanadium Stahl
verchromt
2-Komponentenheft

DIN 3120 A, ISO 1174-1, ISO 3315
Chrome-Vanadium steel
chrome plated
two component handle

Art.-No.	l-mm-l		
2321003	225	208	10



2270

Umschaltknarre, 41 Zähne, DIN 3122 D
REVERSIBLE RATCHET, 41 TEETH, DIN 3122 D

DIN 3120 A, ISO 1174-1, ISO 3315
Chrom-Vanadium Stahl
verchromt
2-Komponentenheft

DIN 3120 A, ISO 1174-1, ISO 3315
Chrome-Vanadium steel
chrome plated
two component handle

Art.-No.		l-mm-l		
9291693	41	205	308	10



2356

10 3/8"

HEBELUMSCHALTKNARRE, 72 ZÄHNE, GEBOGENER SCHAFT, DIN 3122 D
REVERSIBLE RATCHET, LEVER TYPE, 72 TEETH, CURVED SHAFT, DIN 3122 D

DIN 3120 A, ISO 1174-1, ISO 3315 Chrom-Vanadium Stahl verchromt 2-Komponentenheft
DIN 3120 A, ISO 1174-1, ISO 3315 Chrome-Vanadium steel chrome plated two component handle

Art.-No.		l-mm-l		
2356003	72	200	255	10

2357

10 3/8"

HEBELUMSCHALTKNARRE, 72 ZÄHNE, GERADER SCHAFT, DIN 3122 D
REVERSIBLE RATCHET, LEVER TYPE, 72 TEETH, STRAIGHT SHAFT, DIN 3122 D

DIN 3120 A, ISO 1174-1, ISO 3315 Chrom-Vanadium Stahl verchromt 2-Komponentenheft
DIN 3120 A, ISO 1174-1, ISO 3315 Chrome-Vanadium steel chrome plated two component handle

Art.-No.		l-mm-l		
9291723	72	230	321	10

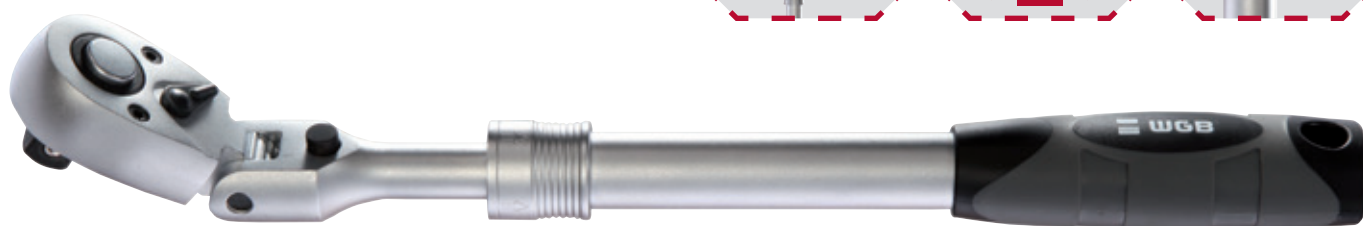

2511

10 3/8"

Gelenk-Teleskop-Hebelumschaltknarre, 72 Zähne, DIN 3122 D
JOINT EXTENDABLE REVERSIBLE RATCHET, 72 TEETH, DIN 3122 D

DIN 3120 A, ISO 1174-1, ISO 3315 Chrom-Vanadium Stahl verchromt 2-Komponentenheft
DIN 3120 A, ISO 1174-1, ISO 3315 Chrome-Vanadium steel chrome plated two component handle

Art.-No.		l-mm-l		
2511003	72	250-350	540	10

Voller Dreh für Problemfälle: Full turn for problem cases:

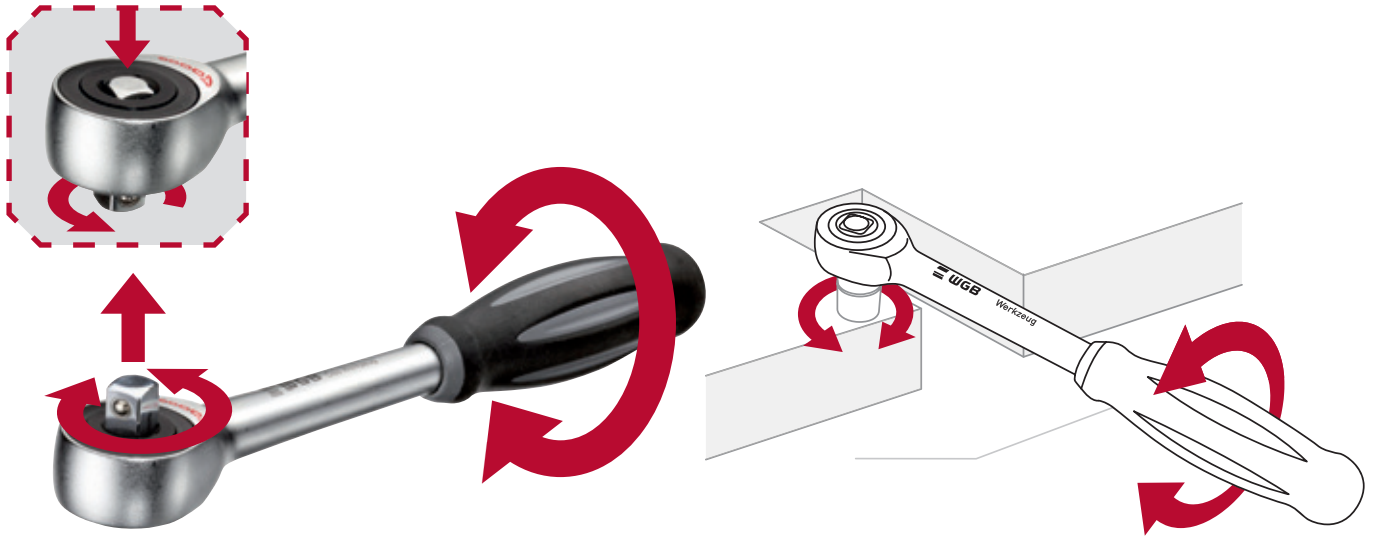

2528

ROTATIONSKNARRE, 60 ZÄHNE, DIN 3122 D
REVERSIBLE RATCHET, TURNABLE, 60 TEETH, DIN 3122 D

DIN 3120 A, ISO 1174-1, ISO 3315

Chrom-Vanadium Stahl

verchromt

drehbares 2-Komponentenheft

- durch Drehen des Handgriffes um die eigene Achse (egal in welche Richtung) dreht sich der Antriebsvierkant in die gleiche Richtung und schraubt in den unzugänglichsten Positionen
- zusätzlich wie jede herkömmliche Knarre verwendbar
- ermöglicht das Arbeiten in allen Lagen
- hilft auch dort, wo herkömmliche Schraubwerkzeuge nicht anwendbar sind

10 3/8" 

DIN 3120 A, ISO 1174-1, ISO 3315



Chrome-Vanadium steel

chrome plated

turnable two component handle

- by turning the handle around its own axis (no matter which direction) the square drive turns in the same direction and screws in the most inaccessible positions
- can also be used like any conventional ratchet
- enables working in all positions
- also helps where conventional screwing tools cannot be used



Art.-No.		l-mm-l		
2528003	60	240	400	10



2490

STECKSCHLÜSSEL-GARNITUR SOCKET SET



Chrom-Vanadium Stahl, verchromt
55-tlg.
im Stahlblechkasten
in säure- und schmierstoffbeständiger Schaumstoffeinlage

- 3/8" Hebelumschaltknarre, 72 Zähne
- 3/8" Steckschlüssel-Einsatz, 6-kant 6 | 7 | 8 | 10 | 11 | 12 | 13 | 14 | 15 | 16 | 17 | 18 | 19 | 21 | 22 | 24 mm
- 3/8" Verlängerung 75 | 150 mm
- 3/8" Gleitstück 1/2" innen x 3/8" außen
- 3/8" Kardan-Gelenk
- 3/8" Zündkerzen-Einsatz 16 | 18 | 21 mm
- 3/8" Innensechskant-Schraubendreher-Einsatz 3 | 4 | 5 | 6 | 8 | 10 mm
- 3/8" PZ Schraubendreher-Einsatz PZ1 | PZ2 | PZ3
- 3/8" PH Schraubendreher-Einsatz PH1 | PH2 | PH3
- 3/8" Schraubendreher-Einsatz 4 | 5,5 | 7 mm
- 3/8" TX Schraubendreher-Einsatz TX10 | TX15 | TX20 | TX25 | TX27 | TX30 | TX40 | TX45
- Sechskant-Stiftschlüssel-Satz 1,5 | 2 | 2,5 | 3 | 4 | 5 | 5,5 | 6 mm



Chrome-Vanadium steel, chrome plated
55 pcs.
in metal box
in acid and lubricant resistant foam insert

- 3/8" Reversible Ratchet, 72 teeth 320 mm
- 3/8" Socket, 6-point 6 | 7 | 8 | 10 | 11 | 12 | 13 | 14 | 15 | 16 | 17 | 18 | 19 | 21 | 22 | 24 mm
- 3/8" Extension Bar 75 | 150 mm
- 3/8" Sliding Adaptor 1/2" female x 3/8" male
- 3/8" Universal Joint
- 3/8" Spark Plug Socket, 6-point 16 | 18 | 21 mm
- 3/8" Inside Hexagon Screwdriver Socket 3 | 4 | 5 | 6 | 8 | 10 mm
- 3/8" PZ Screwdriver Socket PZ1 | PZ2 | PZ3
- 3/8" PH Screwdriver Socket PH1 | PH2 | PH3
- 3/8" Screwdriver Socket 4 | 5,5 | 7 mm
- 3/8" TX Screwdriver Socket TX10 | TX15 | TX20 | TX25 | TX27 | TX30 | TX40 | TX45
- Hexagon Key Wrench Set 1.5 | 2 | 2.5 | 3 | 4 | 5 | 5.5 | 6 mm

Art.-No.	H x B x T (mm) H x W x L (mm)		
2490003	50 x 440 x 270	4356	1

Einzelteile entsprechen der DIN | parts according to DIN





360

12,5 1/2" 

STECKSCHLÜSSEL-EINSATZ, 6-KANT, DIN 3124
SOCKET, 6-POINT, DIN 3124

DIN 2725-1, DIN 3120 C,
ISO 1174-1
Chrom-Vanadium Stahl
verchromt

DIN 2725-1, DIN 3120 C,
ISO 1174-1
Chrome-Vanadium steel
chrome plated

Art.-No.	 mm	l-mm-l	 g	
3600803	8	38	48	10
3600903	9	38	48	10
3601003	10	38	49	10
3601103	11	38	50	10
3601203	12	38	50	10
3601303	13	38	52	10
3601403	14	38	54	10
3601503	15	38	56	10
3601603	16	38	50	10
3601703	17	38	64	10
3601803	18	38	76	10
3601903	19	38	66	10
3602003	20	38	78	10
3602103	21	38	73	10
3602203	22	39	82	10
3602303	23	38	94	10
3602403	24	38	108	10
3602503	25	42	142	10
3602603	26	42	132	10
3602703	27	42	159	10
3602803	28	42	169	10
3602903	29	42	170	10
3603003	30	42	199	10
3603203	32	43	219	10
3603303	33	44	260	10
3603403	34	44	260	10
3603603	36	45	310	10



350

12,5 1/2" 

STECKSCHLÜSSEL-EINSATZ, 12-KANT, DIN 3124
SOCKET, 12-POINT, DIN 3124

DIN 2725-1, DIN 3120 C,
ISO 1174-1
Chrom-Vanadium Stahl
verchromt

DIN 2725-1, DIN 3120 C,
ISO 1174-1
Chrome-Vanadium steel
chrome plated

Art.-No.	 mm	l-mm-l	 g	
3500803	8	38	46	10
3500903	9	38	48	10
3501003	10	38	48	10
3501103	11	38	49	10
3501203	12	38	50	10
3501303	13	38	51	10
3501403	14	38	52	10
3501503	15	38	56	10
3501603	16	38	56	10
3501703	17	38	60	10
3501803	18	38	74	10
3501903	19	38	62	10
3502003	20	38	76	10
3502103	21	38	76	10
3502203	22	39	90	10
3502303	23	39	102	10
3502403	24	39	120	10
3502503	25	42	136	10
3502603	26	42	128	10
3502703	27	42	158	10
3502803	28	42	170	10
3502903	29	42	162	10
3503003	30	42	184	10
3503203	32	44	204	10



350/1



STECKSCHLÜSSEL-EINSATZ, 12-KANT, DIN 3124
SOCKET, 12-POINT, DIN 3124

ISO 2725-1, DIN 3120 C,
ISO 1174-1
Chrom-Vanadium Stahl
verchromt

ISO 2725-1, DIN 3120 C,
ISO 1174-1
Chrome-Vanadium steel
chrome plated

Art.-No.	⌀AF"	l-mm-l	g	☐
9248553	5/16"	40	58	10
9248563	3/8"	40	58	10
9248573	7/16"	40	62	10
9248583	15/32"	40	62	10
9248593	1/2"	40	61	10
9248603	9/16"	40	64	10
9248613	19/32"	40	66	10
9248623	5/8"	40	73	10
9248633	21/32"	40	62	10
9248643	11/16"	40	66	10
9248653	23/32"	40	71	10
9248663	3/4"	40	82	10
9248673	25/32"	40	86	10
9248683	13/16"	40	90	10
9248693	7/8"	40	100	10
9248703	15/16"	40	117	10
9248713	31/32"	40	122	10
9248723	1"	40	143	10
9248733	1.1/16"	45	162	10
9248743	1.1/8"	45	175	10
9248753	1.3/16"	45	161	10
9248763	1.1/4"	47	231	10

396



STECKSCHLÜSSEL-EINSATZ, 6-KANT, DIN 3124
SOCKET, 6-POINT, DIN 3124

DIN 2725-1, DIN 3120 C,
ISO 1174-1
lange Ausführung
Chrom-Vanadium Stahl
verchromt

DIN 2725-1, DIN 3120 C,
ISO 1174-1
long type
Chrome-Vanadium steel
chrome plated

Art.-No.	⌀mm	l-mm-l	g	☐
9248773	10	76	94	10
9248503	11	76	91	10
9248513	12	77	100	10
9248783	13	77	107	10
9248793	14	76	120	10
9248803	17	77	120	10
9248813	19	77	135	10
9248823	22	77	229	10
9248833	24	77	257	10
9248843	27	77	335	10



361

12,5 1/2"

SCHRAUBENDREHER-EINSATZ SCREWDRIVER SOCKET

DIN 3120 C, DIN 5264,
DIN ISO 2380-1, ISO 1174-1
für Schlitzschrauben
Chrom-Vanadium Stahl
verchromt

DIN 3120 C, DIN 5264,
DIN ISO 2380-1, ISO 1174-1
für slotted screws
Chrome-Vanadium steel
chrome plated

Art.-No.	mm	l-mm-l	g	
9208453	8	53	76	10
9208463	10	53	78	10
9208473	12	52	80	10

362

12,5 1/2"

PH SCHRAUBENDREHER-EINSATZ PH SCREWDRIVER SOCKET

DIN 3120 C, DIN ISO 8764-1,
ISO 1174-1
für PH Kreuzschlitzschrauben
Chrom-Vanadium Stahl
verchromt

DIN 3120 C, DIN ISO 8764-1,
ISO 1174-1
für PH screws
Chrome-Vanadium steel
chrome plated

Art.-No.		l-mm-l	g	
9208493	PH2	60	80	10
9208503	PH3	55	84	10
9208513	PH4	55	86	10



363

12,5 1/2"

INNENSECHSKANT-SCHRAUBENDREHER-EINSATZ, DIN 7422 INSIDE HEXAGON SCREWDRIVER SOCKET, DIN 7422

DIN 3120 C, ISO 1174-1
für Innensechskant-Schrauben
Chrom-Vanadium Stahl
verchromt

DIN 3120 C, ISO 1174-1
für inside hexagon screws
Chrome-Vanadium steel
chrome plated

Art.-No.		l-mm-l	g	
9208523	4	55	74	10
9208533	5	55	68	10
9229933	5	100	102	10
9208543	6	55	68	10
9229943	6	100	102	10
9210833	7	55	68	10
9211183	7	100	106	10
9208553	8	55	70	10
9208563	8	100	106	10
9208573	10	55	74	10
9208583	10	100	110	10
9208593	12	55	84	10
9274993	12	100	136	10
9208603	14	55	110	10
9216983	17	55	154	10
9216993	19	55	162	10

357

12,5 1/2"

TX SCHRAUBENDREHER-EINSATZ TX SCREWDRIVER SOCKET

DIN 3120 C, ISO 1174-1
für Innen-TORX®-Schrauben
Chrom-Vanadium Stahl
verchromt

DIN 3120 C, ISO 1174-1
für inside TORX®-screws
Chrome-Vanadium steel
chrome plated

Art.-No.		M	l-mm-l	g	
9217003	TX20	4-5	55	74	10
9217013	TX25	4,5-5	55	66	10
9217023	TX27	4,5-6	55	66	10
9217033	TX30	6-7	55	68	10
9217043	TX40	7-8	55	68	10
9217053	TX45	8-10	55	70	10
9217063	TX50	10	55	70	10
9217073	TX55	12	55	74	10
9217083	TX60	14	55	82	10



349

XZN SCHRAUBENDREHER-EINSATZ XZN SCREWDRIVER SOCKET



DIN 3120 C, ISO 1174-1
für XZN-Schrauben
Chrom-Vanadium Stahl
verchromt

DIN 3120 C, ISO 1174-1
für XZN screws
Chrome-Vanadium steel
chrome plated

Art.-No.		l-mm-l		
9217163	M5	52	64	10
9217173	M6	55	74	10
9286113	M6	100	104	10
9217183	M8	55	75	10
9217193	M8	100	104	10
9217203	M10	55	76	10
9217213	M10	100	106	10
9217223	M12	55	86	10
9217233	M12	100	130	10
9234843	M14	55	92	10
9286153	M14	100	150	10

für Schrauben mit Innenverzahnung RIBE auf Anfrage
for spline socket head screws (RIBE CV) on request

347

E-TX SCHRAUBENDREHER-EINSATZ E-TX SCREWDRIVER SOCKET



DIN 3120 C, ISO 1174-1
für Außen-TORX®-Schrauben
Chrom-Vanadium Stahl
verchromt

DIN 3120 C, ISO 1174-1
für outside TORX®- screws
Chrome-Vanadium steel
chrome plated

Art.-No.		M	l-mm-l		
9248853	E10	8	38	50	10
9248863	E11	10	38	60	10
9248873	E12	10	38	52	10
9248883	E14	12	38	53	10
9248893	E16	12	38	54	10
9248903	E18	14	38	56	10
9248913	E20	16	38	72	10
9248923	E24	18-20	38	122	10



389

ZÜNDKERZEN-EINSATZ SPARK PLUG SOCKET



DIN 3120 C, ISO 1174-1
Chrom-Vanadium Stahl
verchromt
mit Gummihalter

DIN 3120 C, ISO 1174-1
Chrome-Vanadium steel
chrome plated
with rubber insert

Art.-No.		l-mm-l		
9212883	16	65	92	10
9229923	21	65	136	10

872

UNIVERSALSCHLÜSSEL FÜR VENTILNIPPEL UNIVERSAL WRENCH FOR VALVES



DIN 2725-1, DIN 3120 C,
ISO 1174-1
Chrom-Vanadium Stahl
verchromt

DIN 2725-1, DIN 3120 C,
ISO 1174-1
Chrome-Vanadium steel
chrome plated

Art.-No.		l-mm-l		
9291113	3/8" 12 mm 1/2" 3/4" 1" 1.1/4"	112	234	5



352

KARDAN-GELENK, DIN 3123 C UNIVERSAL JOINT, DIN 3123 C

12,5 1/2" □ □

DIN 3120 A/C, ISO 1174-1,
ISO 3316
Chrom-Vanadium Stahl
verchromt

DIN 3120 A/C, ISO 1174-1,
ISO 3316
Chrome-Vanadium steel
chrome plated

Art.-No.	l-mm-l	g	□
9200123	73	160	10

368

ÜBERGANGSTEIL, DIN 3123 A ADAPTOR, DIN 3123 A

12,5 1/2" □ □

20 3/4" □ □

DIN 3120 A/C, ISO 1174-1,
ISO 3316
Chrom-Vanadium Stahl
verchromt
1/2" innen, 3/4" außen

DIN 3120 A/C, ISO 1174-1,
ISO 3316
Chrome-Vanadium steel
chrome plated
1/2" female, 3/4" male

Art.-No.	l-mm-l	g	□
9225373	51	141	10



369

ÜBERGANGSTEIL, DIN 3123 A ADAPTOR, DIN 3123 A

12,5 1/2" □ □

10 3/8" □ □

DIN 3120 A/C, ISO 1174-1,
ISO 3316
Chrom-Vanadium Stahl
verchromt
1/2" innen, 3/8" außen

DIN 3120 A/C, ISO 1174-1,
ISO 3316
Chrome-Vanadium steel
chrome plated
1/2" female, 3/8" male

Art.-No.	l-mm-l	g	□
9223643	36	51	10

358

VERBINDUNGSVIERKANT, DIN 3122 SQUARE COUPLER, DIN 3122

12,5 1/2" □ □

DIN 3120 A, ISO 1174-1
Chrom-Vanadium Stahl
verchromt

DIN 3120 A, ISO 1174-1
Chrome-Vanadium steel
chrome plated

Art.-No.	l-mm-l	g	□
9201343	36	42	10



3351

BIT-ADAPTER, DIN 3126
BIT ADAPTOR, DIN 3126

DIN 3120 C, DIN 3126,
ISO 1173, ISO 1174-1
mit Haltefeder für Bitaufnahme
Chrom-Vanadium Stahl
verchromt

DIN 3120 C, DIN 3126,
ISO 1173, ISO 1174-1
with retaining spring for bit use
Chrome-Vanadium steel
chrome plated



Art.-No.			l-mm-l		
3351103	1/2"	10 mm	36	49	10
9259303	1/2"	1/4"	37	51	10
9259313	1/2"	5/16"	37	56	10



356

VERLÄNGERUNG, DIN 3123 B
EXTENSION BAR, DIN 3123 B

DIN 3120 A/C, ISO 1174-1,
ISO 3316
Chrom-Vanadium Stahl
verchromt

DIN 3120 A/C, ISO 1174-1,
ISO 3316
Chrome-Vanadium steel
chrome plated



Art.-No.	l-mm-l		
9224693	75	123	10
9200103	125	198	10
9200113	250	387	10



370

VERLÄNGERUNG MIT WOBBLE-DRIVE
EXTENSION BAR WITH WOBBLE-DRIVE

DIN 3120 A/C, ISO 1174-1
Chrom-Vanadium-Stahl
verchromt

DIN 3120 A/C, ISO 1174-1
Chrome Vanadium steel
chrome plated



Art.-No.	l-mm-l		
9285780	126	215	10



354

GRIFF MIT GLEITSTÜCK, DIN 3122 A
SLIDING T-HANDLE, DIN 3122 A

DIN 3120 A/C, ISO 1174-1,
ISO 3316
Chrom-Vanadium Stahl
verchromt

DIN 3120 A/C, ISO 1174-1,
ISO 3316
Chrome-Vanadium steel
chrome plated



Art.-No.	l-mm-l		
9200093	300	421	10



346

MASCHINEN-ADAPTER, DIN 3126 MACHINERY ADAPTOR, DIN 3126



DIN 3121, DIN 3126,
ISO 1174-1, ISO 3317
Chrom-Vanadium Stahl
stahlgrau
1/2" außen, 1/4" außen

DIN 3121, DIN 3126,
ISO 1174-1, ISO 3317
Chrome-Vanadium steel
grey finish
1/2" male, 1/4" male

Art.-No.	l-mm-l		
34612147	72	46	10



377

MASCHINEN-ADAPTER SET MACHINERY ADAPTOR SET



DIN 3121, DIN 3126,
ISO 1174-1, ISO 3317
Chrom-Vanadium Stahl
stahlgrau
1/4" | 3/8" | 1/2" außen, 1/4" außen

DIN 3121, DIN 3126,
ISO 1174-1, ISO 3317
Chrome-Vanadium steel
grey finish
1/4" | 3/8" | 1/2" male, 1/4" male

Art.-No.	l-mm-l		
9011147	1/4" 3/8" 1/2"	108	1



359

VERLÄNGERUNG MIT KARDANGELENK UND T-GRIFF EXTENSION BAR WITH UNIVERSAL JOINT AND T-HOLDER



DIN 3120 A, DIN 3120 C, ISO 1174-1
Chrom-Vanadium-Stahl
verchromt
2-tlg.
T-Griff-Verlängerung
mit Kardan-Gelenk

DIN 3120 A, DIN 3120 C, ISO 1174-1
Chrome-Vanadium steel
chrome plated
2 pcs.
Extension Bar with T-handle
with Universal Joint

Art.-No.	l-mm-l		
9296063	500	724	1

355

ZÜNDKERZEN-WERKZEUG-SET SPARK PLUG TOOL-SET



DIN 3120 A, DIN 3120 C, ISO 1174-1
Chrom-Vanadium Stahl
verchromt
4-tlg.
T-Griff-Verlängerung
mit Kardan-Gelenk
Zündkerzeneinsatz 17 | 19 mm

DIN 3120 A, DIN 3120 C, ISO 1174-1
Chrome-Vanadium steel
chrome plated
4 pcs.
Extension Bar with T-handle
with Universal Joint
Spark Plug Socket 17 | 19 mm

Art.-No.	l-mm-l		
9296073	500	970	1



353

KURBEL, DIN 3123
SPREADER HANDLE, DIN 3123

DIN 3120 A, ISO 1174-1,
ISO 3315
Chrom-Vanadium Stahl
verchromt
2-Komponentenheft

DIN 3120 A, ISO 1174-1,
ISO 3315
Chrome-Vanadium steel
chrome plated
two component handle

Art.-No.	l-mm-l		
3534600	420	448	5



365

GELENKGRIF, DIN 3122 F
FLEXIBLE HANDLE, DIN 3122 F

DIN 3120 A, ISO 1174-1,
ISO 3315
Chrom-Vanadium Stahl
verchromt
2-Komponentenheft

DIN 3120 A, ISO 1174-1,
ISO 3315
Chrome-Vanadium steel
chrome plated
two component handle

Art.-No.	l-mm-l		
3650003	280	512	5



3068

GERÜSTBAU-RATSCHKE 32 ZÄHNE, UMSCHALTBAR
STAGING RATCHET 32 TEETH, REVERSIBLE

Chrom-Vanadium Stahl | schwarz phosphatiert

Art.-No.	mm		l-mm-l		
306813174	13 x 17	32	280	274	5
306816184	16 x 18	32	315	468	5
306817194	17 x 19	32	315	471	5
9300600	19 x 21	32	315	460	5
9299540	19 x 22	32	315	460	5



Chrom-Vanadium steel | black phosphated

Art.-No.	mm		l-mm-l		
306819244	19 x 24	32	315	430	5
306824304	24 x 30	32	445	1326	1
306827324	27 x 32	32	445	1294	1
306836414	36 x 41	32	445	1343	1

351

KNARRE UMSTECKBAR, 30 ZÄHNE, DIN 3122 C
PUSH-THROUGH RATCHET, 30 TEETH, DIN 3122 C

DIN 3120 A/C, ISO 1174-1, ISO 3315
Chrom-Vanadium Stahl | verchromt
2-Komponentenheft
mit Verbindungsvierkant



DIN 3120 A/C, ISO 1174-1, ISO 3315
Chrome-Vanadium steel | chrome plated
two component handle
with square coupler

Art.-No.		l-mm-l		
9200073	30	270	556	5



3066

12,5 1/2"

HEBELUMSCHALTKNARRE, 72 ZÄHNE, GEBOGENER SCHAFT, DIN 3122 D
REVERSIBLE RATCHET, LEVER TYPE, 72 TEETH, CURVED SHAFT, DIN 3122 D

DIN 3120 A, ISO 1174-1, ISO 3315 Chrom-Vanadium Stahl verchromt
2-Komponentenheft

DIN 3120 A, ISO 1174-1, ISO 3315 Chrome-Vanadium steel chrome plated
two component handle

Art.-No.		l-mm-l		
3066003	72	260	438	5

3067

12,5 1/2"

HEBELUMSCHALTKNARRE, 72 ZÄHNE, GERADER SCHAFT, DIN 3122 D
REVERSIBLE RATCHET, LEVER TYPE, 72 TEETH, STRAIGHT SHAFT, DIN 3122 D

DIN 3120 A, ISO 1174-1, ISO 3315 Chrom-Vanadium Stahl verchromt
2-Komponentenheft

DIN 3120 A, ISO 1174-1, ISO 3315 Chrome-Vanadium steel chrome plated
two component handle

Art.-No.		l-mm-l		
9291733	72	260	530	5

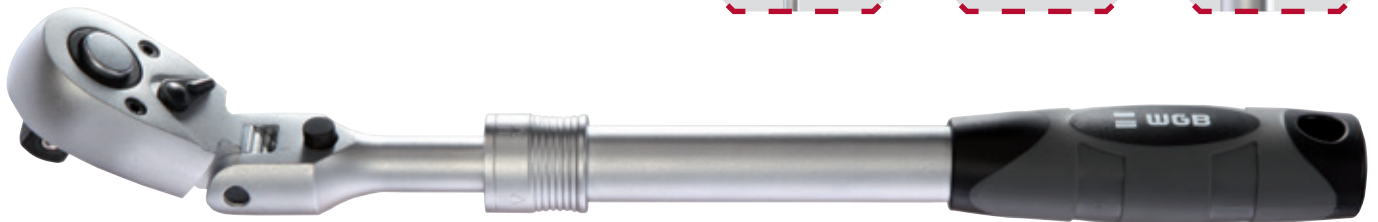

3511

12,5 1/2"

GELENK-TELESKOP-HEBELUMSCHALTKNARRE, 72 ZÄHNE, DIN 3122 D
JOINT EXTENDABLE REVERSIBLE RATCHET, 72 TEETH, DIN 3122 D

DIN 3120 A, ISO 1174-1, ISO 3315 Chrom-Vanadium Stahl verchromt
2-Komponentenheft

DIN 3120 A, ISO 1174-1, ISO 3315 Chrome-Vanadium steel chrome plated
two component handle

Art.-No.		l-mm-l		
3511003	72	350-490	1110	10



3359

12,5 1/2"

UMSCHALTKNARRE, 45 ZÄHNE, DIN 3122 D
REVERSIBLE RATCHET, 45 TEETH, DIN 3122 D

DIN 3120 A, ISO 1174-1, ISO 3315
Chrom-Vanadium Stahl
verchromt
2-Komponentenheft

DIN 3120 A, ISO 1174-1, ISO 3315
Chrome-Vanadium steel
chrome plated
two component handle

Art.-No.		l-mm-l		
9291703	45	260	550	5

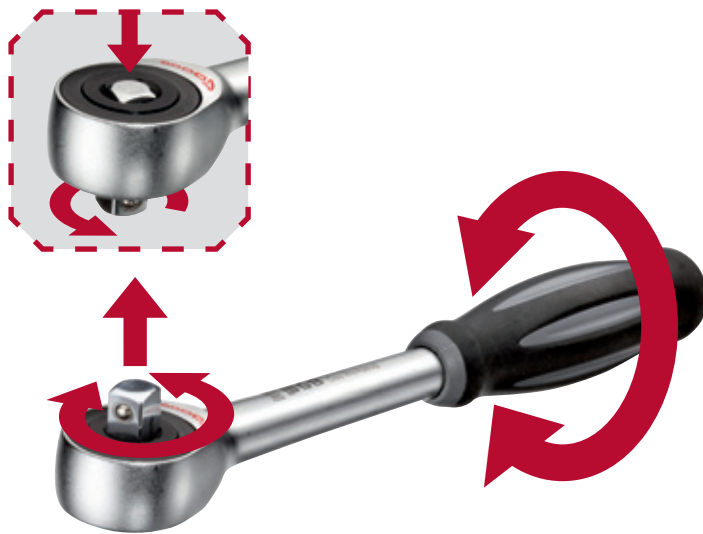

372

ROTATIONSKNARRE, 60 ZÄHNE, DIN 3122 D
REVERSIBLE RATCHET, TURNABLE, 60 TEETH, DIN 3122 D

DIN 3120 A, ISO 1174-1, ISO 3315
Chrom-Vanadium Stahl | verchromt | drehbares 2-Komponentenheft

- durch Drehen des Handgriffes um die eigene Achse (egal in welche Richtung) dreht sich der Antriebsvierkant in die gleiche Richtung und schraubt in den unzugänglichsten Positionen
- zusätzlich wie jede herkömmliche Knarre verwendbar
- ermöglicht das Arbeiten in allen Lagen
- hilft auch dort, wo herkömmliche Schraubwerkzeuge nicht anwendbar sind

Art.-No.		l-mm-l		
3720003	60	290	650	5

Voller Dreh für Problemfälle:

Full turn for problem cases:

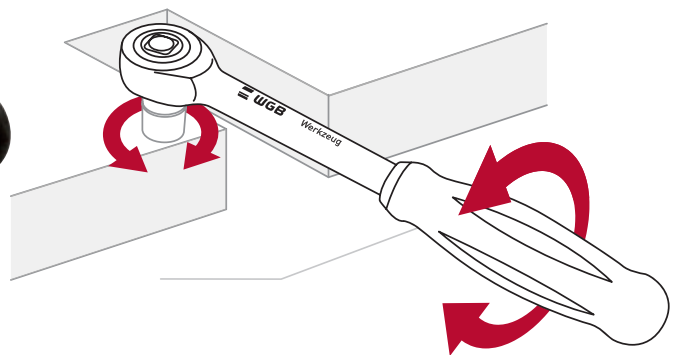

12,5 1/2"

DIN 3120 A, ISO 1174-1, ISO 3315
Chrom-Vanadium steel | chrome plated | turnable two component handle

- by turning the handle around its own axis (no matter which direction) the square drive turns in the same direction and screws in the most inaccessible positions
- can also be used like any conventional ratchet
- enables working in all positions
- also helps where conventional screwing tools cannot be used





375

DURCHSTECK-DOPPELRING-EINSATZ
GO-THROUGH DOUBLE RING SOCKET

DIN ISO 691, DIN ISO 1711-1
Chrom-Vanadium Stahl | verchromt

DIN ISO 691, DIN ISO 1711-1
Chrome-Vanadium steel | chrome plated

Art.-No.	mm	mm	g	
37506083	6x8	16	20	10
37509103	9x10	16	16	10
37511123	11x12	10	11	10
37513153	13x15	19	22	10
37516173	16x17	19	17	10



375/1

DURCHSTECK-DOPPELRING-EINSATZ
GO-THROUGH DOUBLE RING SOCKET

DIN ISO 691, DIN ISO 1711-1
Chrom-Vanadium Stahl | verchromt

DIN ISO 691, DIN ISO 1711-1
Chrome-Vanadium steel | chrome plated

Art.-No.	AF"	mm	g	
37514513	1/4" x 5/16"	16	20	10
37538713	3/8" x 7/16"	16	19	10
37593213	9/32" x 11/32"	16	14	10
37512193	1/2" x 19/32"	19	31	10
37558113	5/8" x 11/16"	19	25	10
37591633	9/16" x 3/4"	24	15	10



376

DURCHSTECK-ADAPTER
GO-THROUGH ADAPTOR

DIN 3120 A
Chrom-Vanadium Stahl | verchromt

DIN 3120 A
Chrome-Vanadium steel | chrome plated

Art.-No.		mm	g	
37601403	1/4"	22	16	10
37603803	3/8"	25	22	10
37601203	1/2"	31	49	10



518

DURCHSTECK-BIT-ADAPTER
GO-THROUGH BIT ADAPTOR

Chrom-Vanadium Stahl
verchromt

Chrome-Vanadium steel
chrome plated

Art.-No.		mm	g	
51801403	1/4"	17	17	10

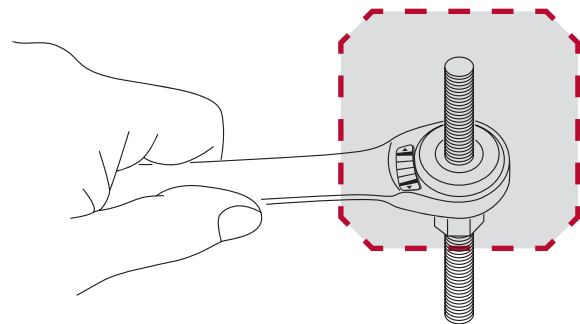

298

DOPPELRING-RATSCHENSCHLÜSSEL FÜR DURCHSTECK-STECKSCHLÜSSEL-EINSÄTZE
DOUBLE RING RATCHET SPANNER FOR GO-THROUGH SOCKETS

DIN ISO 691, DIN ISO 1711
Chrom-Vanadium Stahl | verchromt

DIN ISO 691, DIN ISO 1711
Chrome-Vanadium steel | chrome plated

Art.-No.	mm		mm	g	
29814193	14 x 19	72	205	179	10

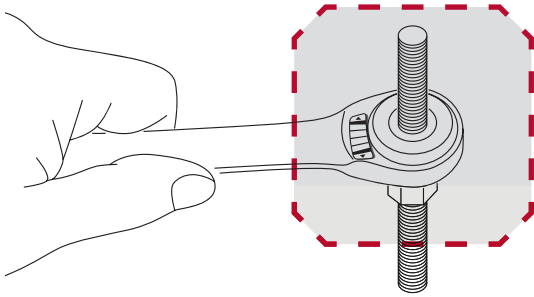

METRISCH UND ZÖLLIG

METRIC AND IMPERIAL



BETÄTIGUNGSWERKZEUGE GARNITUREN
 SOCKETS & ACCESSORIES SOCKET SETS
04

3970

DURCHSTECK-DOPPELRING-RATSCHENSCHLÜSSEL-SATZ „28 IN 1“

GO-THROUGH DOUBLE-BOX GEAR WRENCH SET „28 IN 1“

Chrom-Vanadium Stahl, verchromt

16-tlg.

in Stahlblechkasten

in säure- und schmierstoffbeständiger Schaumstoffeinlage

Doppelring-Ratschenschlüssel mit:

Durchsteck-Steckschlüssel-Einsatz 6x8 | 9x10 | 11x12 | 13x15 | 16x17 mm

Durchsteck-Steckschlüsseleinsatz 1/4" x 5/16" | 9/32" x 11/32" | 3/8" x 7/16" | 1/2" x 19/32" | 5/8" x 11/16" | 9/16" x 3/4"

Adapter 1/4" | 3/8" | 1/2" für Einsatz als herkömmliche Knarre

Bit-Adapter 1/4"



Chrome-Vanadium steel, chrome plated

16 pcs.

in metal box

in acid and lubricant resistant foam insert

Double-Box Gear Wrench with:

Go-Through Socket 6x8 | 9x10 | 11x12 | 13x15 | 16x17 mm

Go-Through Socket 1/4" x 5/16" | 9/32" x 11/32" | 3/8" x 7/16" | 1/2" x 19/32" | 5/8" x 11/16" | 9/16" x 3/4"

Adaptor 1/4" | 3/8" | 1/2" for using ratchet conventionally

Bit Adaptor 1/4"

Art.-No.



H x B x T (mm)
H x W x L (mm)



3970003

72

40 x 240 x 117

1090

1

Einzelteile entsprechen der DIN | parts according to DIN



367



SONDERPROFIL DURCHSTECK-STECKSCHLÜSSEL-EINSATZ SPECIAL PROFILE GO-TROUGH SOCKET

DIN ISO 1711-1
Chrom-Vanadium Stahl | verchromt
für zöllig, E-TX, XZN, 12-kant, 6-kant
und 4-kant

DIN ISO 1711-1
Chrome-Vanadium steel | chrome
plated for imperial, E-TX, XZN,
12-point, 6-point and 4-point

Art.-No.	Ø mm	l mm-l	g	📦
3670803	8	16	39	10
3670903	9	16	38	10
3671003	10	16	36	10
3671103	11	16	25	10
3671203	12	16	32	10
3671303	13	16	30	10
3671403	14	16	25	10
3671503	15	16	25	10
3671603	16	19	30	10
3671703	17	19	25	10



378



DURCHSTECK-STECKSCHLÜSSEL-VERLÄNGERUNG GO-TROUGH SOCKET EXTENSION

DIN ISO 1711-1
Chrom-Vanadium Stahl | verchromt

DIN ISO 1711-1
Chrome-Vanadium steel | chrome plated

Art.-No.	Ø mm	l mm-l	g	📦
3780013	19	75	139	10

379



DURCHSTECK-STECKSCHLÜSSEL-ADAPTER GO-TROUGH SOCKET ADAPTOR

DIN 3120 A
Chrom-Vanadium Stahl | verchromt

DIN 3120 A
Chrome-Vanadium steel | chrome plated

Art.-No.	Ø mm	l mm-l	g	📦
3790003	19	33	52	10



373

DURCHSTECKKNARRE, 72 ZÄHNE GO-TROUGH RATCHET, 72 TEETH

Chrom-Vanadium Stahl | verchromt

Chrome-Vanadium steel | chrome plated

Art.-No.	🦷	l mm-l	g	📦
3730003	72	210	240	10



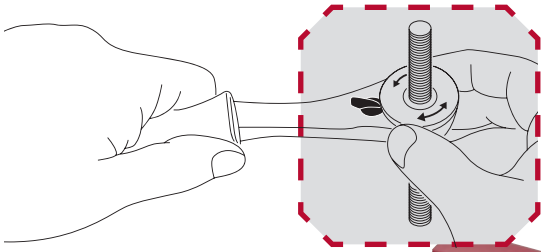

3960

DURCHSTECK-STECKSCHLÜSSEL-GARNITUR „40 IN 1“ GO-THROUGH SOCKET SET „40 IN 1“

Chrom-Vanadium Stahl
verchromt
in säure- und schmierstoffbeständiger Schaumstoffeinlage
13-tlg.
im Stahlblechkasten

Durchsteckknarre, 72 Zähne, 210 mm, mit Magnetscheibe
Verlängerung 19 mm x 75 mm
Adapter 19 mm x 1/2" für Einsatz als herkömmliche Knarre
Sonderprofil Durchsteck-Steckschlüssel-Einsatz 8 | 9 | 10 | 11 | 12 |
13 | 14 | 15 | 16 | 17 mm
Steckschlüssel-Einsätze auch verwendbar für:
Zoll: 5/16 | 11/32 | 3/8 | 7/16 | 15/32 | 1/2 | 9/16 | 19/32 | 5/8 | 11/16"
E-TX: E10 | E11 | E12 | E14 | E16 | E18 | E20
XZN: 8 | 9 | 10 | 11 | 12 | 14 | 16



Chrome-Vanadium steel
chrome plated
in acid and lubricant resistant foam insert
13 pcs.
in metal box

Go-Through Ratchet, 72 teeth, 210 mm, with magnetic disk
Go-Through Socket Extension 19 mm x 75 mm
Adaptor 19 mm x 1/2" for using ratchet conventionally
Special profile Go-Through Socket 8 | 9 | 10 | 11 | 12 |
13 | 14 | 15 | 16 | 17 mm
Go-Trough Sockets also adaptable for:
Inch: 5/16 | 11/32 | 3/8 | 7/16 | 15/32 | 1/2 | 9/16 | 19/32 | 5/8 | 11/16"
E-TX: E10 | E11 | E12 | E14 | E16 | E18 | E20
XZN: 8 | 9 | 10 | 11 | 12 | 14 | 16

Art.-No.		H x B x T (mm) H x W x L (mm)		
3960003	72	40 x 240 x 117	1332	1

Einzelteile entsprechen der DIN | parts according to DIN



3950

INNENSECHSKANT-STECKSCHLÜSSEL-GARNITUR INSIDE HEXAGON SOCKET SET,

Chrom-Vanadium Stahl
verchromt
für Innensechskant-Schrauben
10-tlg.
im Stahlblechkasten

12,5 1/2" 

Chrome-Vanadium steel
chrome plated
for inside hexagon screws
10 pcs.
in metal box

Art.-No.		H x B x T (mm) H x W x L (mm)		
3950003	4 5 6 7 8 10 12 14 17 19	47 x 239 x 95	1262	1

Einzelteile entsprechen der DIN | parts according to DIN



3910

INNENSECHSKANT-STECKSCHLÜSSEL-GARNITUR INSIDE HEXAGON SOCKET SET

Chrom-Vanadium Stahl
verchromt
18-tlg.
im Stahlblechkasten

1/4" Innensechskant-Schraubendreher-Einsatz 2 | 2,5 | 3 | 4 | 5 | 6 mm
1/2" Innensechskant-Schraubendreher-Einsatz 6 | 7 | 8 | 10 | 12 | 14 mm
1/2" Innensechskant-Schraubendreher-Einsatz, lang 5 | 6 | 7 | 8 |
10 | 12 mm

6,3 1/4" 12,5 1/2" 

Chrome-Vanadium steel
chrome plated
18 pcs.
in metal box

1/4" Inside Hexagon Screwdriver Socket 2 | 2,5 | 3 | 4 | 5 | 6 mm
1/2" Inside Hexagon Screwdriver Socket 6 | 7 | 8 | 10 | 12 | 14 mm
1/2" Inside Hexagon Screwdriver Socket, long 5 | 6 | 7 | 8 |
10 | 12 mm

Art.-No.	H x B x T (mm) H x W x L (mm)		
9291653	38 x 242 x 117	1782	1

Einzelteile entsprechen der DIN | parts according to DIN



3940

TX STECKSCHLÜSSEL-GARNITUR TX SOCKET SET



Chrom-Vanadium Stahl
verchromt
23-tlg.
im Stahlblechkasten

1/4" TR Schraubendreher-Einsatz TR8 | TR10 | TR15 | TR20 | TR25 | TR27 | TR30
1/4" E-TX Schraubendreher-Einsatz E4 | E5 | E6 | E8
1/2" TX Schraubendreher-Einsatz TX40 | TX45 | TX50 | TX55 | TX60
1/2" E-TX Schraubendreher-Einsatz E10 | E12 | E14 | E18
TX Stiftschlüssel TX6 | TX8 | TX10



Chrome-Vanadium steel
chrome plated
23 pcs.
in metal box

1/4" TR Screwdriver Socket TR8 | TR10 | TR15 | TR20 | TR25 | TR27 | TR30
1/4" E-TX Screwdriver Socket E4 | E5 | E6 | E8
1/2" TX Screwdriver Socket TX40 | TX45 | TX50 | TX55 | TX60
1/2" E-TX Screwdriver Socket E10 | E12 | E14 | E18
TX Key Wrench TX6 | TX8 | TX10

Art.-No.	H x B x T (mm) H x W x L (mm)		
9291643	38 x 242 x 117	1346	1

Einzelteile entsprechen der DIN | parts according to DIN



3900

XZN STECKSCHLÜSSEL-GARNITUR XZN SOCKET SET

Chrom-Vanadium Stahl
verchromt
18-tlg.
im Stahlblechkasten

1/2" XZN Schraubendreher-Einsatz M5 | M6 | M8 | M10 | M12 | M14
1/2" XZN Schraubendreher-Einsatz, lang M6 | M8 | M9 | M10 | M12 | M14
1/2" Steckschlüssel-Einsatz, 12-kant 9 | 10 | 12 | 18 | 19 | 21 mm



Chrome-Vanadium steel
chrome plated
18 pcs.
in metal box

1/2" XZN Screwdriver Socket M5 | M6 | M8 | M10 | M12 | M14
1/2" XZN Screwdriver Socket, long M6 | M8 | M9 | M10 | M12 | M14
1/2" Socket, 12-point 9 | 10 | 12 | 18 | 19 | 21 mm

Art.-No.	H x B x T (mm) H x W x L (mm)		
9291673	43 x 298 x 131	2310	1

Einzelteile entsprechen der DIN | parts according to DIN



3880

STECKSCHLÜSSEL-GARNITUR SOCKET SET

Chrom-Vanadium Stahl
verchromt
29-tlg.
im Stahlblechkasten

- 1/2" Steckschlüssel-Einsatz, 6-kant 8 | 9 | 10 | 11 | 12 | 13 | 14 | 15 | 16 | 17 | 18 | 19 | 20 | 21 | 22 | 24 | 27 | 30 | 32 mm
- 1/2" Steckschlüssel-Einsatz, 6-kant, lang 10 | 13 | 17 mm
- 1/2" Zündkerzen-Einsatz 16 | 21 mm
- 1/2" Kardan-Gelenk
- 1/2" Verlängerung 125 | 250 mm
- 1/2" Adapter-Gleitstück 3/8" x 1/2"
- 1/2" Umschaltknarre, 45 Zähne 250 mm



Chrome-Vanadium steel
chrome plated
29 pcs.
in metal box

- 1/2" Socket, 6-point 8 | 9 | 10 | 11 | 12 | 13 | 14 | 15 | 16 | 17 | 18 | 19 | 20 | 21 | 22 | 24 | 27 | 30 | 32 mm
- 1/2" Socket, 6-point, long 10 | 13 | 17 mm
- 1/2" Spark Plug Socket 16 | 21 mm
- 1/2" Universal Joint
- 1/2" Extension Bar 125 | 250 mm
- 1/2" Sliding T-Adaptor 3/8" x 1/2"
- 1/2" Reversible Ratchet, 45 teeth 250 mm

Art.-No.	H x B x T (mm) H x W x L (mm)		
9291623	47 x 442 x 182	4908	1

Einzelteile entsprechen der DIN | parts according to DIN



3920

STECBSCHLÜSSEL-GARNITUR SOCKET SET

Chrom-Vanadium Stahl
verchromt
56-tlg.
im Stahlblechkasten

- 1/4" Steckschlüssel-Einsatz, 6-kant
4 | 4,5 | 5 | 5,5 | 6 | 7 | 8 | 9 | 10 | 11 | 12 | 13 mm
- 1/4" PH Schraubendreher-Einsatz PH1 | PH2
- 1/4" Schraubendreher-Einsatz 4 | 5,5 mm
- 1/4" Innensechskant-Schraubendreher-Einsatz 3 | 4 | 5 | 6 mm
- 1/4" TR Schraubendreher-Einsatz TR20 | TR25 | TR27 | TR30
- 1/4" Kardan-Gelenk
- 1/4" Verlängerung 50 | 100 mm
- 1/4" Adapter-Gleitstück 3/8" x 1/4"
- 1/4" Steckgriff mit 1/4" Antriebsvierkant
- 1/4" Umschaltknarre, 43 Zähne 140 mm
- 1/2" Steckschlüssel-Einsatz, 6-kant
10 | 11 | 12 | 13 | 14 | 15 | 16 | 17 | 19 | 22 | 24 | 27 | 30 | 32 mm
- 1/2" Zündkerzen-Einsatz 16 | 21 mm
- 1/2" Kardan-Gelenk
- 1/2" Verlängerung 75 | 250 mm
- 1/2" Adapter-Gleitstück 3/8" x 1/2"
- 1/2" Umschaltknarre, 45 Zähne 250 mm
- Sechskant-Stiftschlüssel 1,25 | 1,5 | 2 | 2,5 | 3 mm



Chrome-Vanadium steel
chrome plated
56 pcs.
in metal box

- 1/4" Socket, 6-point
4 | 4,5 | 5 | 5,5 | 6 | 7 | 8 | 9 | 10 | 11 | 12 | 13 mm
- 1/4" PH Screwdriver Socket PH1 | PH2
- 1/4" Screwdriver Socket 4 | 5,5 mm
- 1/4" Inside Hexagon Screwdriver Socket 3 | 4 | 5 | 6 mm
- 1/4" TR Screwdriver Socket TR20 | TR25 | TR27 | TR30
- 1/4" Universal Joint
- 1/4" Extension Bar 50 | 100 mm
- 1/4" Sliding Adaptor 3/8" x 1/4"
- 1/4" Spinner Handle with 1/4" Square Coupler
- 1/4" Reversible Ratchet, 43 teeth 140 mm
- 1/2" Socket, 6-point
10 | 11 | 12 | 13 | 14 | 15 | 16 | 17 | 19 | 22 | 24 | 27 | 30 | 32 mm
- 1/2" Spark Plug Socket 16 | 21 mm
- 1/2" Universal Joint
- 1/2" Extension Bar 75 | 250 mm
- 1/2" Sliding T-Adaptor 3/8" x 1/2"
- 1/2" Reversible Ratchet, 45 teeth 250 mm
- Hexagon Key Wrench 1.25 | 1.5 | 2 | 2.5 | 3 mm

Art.-No.	H x B x T (mm) H x W x L (mm)		
9291593	47 x 442 x 182	4890	1

Einzelteile entsprechen der DIN | parts according to DIN



3890

STECKSCHLÜSSEL-GARNITUR SOCKET SET



Chrom-Vanadium Stahl
verchromt
47-tlg.
im hochwertigen Kunststoffkoffer

- 1/2" Steckschlüssel-Einsatz, 6-kant 8 | 10 | 12 | 13 | 14 | 15 | 17 | 19 | 22 | 24 mm
- 1/2" Zündkerzen-Einsatz 16 | 21 mm
- 1/2" Kardan-Gelenk
- 1/2" Verlängerung 125 | 250 mm
- 1/2" Griff mit Gleitstück
- 1/2" Umschaltknarre, 45 Zähne 250 mm
- Wasserpumpenzange 250 mm
- Kombinationszange 175 mm
- Schlosser-Hammer 300 g
- Sechskant-Stiftschlüssel-Satz 1,5 | 2 | 2,5 | 3 | 4 | 5 | 6 | 8 mm
- Autolichtprüfer mit Kabel und Krokodilsklemme 3-48 V
- Ringmaulschlüssel 6 | 7 | 8 | 9 | 10 | 11 | 12 | 13 | 14 | 15 | 17 | 19 mm
- PH Schraubendreher PH1 | PH2
- Werkstatt-Schraubendreher 3,2 | 5 | 5,5 | 8 mm



Chrome-Vanadium steel
chrome plated
47 pcs.
in a high-quality plastic box

- 1/2" Socket, 6-point 8 | 10 | 12 | 13 | 14 | 15 | 17 | 19 | 22 | 24 mm
- 1/2" Spark Plug Socket 16 | 21 mm
- 1/2" Universal Joint
- 1/2" Extension Bar 125 | 250 mm
- 1/2" Sliding T-Handle
- 1/2" Reversible Ratchet, 45 teeth 250 mm
- Water Pump Pliers 250 mm
- Combination Pliers 175 mm
- Machinist's Hammer 300 g
- Hexagon Key Wrench Set 1,5 | 2 | 2,5 | 3 | 4 | 5 | 6 | 8 mm
- Car Reflector Tester with cable and clamp 3-48 V
- Combination Spanner 6 | 7 | 8 | 9 | 10 | 11 | 12 | 13 | 14 | 15 | 17 | 19 mm
- PH Screwdriver PH1 | PH2
- Engineers Screwdriver 3,2 | 5 | 5,5 | 8 mm

Art.-No.	H x B x T (mm) H x W x L (mm)		
9291663	81 x 410 x 314	6412	1

Einzelteile entsprechen der DIN | parts according to DIN



3930

STECKSCHLÜSSEL-GARNITUR SOCKET SET

Chrom-Vanadium Stahl
verchromt
65-tlg.
im hochwertigen Kunststoffkoffer

- 1/4" Steckschlüssel-Einsatz, 6-kant 4 | 5 | 5,5 | 6 | 6,5 | 7 | 8 | 9 | 10 | 11 | 12 | 13 mm
- 1/4" PH Schraubendreher-Einsatz PH1 | PH2
- 1/4" PZ Schraubendreher-Einsatz PZ1 | PZ2
- 1/4" Schraubendreher-Einsatz 4 | 5,5 | 7 mm
- 1/4" Innensechskant-Schraubendreher-Einsatz 3 | 4 | 5 | 6 mm
- 1/4" TR Schraubendreher-Einsatz TR8 | TR10 | TR15 | TR20 | TR25 | TR27 | TR30
- 1/4" Kardan-Gelenk
- 1/4" Verlängerung 50 | 100 mm
- 1/4" Adapter-Gleitstück 3/8" x 1/4"
- 1/4" Steckgriff mit 1/4" Antriebsvierkant
- 1/4" Umschaltknarre, 43 Zähne 140 mm
- 1/2" Steckschlüssel-Einsatz, 6-kant 10 | 11 | 12 | 13 | 14 | 15 | 16 | 17 | 18 | 19 | 21 | 22 | 24 | 27 | 30 | 32 | 34 mm
- 1/2" Zündkerzen-Einsatz 16 | 21 mm
- 1/2" Kardan-Gelenk
- 1/2" Verlängerung 75 | 250 mm
- 1/2" Adapter-Gleitstück 3/8" x 1/2"
- 1/2" Umschaltknarre, 45 Zähne 250 mm
- Sechskant-Stiftschlüssel 1,25 | 1,5 | 2 | 2,5 | 3 mm



Chrome-Vanadium steel
chrome plated
65 pcs.
in a high-quality plastic box

- 1/4" Socket, 6-point 4 | 5 | 5,5 | 6 | 6,5 | 7 | 8 | 9 | 10 | 11 | 12 | 13 mm
- 1/4" PH Screwdriver Socket PH1 | PH2
- 1/4" PZ Screwdriver Socket PZ1 | PZ2
- 1/4" Screwdriver Socket 4 | 5,5 | 7 mm
- 1/4" Inside Hexagon Screwdriver Socket 3 | 4 | 5 | 6 mm
- 1/4" TR Screwdriver Socket TR8 | TR10 | TR15 | TR20 | TR25 | TR27 | TR30
- 1/4" Universal Joint
- 1/4" Extension Bar 50 | 100 mm
- 1/4" Sliding Adaptor 3/8" x 1/4"
- 1/4" Spinner Handle with 1/4" Square Coupler
- 1/4" Reversible Ratchet, 43 teeth 140 mm
- 1/2" Socket, 6-point 10 | 11 | 12 | 13 | 14 | 15 | 16 | 17 | 18 | 19 | 21 | 22 | 24 | 27 | 30 | 32 | 34 mm
- 1/2" Spark Plug Socket 16 | 21 mm
- 1/2" Universal Joint
- 1/2" Extension Bar 75 | 250 mm
- 1/2" Sliding T-Adaptor 3/8" x 1/2"
- 1/2" Reversible Ratchet, 45 teeth 250 mm
- Hexagon Key Wrench 1,25 | 1,5 | 2 | 2,5 | 3 mm

Art.-No.	H x B x T (mm) H x W x L (mm)		
9291633	78 x 463 x 272	5242	1

Einzelteile entsprechen der DIN | parts according to DIN

DURCHSTECK- STECKSCHLÜSSEL- GARNITUR

Chrom-Vanadium Stahl | verchromt

- **Verwendbar für 5 verschiedene Spezialprofile: Vier-, Sechs- und Zwölfkant sowie Torx und Spline**
- **Selbst für verschlissene Sechskant-Schrauben**
- **Knarre, Einsätze und Verlängerung mit durchgehender Bohrung**
- **Zum Bewegen von Muttern auf langen Bolzen und Gewindestangen**
- **Mit Multifunktionsnüssen für 137 Anwendungen**
- **Universell einsetzbar**
- **Metrische und zöllige Schlüsselweiten**
- **Mit Adaptern für herkömmliche Steckschlüssel-Einsätze**
- **Mit Adaptern zur Nutzung mit Standard-Vierkant-Knarren**
- **Lieferbar im TANOS-systainer® oder in der L-BOXX®**

GO-THROUGH SOCKET SET

Chrome-Vanadium steel | chrome plated

- Suitable for 5 different special profiles: 4-, 6- and 12-point and Torx and Spline
- Even for worn hexagon screws
- Ratchet, Sockets and Extension Bar with through hole
- To move nuts on long bolts and threaded rods
- With multifunction sockets for 137 applications
- Universally applicable
- Metric and imperial wrench sizes
- With adaptors for conventional sockets
- With adaptors for standard square drive ratchets
- Available in TANOS-systainer® or in the L-BOXX®

**MM & INCH
137 GRÖSSEN
IN EINER BOX**

**MM & INCH
137 SIZES
IN ONE BOX**

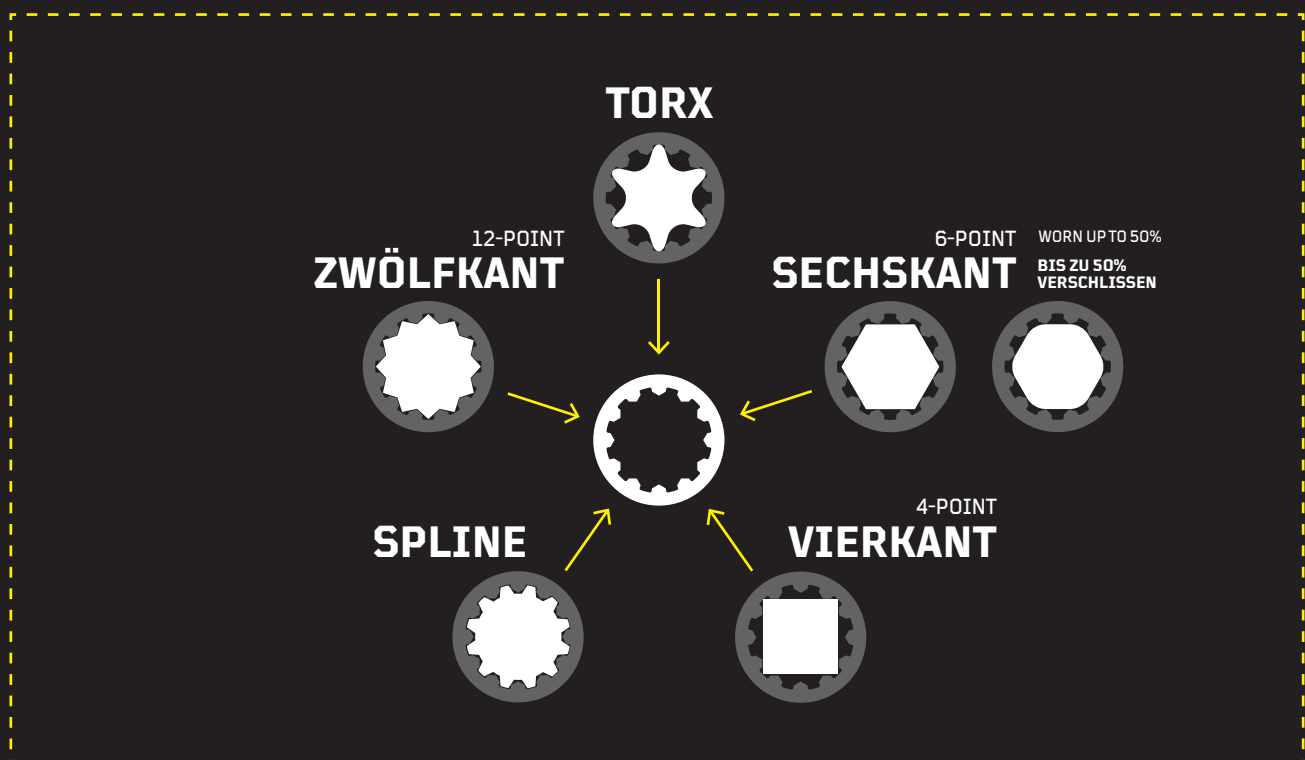



ALLESKÖNNER
ALLROUNDER

	4,5 mm	5 mm	5,5 mm	6 mm	7 mm	8 mm	9 mm	10 mm	11 mm	12 mm	13 mm	14 mm	15 mm	16 mm	17 mm	18 mm	19 mm	20 mm	21 mm	22 mm	23 mm	24 mm
	3/16"	13/16"	7/32"	1/4"	9/32"	5/16"	11/32"	3/8"	7/17"	15/32"	1/2"	9/16"	19/32"	5/8"	11/16"	23/32"	3/4"	25/32"	13/16"	7/8"	29/32"	15/16"
	4,5 mm	5 mm	5,5 mm	6 mm	7 mm	8 mm	9 mm	10 mm	11 mm	12 mm	13 mm	14 mm	15 mm	16 mm	17 mm	18 mm	19 mm	20 mm	21 mm	22 mm	23 mm	24 mm
	3/16"	13/16"	7/32"	1/4"	9/32"	5/16"	11/32"	3/8"	7/17"	15/32"	1/2"	9/16"	19/32"	5/8"	11/16"	23/32"	3/4"	25/32"	13/16"	7/8"	29/32"	15/16"
		M6		M8		M10		M12	M14		M16	M18		M20		M22	M24		M26	M28		M30
	E6			E8		E10		E12	E14	E16		E18		E20		E22	E24		E26	E28		E30
		4	4,5	5				8	9	10			12	13	14			16	17	18		19

	4 mm	5 mm	6 mm		T10	T15		PH1	PH2		3 mm	4 mm	6 mm
--	------	------	------	--	-----	-----	--	-----	-----	--	------	------	------



366

DURCHSTECK-STECKSCHLÜSSEL-EINSATZ GO-THROUGH SOCKET

Chrom-Vanadium Stahl
verchromt

Chrome-Vanadium steel
chrome plated

Art.-No.	Für For	Ø mm	l-mm-l	g	
9302913	371 - 13 mm	4,5	25	16	10
9302923	371 - 13 mm	5	25	17	10
9302933	371 - 13 mm	5,5	25	18	10
9302943	371 - 13 mm	6	25	16	10
9302953	371 - 13 mm	7	25	16	10
9302963	371 - 13 mm	8	25	16	10
9302973	371 - 13 mm	9	25	15	10
9302983	371 - 13 mm	10	25	15	10
9302993	371 - 13 mm	11	25	14	10
9303003	371 - 19 mm	10	30	42	10
9303013	371 - 19 mm	11	30	40	10
9303023	371 - 19 mm	12	30	40	10
9303033	371 - 19 mm	13	30	38	10
9303043	371 - 19 mm	14	30	36	10
9303053	371 - 19 mm	15	30	35	10
9303063	371 - 19 mm	16	30	38	10
9303073	371 - 19 mm	17	30	34	10
9303083	371 - 19 mm	18	30	40	10
9303093	371 - 19 mm	19	30	36	10
9303103	371 - 22 mm	19	38	54	10
9303113	371 - 22 mm	20	38	74	10
9303123	371 - 22 mm	21	39	71	10
9303133	371 - 22 mm	22	38	67	10
9303143	371 - 22 mm	23	40	79	10
9303153	371 - 22 mm	24	42	75	10



383

DURCHSTECK-STECKSCHLÜSSEL-ADAPTER GO-THROUGH SOCKET ADAPTOR

Chrom-Vanadium Stahl
verchromt

Chrome-Vanadium steel
chrome plated

Art.-No.	Ø AF"	Ø mm	l-mm-l	g	
9303223	1/4"	13	25	21	10
9303233	3/8"	19	30	57	10
9303243	1/2"	22	40	95	10



381

DURCHSTECK-STECKSCHLÜSSEL-VERLÄNGERUNG GO-THROUGH SOCKET EXTENSION

Chrom-Vanadium Stahl
verchromt

Chrome-Vanadium steel
chrome plated

Art.-No.	Für For	l-mm-l	g	
9303193	371 - 13 mm	75	48	10
9303203	371 - 19 mm	75	107	10
9303213	371 - 22 mm	75	123	10





382

DURCHSTECK-STECKSCHLÜSSEL-ADAPTER GO-THROUGH SOCKET ADAPTOR



Chrom-Vanadium Stahl
verchromt

Chrome-Vanadium steel
chrome plated

Art.-No.	mm	"	l-mm-l	g	
9303253	13	1/4"	22	19	10
9303263	19	3/8"	28	49	10
9303273	22	1/2"	35	81	10



371

DURCHSTECK-HEBELUMSCHALTKNARRE, 72 ZÄHNE GO-THROUGH RATCHET, LEVER TYPE, 72 TEETH

Chrom-Vanadium Stahl
verchromt

Chrome-Vanadium steel
chrome plated

Art.-No.	72	AF"	mm	l-mm-l	g	
9303163	72	1/4"	13	150	115	10
9303173	72	3/8"	19	200	276	10
9303183	72	1/2"	22	250	491	10



3990

STECKSCHLÜSSEL-GARNITUR IM TANOS-SYSTAINER® GO-THROUGH SOCKET SET IN TANOS-SYSTAINER®

Chrom-Vanadium Stahl
verchromt
47-tlg.
mit Multifunktionsnüssen für 137 Anwendungen
im original TANOS-systainer®

Durchsteck-Hebelumschaltknarre 1/4" | 3/8" | 1/2" (13 | 19 | 22 mm)
Verlängerung 1/4" | 3/8" | 1/2" (13 | 19 | 22 mm), Länge 75 mm
Adapter auf 1/4" | 3/8" | 1/2"
Schnellwechsel-Adapter 4-kant auf 1/4" | 3/8" | 1/2"
Durchsteck-Steckschlüssel-Einsätze 1/4" (13 mm) 4,5 | 5 | 5,5 | 6 | 7 |
8 | 9 | 10 | 11 mm
Durchsteck-Steckschlüssel-Einsätze 3/8" (19 mm) 10 | 11 | 12 | 13 |
14 | 15 | 16 | 17 | 18 | 19 mm
Durchsteck-Steckschlüssel-Einsätze 1/2" (22 mm) 19 | 20 | 21 | 22 |
23 | 24 mm
1/4" PH Steckschlüssel-Einsatz PH1 | PH2
1/4" TX Steckschlüssel-Einsatz TX10 | TX15
1/4" Schraubendreher-Einsatz 3 | 4 | 6 mm
1/4" Innensechskant-Schraubendreher-Einsatz 4 | 5 | 6 mm



Chrome-Vanadium steel
chrome plated
47 pcs.
with multifunction sockets for 137 applications
in the original TANOS-systainer®

Go-Through Reversible Lever Ratchet 1/4" | 3/8" | 1/2" (13 | 19 | 22 mm)
Extension Bar 1/4" | 3/8" | 1/2" (13 | 19 | 22 mm), length 75 mm
Adaptor to 1/4" | 3/8" | 1/2"
Quick-release Square Adaptor to 1/4" | 3/8" | 1/2"
Go-Through Sockets 1/4" (13 mm) 4,5 | 5,5 | 5 | 6 | 7 |
8 | 9 | 10 | 11 mm
Go-Through Sockets 3/8" (19 mm) 10 | 11 | 12 | 13 |
14 | 15 | 16 | 17 | 18 | 19 mm
Go-Through Sockets 1/2" (22 mm) 19 | 20 | 21 | 22 |
23 | 24 mm
1/4" PH Screwdriver Socket PH1 | PH2
1/4" TX Screwdriver Socket TX10 | TX15
1/4" Screwdriver Socket 3 | 4 | 6 mm
1/4" Inside Hexagon Screwdriver Socket 4 | 5 | 6 mm

Art.-No.	L x B x H (mm) L x W x H (mm)		
3990003	395 x 295 x 105	4600	1

Einzelteile entsprechen der DIN | parts according to DIN



3992

STECKSCHLÜSSEL-GARNITUR IN L-BOXX® GO-THROUGH SOCKET SET IN L-BOXX®



Chrom-Vanadium Stahl
verchromt
47-tlg.
mit Multifunktionsnüssen für 137 Anwendungen
in der original L-BOXX®

- Durchsteck-Hebelumschaltknarre 1/4" | 3/8" | 1/2" (13 | 19 | 22 mm)
- Verlängerung 1/4" | 3/8" | 1/2" (13 | 19 | 22 mm), Länge 75 mm
- Adapter auf 1/4" | 3/8" | 1/2"
- Schnellwechsel-Adapter 4-kant auf 1/4" | 3/8" | 1/2"
- Durchsteck-Steckschlüssel-Einsätze 1/4" (13 mm) 4.5 | 5 | 5.5 | 6 | 7 | 8 | 9 | 10 | 11 mm
- Durchsteck-Steckschlüssel-Einsätze 3/8" (19 mm) 10 | 11 | 12 | 13 | 14 | 15 | 16 | 17 | 18 | 19 mm
- Durchsteck-Steckschlüssel-Einsätze 1/2" (22 mm) 19 | 20 | 21 | 22 | 23 | 24 mm
- 1/4" PH Steckschlüssel-Einsatz PH1 | PH2
- 1/4" TX Steckschlüssel-Einsatz TX10 | TX15
- 1/4" Schraubendreher-Einsatz 3 | 4 | 6 mm
- 1/4" Innensechskant-Schraubendreher-Einsatz 4 | 5 | 6 mm



Chrome-Vanadium steel
chrome plated
47 pcs.
with multifunction sockets for 137 applications
in the original L-BOXX®

- Go-Through Reversible Lever Ratchet 1/4" | 3/8" | 1/2" (13 | 19 | 22 mm)
- Extension Bar 1/4" | 3/8" | 1/2" (13 | 19 | 22 mm), length 75 mm
- Adaptor to 1/4" | 3/8" | 1/2"
- Quick-release Square Adaptor to 1/4" | 3/8" | 1/2"
- Go-Through Sockets 1/4" (13 mm) 4.5 | 5.5 | 5 | 6 | 7 | 8 | 9 | 10 | 11 mm
- Go-Through Sockets 3/8" (19 mm) 10 | 11 | 12 | 13 | 14 | 15 | 16 | 17 | 18 | 19 mm
- Go-Through Sockets 1/2" (22 mm) 19 | 20 | 21 | 22 | 23 | 24 mm
- 1/4" PH Screwdriver Socket PH1 | PH2
- 1/4" TX Screwdriver Socket TX10 | TX15
- 1/4" Screwdriver Socket 3 | 4 | 6 mm
- 1/4" Inside Hexagon Screwdriver Socket 4 | 5 | 6 mm

Art.-No.	L x B x H (mm) L x W x H (mm)		
3992000	445 x 355 x 120	5203	1

Einzelteile entsprechen der DIN | parts according to DIN



440



STECKSCHLÜSSEL-EINSATZ, 6-KANT, DIN 3124
SOCKET, 6-POINT, DIN 3124

DIN 3120 D, ISO 1174-1,
ISO 2725-1
Chrom-Vanadium Stahl
verchromt

DIN 3120 D, ISO 1174-1,
ISO 2725-1
Chrome-Vanadium steel
chrome plated

Art.-No.	Ø mm	l mm	g	Box
9223763	19	50	172	5
9223773	22	50	218	5
9220053	24	51	224	5
9215043	27	52	234	5
9215053	30	52	290	5
9215063	32	55	316	5
9300673	34	57	316	5
9215073	36	57	432	5
9267183	38	60	414	5
9215083	41	63	508	5
9215093	46	68	684	5
9215103	50	72	838	5
9225043	55	76	973	1
9215113	60	78	1086	1

445



STECKSCHLÜSSEL-EINSATZ, 12-KANT, DIN 3124
SOCKET, 12-POINT, DIN 3124

DIN 3120 D, ISO 1174-1,
ISO 2725-1
Chrom-Vanadium Stahl
verchromt

DIN 3120 D, ISO 1174-1,
ISO 2725-1
Chrome-Vanadium steel
chrome plated

Art.-No.	Ø mm	l mm	g	Box
44501903	19	50	215	5
44502103	21	50	216	5
44502203	22	52	220	5
44502403	24	52	220	5
44502703	27	54	226	5
44503003	30	55	300	5
44503203	32	56	294	5
44503403	34	58	344	5
44503603	36	58	340	5
44503803	38	60	340	5
44504103	41	58	542	5
44504603	46	60	696	5
44505003	50	68	866	5



443



VERLÄNGERUNG, DIN 3123 B
EXTENSION BAR, DIN 3123 B

DIN 3120 A/C, ISO 1174-1,
ISO 3316
Chrom-Vanadium Stahl
verchromt

DIN 3120 A/C, ISO 1174-1,
ISO 3316
Chrome-Vanadium steel
chrome plated

Art.-No.	l mm	g	Box
9215133	200	693	1
9215143	400	1319	1

442



GRIF MIT GLEITSTÜCK, DIN 3122 A
SLIDING T-HANDLE, DIN 3122 A

DIN 3120 A/C, ISO 1174-1,
ISO 3315
Chrom-Vanadium Stahl
verchromt

DIN 3120 A/C, ISO 1174-1,
ISO 3315
Chrome-Vanadium steel
chrome plated

Art.-No.	l mm	g	Box
9215153	450	1391	1



438

ÜBERGANGSTEIL, DIN 3123 A
ADAPTOR, DIN 3123 A



DIN 3120 A/C, ISO 1174-1,
ISO 3316
Chrom-Vanadium Stahl
verchromt
3/4" innen, 1/2" außen

DIN 3120 A/C, ISO 1174-1,
ISO 3316
Chrome-Vanadium steel
chrome plated
3/4" female, 1/2" male

Art.-No.	l-mm-l		
9215173	58	176	5

437

ÜBERGANGSTEIL, DIN 3123 A
ADAPTOR, DIN 3123 A



DIN 3120 A/C, ISO 1174-1,
ISO 3316
Chrom-Vanadium Stahl
verchromt
3/4" innen, 1" außen

DIN 3120 A/C, ISO 1174-1,
ISO 3316
Chrome-Vanadium steel
chrome plated
3/4" female, 1" male

Art.-No.	l-mm-l		
9215163	60	362	5



447

VERBINDUNGSVIERKANT, DIN 3122
SQUARE COUPLER, DIN 3122



DIN 3120 A, ISO 1174-1
Chrom-Vanadium Stahl
verchromt

DIN 3120 A, ISO 1174-1
Chrome-Vanadium steel
chrome plated

Art.-No.	l-mm-l		
9224923	50	118	10



444

HEBELUMSCHALTKNARRE, 24 ZÄHNE, DIN 3122 D
REVERSIBLE RATCHET, 24 TEETH, DIN 3122 D



DIN 3120 A, ISO 1174-1,
ISO 3315 A
Chrom-Vanadium-Stahl
verchromt

DIN 3120 A, ISO 1174-1,
ISO 3315 A
Chrome Vanadium steel
chrome plated

Art.-No.		l-mm-l		
9272434	24	500	2643	5



441

KNARRE UMSTECKBAR, 36 ZÄHNE, DIN 3122 C
PUSH-THROUGH RATCHET, 36 TEETH, DIN 3122 C



DIN 3120 A/C, ISO 1174-1,
ISO 3315
Chrom-Vanadium Stahl
verchromt
Kunststoffheft
mit Verbindungsvierkant

DIN 3120 A/C, ISO 1174-1,
ISO 3315
Chrome-Vanadium steel
chrome plated
plastic handle
with square coupler

Art.-No.		l-mm-l		
9215183	36	500	1500	1

446

UMSCHALTKNARRE, 60 ZÄHNE, DIN 3122 D
REVERSIBLE RATCHET, 60 TEETH, DIN 3122 D



DIN 3120 A, ISO 1174-1,
ISO 3315
Chrom-Vanadium Stahl
verchromt
Kunststoffheft

DIN 3120 A, ISO 1174-1,
ISO 3315
Chrome-Vanadium steel
chrome plated
plastic handle

Art.-No.		l-mm-l		
9215193	60	485	1570	1



449

STECKSCHLÜSSEL-GARNITUR SOCKET SET

Chrom-Vanadium Stahl | verchromt | 15-tlg. im Stahlblechkasten

Steckschlüssel-Einsatz, 6-kant 22 | 24 | 27 | 30 | 32 | 34 | 36 | 38 | 41 | 46 | 50 mm
Verlängerung 200 | 400 mm
Griff mit Gleitstück 430 mm
Knarre, umsteckbar, 36 Zähne 500 mm



Chrome-Vanadium steel | chrome plated | 15 pcs. in metal box

Socket, 6-point 22 | 24 | 27 | 30 | 32 | 34 | 36 | 38 | 41 | 46 | 50 mm
Extension Bar 200 | 400 mm
Sliding T-Handle 430 mm
Push-Through Ratchet, 36 teeth 500 mm

Art.-No.	H x B x T (mm) H x W x L (mm)		
9223793	575 x 235 x 95	11500	1

Einzelteile entsprechen der DIN | parts according to DIN



448

STECKSCHLÜSSEL-GARNITUR SOCKET SET

Chrom-Vanadium Stahl | verchromt | 14-tlg. im Stahlblechkasten

Steckschlüssel-Einsatz, 12-kant 22 | 24 | 27 | 30 | 32 | 36 | 38 | 41 | 46 | 50 mm
Verlängerung 200 | 400 mm
Griff mit Gleitstück 430 mm
Knarre, umsteckbar, 36 Zähne 500 mm



Chrome-Vanadium steel | chrome plated | 14 pcs. in metal box

Socket, 12-point 22 | 24 | 27 | 30 | 32 | 36 | 38 | 41 | 46 | 50 mm
Extension Bar 200 | 400 mm
Sliding T-Handle 430 mm
Push-Through Ratchet, 36 teeth 500 mm

Art.-No.	H x B x T (mm) H x W x L (mm)		
9223463	575 x 235 x 95	10500	1

Einzelteile entsprechen der DIN | parts according to DIN



**54-TEILIG
METRISCH UND ZÖLLIG
VON 4 BIS 46 MM**

54 PCS.
METRIC AND IMPERIAL
FROM 4 TO 46 MM

3980

STECKSCHLÜSSEL-GARNITUR SOCKET SET

Chrom-Vanadium Stahl | verchromt
54-tlg. | im Kunststoffkoffer

- 1/4" Hebelumschaltknarre, 72 Zähne, 160 mm
- 1/4" Steckschlüssel-Einsatz, 6-kant 4 | 5 | 6 | 7 | 8 | 9 | 10 mm
- 1/4" Steckschlüssel-Einsatz, 6-kant 3/16" | 1/4" | 3/8"
- 1/4" Verlängerung 50 | 100 mm
- 1/4" Griff mit Gleitstück 110 mm
- 1/4" Kardan-Gelenk
- 1/4" Steckgriff mit 1/4" Antriebsvierkant
- 1/4" Gelenkgriff 13 x 135 mm mit 7 mm Loch
Drehstift 6,35 x 110 mm

- 1/2" Hebelumschaltknarre, 72 Zähne, 260 mm
- 1/2" Steckschlüssel-Einsatz, 6-kant 10 | 11 | 12 | 13 | 14 | 15 | 16 | 17 | 18 | 19 | 20 | 21 | 22 | 24 | 26 | 27 | 30 | 32 mm
- 1/2" Steckschlüssel-Einsatz, 6-kant 9/16" | 11/16" | 3/8" | 1/2" | 1"
- 1/2" Verlängerung 125 | 250 mm
- 1/2" Griff mit Gleitstück 250 mm
- 1/2" Kardan-Gelenk
- 1/2" Gelenkgriff 20 x 380 mm mit 13 mm Loch
Drehstift 12 x 150 mm

- 3/4" Hebelumschaltknarre, 24 Zähne, 490 mm
2000 Nm Drehmoment garantiert!
- 3/4" Steckschlüssel-Einsatz, 6-kant 36 | 38 | 41 | 46 mm
- 3/4" Verlängerung 200 mm





Chrome-Vanadium steel | chrome plated
54 pcs. | in plastic case

- 1/4" Reversible Ratchet, 72 teeth, 160 mm
- 1/4" Socket, 6-point 4 | 5 | 6 | 7 | 8 | 9 | 10 mm
- 1/4" Socket, 6-point 6-kant 3/16" | 1/4" | 3/8"
- 1/4" Extension Bar 50 | 100 mm
- 1/4" Sliding T-Handle 110 mm
- 1/4" Universal Joint
- 1/4" Spinner Handle with 1/4" Square Coupler
- 1/4" Flexible Handle 13 x 135 mm with 7 mm hole
Tommy Bar 6,35 x 110 mm

- 1/2" Reversible Ratchet, 72 teeth, 260 mm
- 1/2" Socket, 6-point 10 | 11 | 12 | 13 | 14 | 15 | 16 | 17 | 18 | 19 | 20 | 21 | 22 | 24 | 26 | 27 | 30 | 32 mm
- 1/2" Socket, 6-point 9/16" | 11/16" | 3/8" | 1/2" | 1"
- 1/2" Extension Bar 125 | 250 mm
- 1/2" Sliding T-Handle 250 mm
- 1/2" Universal Joint
- 1/2" Flexible Handle 20 x 380 mm with 13 mm hole
Tommy bar adapting to flexible-handle, 12 x 150 mm

- 3/4" Reversible Ratchet, 24 teeth, 490 mm
2000 Nm Torque guaranteed!
- 3/4" Socket, 6-point 36 | 38 | 41 | 46 mm
- 3/4" Extension Bar 200 mm

Art.-No.	H x B x T (mm) H x W x L (mm)		
39800003	110 x 460 x 382	12500	1

Einzelteile entsprechen der DIN | parts according to DIN

**METRISCH UND ZÖLLIG
VON 4 BIS 46 MM**

METRIC AND IMPERIAL
FROM 4 TO 46 MM

3980 D

**DISPLAY STECKSCHLÜSSEL-
GARNITUREN**
DISPLAY SOCKET SETS

Chrom-Vanadium-Stahl
verchromt
10 Steckschlüssel-Garnituren

Chrome Vanadium steel
chrome plated
10 Socket Sets



STECKSCHLÜSSEL-EINSÄTZE
BETÄTIGUNGSWERKZEUGE, GARNITUREN
SOCKETS & ACCESSORIES, SOCKET SETS

04

Art.-No.	H x B x T (mm) H x W x L (mm)	kg	☐
39800103	1250 x 600 x 400	125	1

Einzelteile entsprechen der DIN | parts according to DIN





5014

25 1" 

STECKSCHLÜSSEL-EINSATZ, 12-KANT, DIN 3124
SOCKET, 12-POINT, DIN 3124

DIN 3120 B, ISO 1174-1,
ISO 2725-1
mit Stiftsicherung
Chrom-Vanadium Stahl
verchromt

DIN 3120 B, ISO 1174-1,
ISO 2725-1
with retaining pin
Chrome-Vanadium steel
chrome plated

Art.-No.	 mm	l-mm-l		
9249013	36	70	482	5
9249023	38	74	483	5
9249033	41	74	558	5
9249043	46	76	804	1
9249053	50	80	890	1
9245483	55	84	1114	1
9249063	60	87	1334	1
9249073	65	92	1478	1
9249083	70	96	1848	1
9249093	75	100	2060	1
9249103	80	107	2254	1





5120

25 1"  

VERLÄNGERUNG, DIN 3123 B
EXTENSION BAR, DIN 3123 B

DIN 3120 B/D, ISO 1174-1,
ISO 3316
mit Stiftsicherung
Chrom-Vanadium Stahl
verchromt

DIN 3120 B/D, ISO 1174-1,
ISO 3316
Chrome-Vanadium steel
chrome plated

Art.-No.	l-mm-l		
9249123	200	1124	1
9249133	400	1900	1



5220

25 1" 

20 3/4" 

ÜBERGANGSTEIL, DIN 3123 A
ADAPTOR, DIN 3123 A

DIN 3120 B/D, ISO 1174-1,
ISO 3316
mit Stiftsicherung
Chrom-Vanadium Stahl
verchromt
1" innen, 3/4" außen

DIN 3120 B/D, ISO 1174-1,
ISO 3316
with retaining pin
Chrome-Vanadium steel
chrome plated
1" female, 3/4" male

Art.-No.	l-mm-l		
9249143	80	465	1

5160

25 1"  

GRIFF MIT GLEITSTÜCK, DIN 3122 A
SLIDING T-HANDLE, DIN 3122 A

DIN 3120 A, ISO 1174-1,
ISO 3315
mit Stiftsicherung
Chrom-Vanadium Stahl
verchromt

DIN 3120 A, ISO 1174-1,
ISO 3315
with retaining pin
Chrome-Vanadium steel
chrome plated

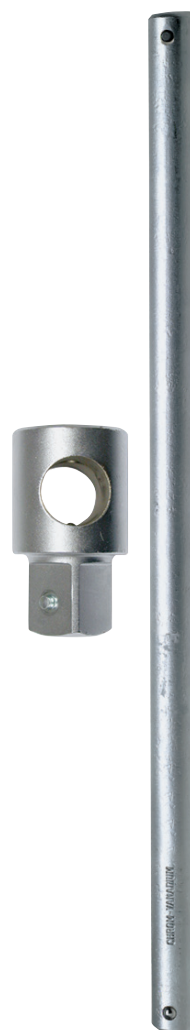

Art.-No.	l-mm-l		
9224313	510	2472	1





5260

UMSCHALTKNARRE, 60 ZÄHNE, DIN 3122 D
REVERSIBLE RATCHET, 60 TEETH, DIN 3122 D

DIN 3120 A, ISO 1174-1, ISO 3315 A
Chrom-Vanadium Stahl
verchromt
mit Gleitstab

25 1" 

DIN 3120 A, ISO 1174-1, ISO 3315 A
Chrome-Vanadium steel
chrome plated
with sliding bar

Art.-No.		l-mm-l		
9249113	60	645	4608	1



5900

STECKSCHLÜSSEL-GARNITUR SOCKET SET

Chrom-Vanadium Stahl
verchromt
11-tlg. im Stahlblechkasten

Steckschlüssel-Einsatz, 12-kant 36 | 41 | 46 | 50 | 55 | 60 | 65 | 70 mm
Verlängerung 210 | 420 mm
Knarre, umschaltbar, 60 Zähne 610 mm



Chrome-Vanadium steel
chrome plated
11 pcs. in metal box

Socket, 12-point 36 | 41 | 46 | 50 | 55 | 60 | 65 | 70 mm
Extension Bar 210 | 420 mm
Reversible Ratchet, 60 teeth 610 mm

Art.-No.	H x B x T (mm) H x W x L (mm)		
9229043	550 x 245 x 110	19600	1

Einzelteile entsprechen der DIN | parts according to DIN

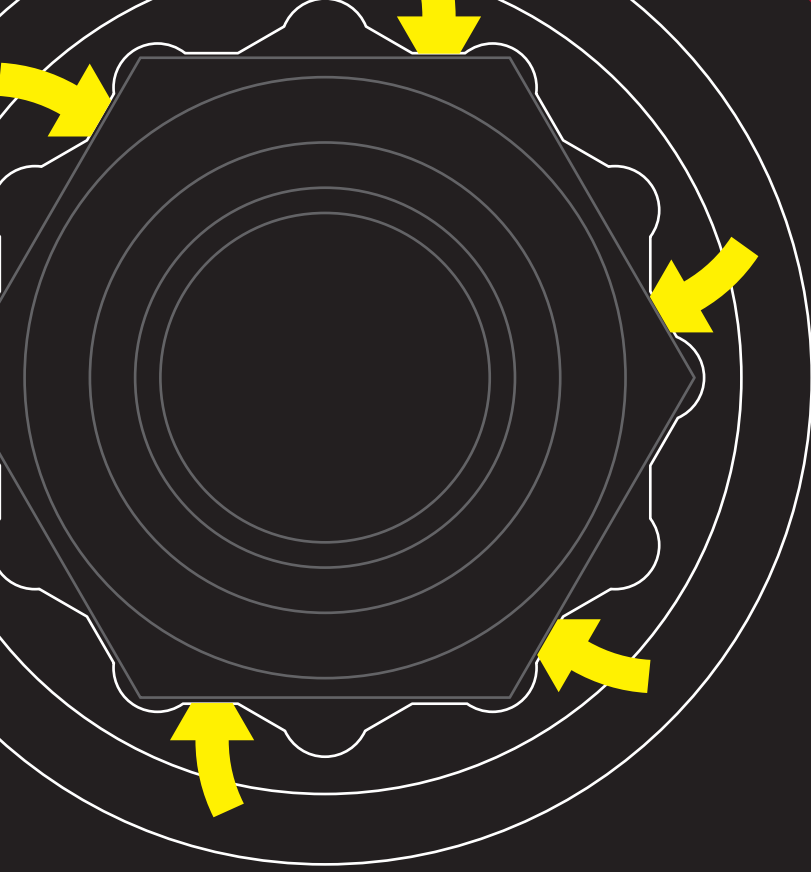

KRAFT-EINSÄTZE

Hundertfache Drehvorgänge pro Stunde — oft unter erschwerten Bedingungen. Wo Kraft-Einsätze verwendet werden, geht es ordentlich zur Sache.

Doch selbst bei härtesten Belastungen muss eine sichere und benutzerfreundliche Handhabung gewährleistet sein. Hier kann die ausgereifte WGB-Werkzeugtechnologie ihre Überlegenheit ausspielen. Hochwertiger Stahl und modernste Fertigungstechnik schaffen ein Produkt, das ein Höchstmaß an Sicherheit, Langlebigkeit und Komfort bietet. Mit WGB-Kraft-Einsätzen bist du immer bestens gerüstet.

IMPACT SOCKET

Hundreds of turning processes per hour — often under very difficult conditions. The going really gets tough, whenever impact sockets are being used.

Nevertheless, safe and user-friendly handling must be guaranteed even under the hardest conditions. This is where sophisticated WGB tool technology can really demonstrate its superiority. High-quality steel and state-of-the-art production technology create a product which offers the highest standard of safety, longevity and comfort. You are always ahead of the game with WGB impact sockets.

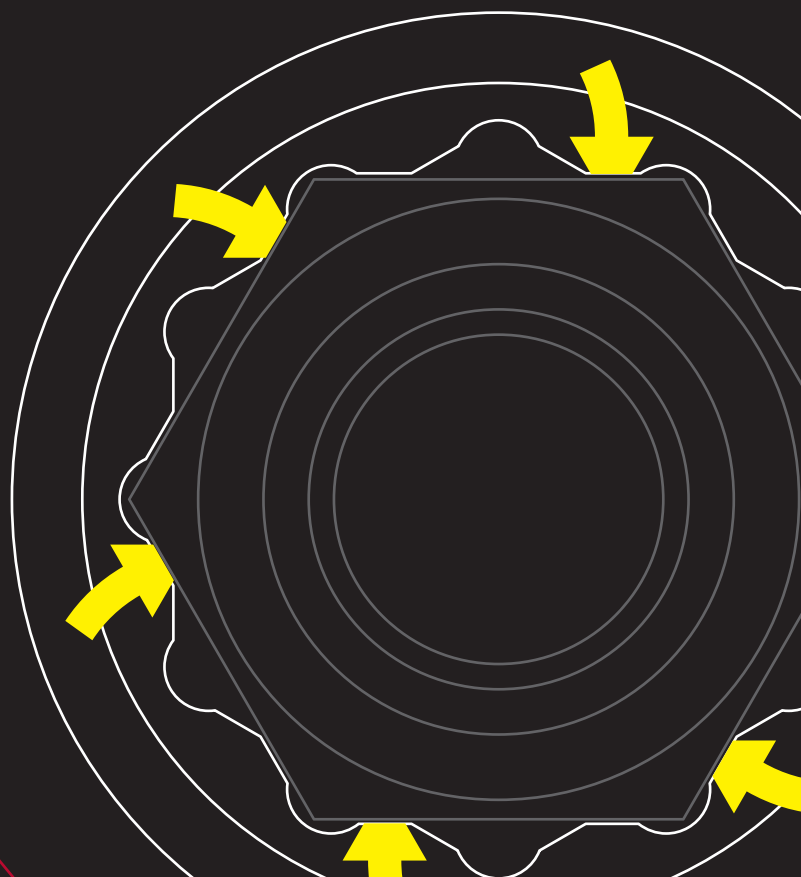



1310

6,3 1/4"

KRAFT-EINSATZ, 6-KANT, DIN 3129
IMPACT SOCKET, 6-POINT, DIN 3129

DIN 3121
Chrom-Molybdän Stahl
schwarz

DIN 3121
Chrome-Molybdenum steel
black

Art.-No.	mm	l-mm-l	g	
13100401	4	23	14	10
13100451	4,5	23	14	10
13100501	5	23	14	10
13100551	5,5	23	16	10
13100601	6	23	16	10
13100701	7	23	15	10
13100801	8	23	15	10
13100901	9	23	16	10
13101001	10	23	16	10
13101101	11	23	18	10
13101201	12	23	19	10
13101301	13	23	21	10
13101401	14	23	23	10

1311

6,3 1/4"

KRAFT-VERLÄNGERUNG
IMPACT EXTENSION BAR

DIN 3121
Chrom-Molybdän Stahl
schwarz

DIN 3121
Chrome-Molybdenum steel
black

Art.-No.	l-mm-l	g	
9234811	50	25	10



1312

6,3 1/4"

10 3/8"

KRAFT-ÜBERGANGSTEIL
IMPACT ADAPTOR

DIN 3121
1/4" innen, 3/8" außen
Chrom-Molybdän Stahl
schwarz

DIN 3121
1/4" female, 3/8" male
Chrome-Molybdenum steel
black

Art.-No.	l-mm-l	g	
9234821	32	10	10



2310

10 3/8"

KRAFT-EINSATZ, 6-KANT, DIN 3129
IMPACT SOCKET, 6-POINT, DIN 3129

DIN 3121
Chrom-Molybdän Stahl
schwarz

DIN 3121
Chrome-Molybdenum steel
black

Art.-No.	mm	mm-l	g	
23100801	8	30	38	10
23100901	9	30	42	10
23101001	10	30	42	10
23101101	11	30	42	10
23101201	12	30	44	10
23101301	13	30	44	10
23101401	14	30	52	10
23101501	15	30	52	10
23101601	16	30	68	10
23101701	17	30	74	10
23101901	19	30	86	10
23102101	21	30	90	10

2318

10 3/8"

KRAFT-EINSATZ, 6-KANT, DIN 3129
IMPACT SOCKET, 6-POINT, DIN 3129

DIN 3121
lange Ausführung
Chrom-Molybdän Stahl
schwarz

DIN 3121
long type
Chrome-Molybdenum steel
black

Art.-No.	mm	mm-l	g	
23181001	10	63	62	10
23181201	12	62	73	10
23181401	14	63	102	10
23181701	17	63	134	10



2316

10 3/8"

STIFT FÜR KRAFT-EINSÄTZE UND VERBINDUNGSTEILE
LOCKING PIN FOR IMPACT SOCKETS AND CONNECTING PARTS

Chrom-Molybdän Stahl
schwarz

Chrome-Molybdenum steel
black

Art.-No.	mm	mm-l	g	
9266650	6-12	14	1	50
9266660	13-21	16	1	50

2317

10 3/8"

RING FÜR KRAFT-EINSÄTZE UND VERBINDUNGSTEILE
LOCKING RING FOR IMPACT SOCKETS AND CONNECTING PARTS

schwarz

black

Art.-No.	mm	g	
9266630	6-12	2	50
9266640	13-21	1	50

2311

KRAFT-VERLÄNGERUNG IMPACT EXTENSION BAR

10 3/8" □ □

DIN 3121
Chrom-Molybdän Stahl
schwarz

DIN 3121
Chrome-Molybdenum steel
black

Art.-No.	l-mm-l		
9236211	75	78	10
9243071	150	142	10



2314

KRAFT-ÜBERGANGSTEIL IMPACT ADAPTOR

10 3/8" □
6,3 1/4" □

DIN 3121
3/8" innen, 1/4" außen
Chrom-Molybdän Stahl
schwarz

DIN 3121
3/8" female, 1/4" male
Chrome-Molybdenum steel
black

Art.-No.	l-mm-l		
9243531	35	43	10

2315

KRAFT-ÜBERGANGSTEIL IMPACT ADAPTOR

10 3/8" □
12,5 1/2" □

DIN 3121
3/8" innen, 1/2" außen
Chrom-Molybdän Stahl
schwarz

DIN 3121
3/8" female, 1/2" male
Chrome-Molybdenum steel
black

Art.-No.	l-mm-l		
9234871	45	43	10



3310

KRAFT-EINSATZ, 6-KANT, DIN 3129
IMPACT SOCKET, 6-POINT, DIN 3129

DIN 3121
Chrom-Molybdän Stahl
schwarz

DIN 3121
Chrom-Molybdenum steel
black



3316

KRAFT-EINSATZ, 6-KANT, DIN 3129
IMPACT SOCKET, 6-POINT, DIN 3129

DIN 3121
lange Ausführung
Chrom-Molybdän Stahl
schwarz

DIN 3121
long type
Chrom-Molybdenum steel
black

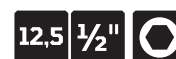

Art.-No.	Ø mm	l mm-l	g	☐
33100801	8	38	64	10
33100901	9	38	64	10
33101001	10	38	64	10
33101101	11	38	68	10
33101201	12	38	68	10
33101301	13	38	68	10
33101401	14	38	68	10
33101501	15	38	78	10
33101601	16	38	78	10
33101701	17	38	90	10
33101801	18	40	116	10
33101901	19	40	116	10
33102001	20	40	116	10
33102101	21	40	120	10
33102201	22	40	125	10
33102401	24	40	135	10
33102501	25	40	150	10
33102601	26	40	160	10
33102701	27	42	170	10
33102801	28	42	200	10
33103001	30	42	230	10
33103201	32	42	250	10
33103601	36	48	300	5
33103801	38	48	386	5

Art.-No.	Ø mm	l mm-l	g	☐
33160801	8	78	120	10
33160901	9	78	120	10
33161001	10	78	120	10
33161101	11	78	130	5
33161201	12	78	140	5
33161301	13	78	160	5
33161401	14	78	160	5
33161501	15	78	170	5
33161601	16	78	170	5
33161701	17	78	180	5
33161801	18	78	216	5
33161901	19	78	216	5
33162001	20	78	226	5
33162101	21	78	230	5
33162201	22	78	270	5
33162401	24	78	296	5
33162501	25	78	300	5
33162601	26	78	300	5
33162701	27	78	360	5
33162801	28	78	370	5
33163001	30	78	430	5
33163201	32	78	500	5
33163601	36	78	506	5
33163801	38	78	506	5



3363



INNENSECHSKANT-KRAFT-EINSATZ, 6-KANT
INSIDE HEXAGON IMPACT SOCKET, 6-POINT

DIN 3121
Chrom-Molybdän Stahl
schwarz

DIN 3121
Chrome-Molybdenum steel
black

Art.-No.	mm	l-mm-l	g	
33630401	4	78	84	10
33630501	5	78	84	10
33630601	6	78	84	10
33630801	8	78	92	10
33631001	10	78	104	10
33631201	12	78	120	10
33631401	14	78	144	10
33631701	17	78	173	10
33631901	19	78	200	10

3340



TX KRAFT-EINSATZ
TX IMPACT SOCKET

DIN 3121
Chrom-Molybdän Stahl
schwarz

DIN 3121
Chrome-Molybdenum steel
black

Art.-No.		l-mm-l	g	
33402001	TX20	78	74	10
33402501	TX25	78	76	10
33402701	TX27	78	78	10
33403001	TX30	78	78	10
33404001	TX40	78	86	10
33404501	TX45	78	92	10
33405001	TX50	78	96	10
33405501	TX55	78	110	10
33406001	TX60	78	122	10
33407001	TX70	78	136	10
33408001	TX80	78	150	10



3311



KRAFT-VERLÄNGERUNG
IMPACT EXTENSION BAR

DIN 3121
Chrom-Molybdän Stahl
schwarz

DIN 3121
Chrome-Molybdenum steel
black

* mit Kugel | ** mit Pin

* with ball | ** with pin

Art.-No.	l-mm-l		
9234851*	50	91	10
9304300**	50	111	10
9256311	75	136	10
9234861*	125	214	10
9268010*	175	130	10
9278690*	250	422	10

3312



KRAFT-KARDAN-GELENK
IMPACT UNIVERSAL JOINT

DIN 3121
Chrom-Molybdän Stahl
schwarz

DIN 3121
Chrome-Molybdenum steel
black

Art.-No.	l-mm-l		
9266500	65	145	5



3314



KRAFT-ÜBERGANGSTEIL
IMPACT ADAPTOR

DIN 3121
1/2" innen, 3/8" außen
Chrom-Molybdän Stahl | schwarz

DIN 3121
1/2" female, 3/8" male
Chrome-Molybdenum steel | black

Art.-No.	l-mm-l		
9237620	45	71	10

3315



KRAFT-ÜBERGANGSTEIL
IMPACT ADAPTOR

DIN 3121
1/2" innen, 3/4" außen
Chrom-Molybdän Stahl | schwarz

DIN 3121
1/2" female, 3/4" male
Chrome-Molybdenum steel | black

Art.-No.	l-mm-l		
9243541	50	120	10



3317



STIFT FÜR KRAFT-EINSÄTZE UND VERBINDUNGSTEILE
LOCKING PIN FOR IMPACT SOCKETS AND CONNECTING PARTS

Chrom-Molybdän Stahl | schwarz

Chrome-Molybdenum steel | black

Art.-No.	mm	l-mm-l		
9238390	8-14	20	1	50
9238400	15-33	25	1	50

3318



RING FÜR KRAFT-EINSÄTZE UND VERBINDUNGSTEILE
LOCKING RING FOR IMPACT SOCKETS AND CONNECTING PARTS

schwarz

black

Art.-No.	mm		
9238370	8-14	1	50
9238380	15-33	1	50



3319

12,5 1/2"

KRAFT-SCHONEINSATZ, 6-KANT, DIN 3129
PROTECTIVE IMPACT SOCKET, 6-POINT, DIN 3129

DIN 3121
lange Ausführung
Chrom-Molybdän Stahl
kunststoffummantelt

DIN 3121
long type
Chrome-Molybdenum steel
plastic coated

Art.-No.	mm	l-mm-l		
33191700	17	85	212	5
33191900	19	85	211	5
33192100	21	85	239	5

3319 KK

12,5 1/2"

KRAFT-SCHONEINSATZ-GARNITUR
PROTECTIVE IMPACT SOCKET SET

lange Ausführung
Chrom-Molybdän Stahl
kunststoffummantelt
3-tlg.
in Kunststoffkassette

long type
Chrome-Molybdenum steel
plastic coated
3 pcs.
in plastic case

Art.-No.	Inhalt Content	H x B x T (mm) H x W x L (mm)		
33190000	17 19 21	48 x 145 x 140	836	1

Einzelteile entsprechen der DIN | parts according to DIN



3316 MK

12,5 1/2"

KRAFT-EINSATZ-GARNITUR
IMPACT SOCKET SET

lange Ausführung
Chrom-Molybdän Stahl
schwarz
15-tlg. + 2x Ring + 2x Stift
im Stahlblechkasten
mit Ring und Stift

long type
Chrome-Molybdenum steel
black
15 pcs. + 2x ring + 2x pin
in metal box
with ring and pin

Art.-No.	mm	H x B x T (mm) H x W x L (mm)		
33160001	10 11 12 13 14 15 16 17 18 19 21 22 24 27 30	50 x 435 x 95	3896	1

Einzelteile entsprechen der DIN | parts according to DIN



3340 KK

TX KRAFT-SCHRAUBENDREHER-EINSATZ-GARNITUR
TX IMPACT SOCKET SET

DIN 3121
Chrom-Molybdän Stahl | schwarz
8-tlg. | in Kunststoffkassette

12,5 1/2"

DIN 3121
Chrome-Molybdenum steel | black
8 pcs. | in plastic case

Art.-No.	mm	H x B x T (mm) H x W x L (mm)		
33400001	TX30 TX40 TX45 TX50 TX55 TX60 TX70 TX80	38 x 250 x 120	1100	1



3363 KK

INNENSECHSKANT-KRAFT-GARNITUR
INSIDE HEXAGON IMPACT SOCKET SET

DIN 3121
Chrom-Molybdän Stahl
schwarz
8-tlg.
im Kunststoffkasten

DIN 3121
Chrome-Molybdenum steel
black
8 pcs.
in plastic case

12,5 1/2"

Art.-No.	No.	mm	H x B x T (mm) H x W x L (mm)		
33630001	3363KK/8	5 6 8 10 12 14 17 19	38 x 250 x 120	1278	1



3350

KRAFT-EINSATZ-GARNITUR, DIN 3129
IMPACT SOCKET SET, DIN 3129

DIN 3121
Chrom-Molybdän Stahl | schwarz
7-tlg. | in Kunststoffkassette

DIN 3121
Chrome-Molybdenum steel | black
7 pcs. | in plastic case

6,3 1/4" 12,5 1/2"

Kraft-Einsatz 13 | 17 | 19 | 21 | 24 mm
1/2" Bit-Adapter, 1/4" innen, 1/2" außen
1/2" Maschinen-Adapter, 1/4" innen,
1/2" außen

Impact Socket 13 | 17 | 19 | 21 | 24 mm
1/2" Bit Adaptor, 1/4" female, 1/2" male
1/2" Machinery Adaptor, 1/4" female,
1/2" male

Art.-No.	H x B x T (mm) H x W x L (mm)		
33500001	60 x 180 x 150	838	1



4310



KRAFT-EINSATZ, 6-KANT, DIN 3129
IMPACT SOCKET, 6-POINT, DIN 3129

DIN 3121
Chrom-Molybdän Stahl
schwarz

DIN 3121
Chrome-Molybdenum steel
black

Art.-No.	Ø mm	l mm-l	g	📦
43101701	17	52	300	10
43101801	18	52	283	10
43101901	19	52	310	10
43102101	21	52	310	10
43102201	22	52	320	10
43102401	24	52	330	10
43102601	26	52	350	10
43102701	27	52	360	10
43102801	28	54	380	10
43102901	29	54	400	10
43103001	30	54	430	10
43103201	32	54	470	10
43103301	33	57	480	10
43103401	34	57	500	10
43103501	35	57	520	10
43103601	36	57	540	5
43103801	38	57	580	5
43104101	41	57	620	5
43104601	46	62	760	5
43105001	50	68	900	5
43105501	55	62	1300	5
43106001	60	80	1600	5

4316



KRAFT-EINSATZ, 6-KANT, DIN 3129
IMPACT SOCKET, 6-POINT, DIN 3129

DIN 3121 | lange Ausführung
Chrom-Molybdän Stahl
schwarz

DIN 3121 | long type
Chrome-Molybdenum steel
black

Art.-No.	Ø mm	l mm-l	g	📦
4316171	17	90	552	5
4316181	18	95	620	5
4316191	19	95	582	5
4316211	21	95	638	5
4316221	22	95	634	5
4316241	24	95	672	5
4316271	27	95	723	5
4316301	30	95	695	5
4316321	32	95	804	5
4316331	33	95	568	5
4316341	34	95	749	5
4316361	36	95	822	5
4316411	41	95	941	5
4316461	46	95	1052	5
4316501	50	95	1266	5
4316551	55	95	1300	1
4316601	60	95	1419	1



4364



INNENSECHSKANT-KRAFT-EINSATZ, 6-KANT
INSIDE HEXAGON IMPACT SOCKET

DIN 3121
Chrom-Molybdän Stahl
schwarz

DIN 3121
Chrome-Molybdenum steel
black

Art.-No.	Ø mm	l mm-l	g	📦
43641201	12	100	510	5
43641401	14	100	520	5
43641701	17	100	540	5
43641901	19	100	600	1
43642201	22	100	620	1
43642401	24	100	690	1



4311

KRAFT-VERLÄNGERUNG
IMPACT EXTENSION BAR



DIN 3121
Chrom-Molybdän Stahl
schwarz

DIN 3121
Chrome-Molybdenum steel
black

Art.-No.	l-mm-l		
9243181	100	390	5
9243191	175	854	5
9254621	250	1180	5
9243201	400	1686	5

4312

KRAFT-KARDAN-GELENK
IMPACT UNIVERSAL JOINT



DIN 3121
Chrom-Molybdän Stahl
schwarz

DIN 3121
Chrome-Molybdenum steel
black

Art.-No.	l-mm-l		
9266510	105	660	5



4314

KRAFT-ÜBERGANGSTEIL
IMPACT ADAPTOR



DIN 3121
3/4" innen, 1/2" außen
Chrom-Molybdän Stahl
schwarz

DIN 3121
3/4" female, 1/2" male
Chrome-Molybdenum steel
black

Art.-No.	l-mm-l		
9243551	55	190	5

4315

KRAFT-ÜBERGANGSTEIL
IMPACT ADAPTOR



DIN 3121
3/4" innen, 1" außen
Chrom-Molybdän Stahl
schwarz

DIN 3121
3/4" female, 1" male
Chrome-Molybdenum steel
black

Art.-No.	l-mm-l		
9240031	60	426	5



4317

STIFT FÜR KRAFT-EINSÄTZE UND VERBINDUNGSTEILE
LOCKING PIN FOR IMPACT SOCKETS AND CONNECTING PARTS



Chrom-Molybdän Stahl
schwarz

Chrome-Molybdenum steel
black

Art.-No.		l-mm-l		
9247540	13-46	36	3	20
9305100	60	54	8	20

4318

RING FÜR KRAFT-EINSÄTZE UND VERBINDUNGSTEILE
LOCKING RING FOR IMPACT SOCKETS AND CONNECTING PARTS



schwarz

black

Art.-No.			
9247550	13-46	4	20
9305110	60	5	20



5310



KRAFT-EINSATZ, 6-KANT, DIN 3129
IMPACT SOCKET, 6-POINT, DIN 3129

DIN 3121
Chrom-Molybdän Stahl
schwarz

DIN 3121
Chrome-Molybdenum steel
black

Art.-No.	mm	l-mm-l	g	
53102201	22	60	502	1
53102401	24	60	518	1
53102701	27	60	556	1
53103001	30	60	578	1
53103201	32	63	639	1
53103301	33	63	698	1
53103401	34	63	704	1
53103601	36	67	761	1
53103801	38	67	824	1
53104101	41	70	822	1
53104201	42	70	780	1
53104601	46	70	1016	1
53105001	50	70	1840	1
53105501	55	75	1300	1
53105601	56	85	1060	1
53106001	60	76	1444	1
53106501	65	76	1722	1
53107001	70	76	2063	1
53107501	75	80	3200	1
53108001	80	86	3300	1
53108501	85	90	3800	1
53109001	90	105	4398	1

5316



KRAFT-EINSATZ, 6-KANT, DIN 3129
IMPACT SOCKET, 6-POINT, DIN 3129

DIN 3121
lange Ausführung
Chrom-Molybdän Stahl
schwarz

DIN 3121
long type
Chrome-Molybdenum steel
black

Art.-No.	mm	l-mm-l	g	
53162401	24	90	730	5
53162601	26	80	580	5
53162701	27	90	796	5
53162901	29	80	600	5
53163001	30	90	830	5
53163201	32	90	855	5
53163401	34	80	965	5
53163501	35	80	981	5
53163601	36	90	880	5
53163801	38	89	1108	5
53163901	39	90	1078	5
53164101	41	90	1084	5
53164601	46	90	1264	5
53165001	50	90	1484	1
53165501	55	90	1350	1
53166001	60	90	1864	1
53166501	65	90	2098	1
53167001	70	90	2440	1



5363



INNENSECHSKANT-KRAFT-EINSATZ
HEXAGON IMPACT SOCKET

DIN 3121
Chrom-Molybdän-Stahl
schwarz

DIN 3121
Chrome-Molybdenum steel
black

Art.-No.	mm	l-mm-l	g	
53631401	14	100	592	5
53631701	17	100	761	5
53631901	19	100	628	5
53632201	22	100	820	5
53632401	24	100	675	5
53632701	27	100	753	5



5311

KRAFT-VERLÄNGERUNG
IMPACT EXTENSION BAR

25 1"  

DIN 3121
Chrom-Molybdän Stahl
schwarz

DIN 3121
Chrome-Molybdenum steel
black

Art.-No.	l-mm-l		
9245651	175	1475	1
9243211	330	2480	1

5312

KRAFT-KARDAN-GELENK
IMPACT UNIVERSAL JOINT

25 1"  

DIN 3121
Chrom-Molybdän Stahl
schwarz

DIN 3121
Chrome-Molybdenum steel
black

Art.-No.	l-mm-l		
9266520	133	1316	1



5314

KRAFT-ÜBERGANGSTEIL
IMPACT ADAPTOR

25 1" 

20 3/4" 

DIN 3121
1" innen, 3/4" außen
Chrom-Molybdän Stahl
schwarz

DIN 3121
1" female, 3/4" male
Chrome-Molybdenum steel
black

Art.-No.	l-mm-l		
9240041	70	344	5

5315

KRAFT-ÜBERGANGSTEIL
IMPACT ADAPTOR

25 1" 

38 1 1/2" 

DIN 3121
1" innen, 1 1/2" außen
Chrom-Molybdän Stahl
schwarz

DIN 3121
1" female, 1 1/2" male
Chrome-Molybdenum steel
black

Art.-No.	l-mm-l		
9278770	90	1057	1





5317

STIFT FÜR KRAFT-EINSÄTZE UND VERBINDUNGSTEILE
LOCKING PIN FOR IMPACT SOCKETS AND CONNECTING PARTS

25 1" 

Chrom-Molybdän Stahl
schwarz

Chrome-Molybdenum steel
black

Art.-No.	 mm	l-mm-l		
9245380	19-70	46	7	10
53177590	75-90	75	7	10



5318

RING FÜR KRAFT-EINSÄTZE UND VERBINDUNGSTEILE
LOCKING RING FOR IMPACT SOCKETS AND CONNECTING PARTS

25 1" 

schwarz

black

Art.-No.	 mm		
9245390	19-70	7	10
53187590	75-90	7	10





6310

38 1½" 

KRAFT-EINSATZ, 6-KANT, DIN 3129
IMPACT SOCKET, 6-POINT, DIN 3129

DIN 3121
Chrom-Molybdän Stahl
schwarz

DIN 3121
Chrome-Molybdenum steel
black

Art.-No.	 mm	mm-l		
63103601	36	80	2220	1
63104101	41	80	2370	1
63104601	46	85	2580	1
63105001	50	85	2500	1
63105501	55	90	2600	1
63106001	60	90	2732	1
63106501	65	95	2900	1
63107001	70	100	3700	1
63107501	75	105	4000	1
63108001	80	110	4480	1
63108501	85	120	5500	1
63109001	90	120	5660	1
63109501	95	120	6800	1
63110001	100	125	7850	1
63110501	105	125	8100	1
63111001	110	125	8300	1
63112001	120	135	10300	1





**DREHMOMENT-
WERKZEUGE**
TORQUE TOOLS

05



2374

AUTOMATISCHER DREHMOMENTSCHLÜSSEL AUTOMATIC TORQUE WRENCH

6,3 1/4" 

DIN 3120 A

Chrom-Vanadium Stahl | verchromt

2-Komponentenheft

kompakte Bauform

selbstauslösend

Rechts- und Linksanzug

Genauigkeit +/- 3% vom Skalenwert bei Rechtsanzug

feine Skaleneinteilung

Umschaltknarre, 45 Zähne

Seriennummer und Zertifikat

Doppelskala Nm / lbf.ft

DIN 3120 A

Chrome-Vanadium steel | chrome plated

two component handle

compact design

self-releasing

clock- and counter-clockwise operation



accuracy +/- 3% from scale value by clockwise tightening

fine scale graduation

Reversible Ratchet, 45 teeth

serial number and certificate

double-scale Nm / lbf.ft

Art.-No.		Meßbereich Range Nm	Meßbereich Range lbs/ft	Teilung Scale split Nm	Feinskala Vernier scale Nm	l-mm-l		
9292710	1/4"	2,5-12,0	1,7-8,7	0,5	0,025	285	700	1
9292720	1/4"	4,0-20,0	2,5-15,0	1,0	0,05	285	700	1

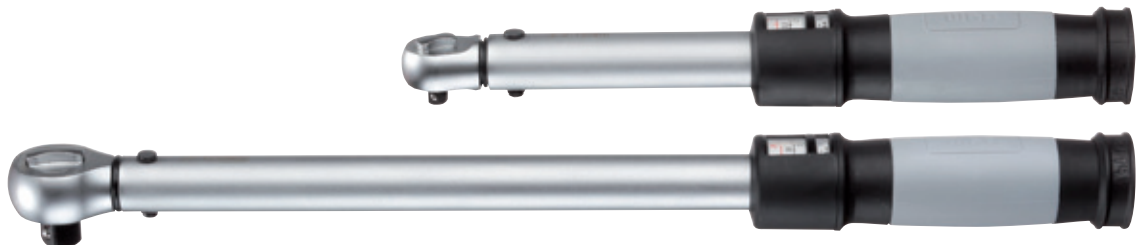

2371

AUTOMATISCHER DREHMOMENTSCHLÜSSEL AUTOMATIC TORQUE WRENCH

10 3/8" 

DIN 3120 A

Chrom-Vanadium Stahl | verchromt

2-Komponentenheft

kompakte Bauform

selbstauslösend

Rechts- und Linksanzug

Genauigkeit +/- 3% vom Skalenwert bei Rechtsanzug

feine Skaleneinteilung

Umschaltknarre, 45 Zähne

Seriennummer und Zertifikat

Doppelskala Nm / lbf.ft

DIN 3120 A

Chrome-Vanadium steel | chrome plated

two component handle

compact design

self-releasing

clock- and counter-clockwise operation



accuracy +/- 3% from scale value by clockwise tightening

fine scale graduation

Reversible Ratchet, 45 teeth

serial number and certificate

double-scale Nm / lbf.ft

Art.-No.		Meßbereich Range Nm	Meßbereich Range lbs/ft	Teilung Scale split Nm	Feinskala Vernier scale Nm	l-mm-l		
9299303	3/8"	6-30	4-20	0,15	0,15	315	836	1
9301763	3/8"	10-60	9-45	5,0	0,25	385	1012	1



2373

AUTOMATISCHER DREHMOMENTSCHLÜSSEL AUTOMATIC TORQUE WRENCH

DIN 3120 A

Chrom-Vanadium Stahl | verchromt

2-Komponentenheft

selbstausslösend

Rechts- und Linksanzug

Genauigkeit +/- 3% vom Skalenwert bei Rechtsanzug

feine Skaleneinteilung

Umschaltknarre, 45 Zähne

Seriennummer und Zertifikat

Doppelskala Nm / lbf.ft

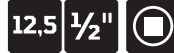

DIN 3120 A

Chrome-Vanadium steel | chrome plated

two component handle

self-releasing

clock- and counter-clockwise operation

accuracy +/- 3% from scale value by clockwise tightening

fine scale graduation

Reversible Ratchet, 45 teeth

serial number and certificate

double-scale Nm / lbf.ft

Art.-No.		Meßbereich Range Nm	Meßbereich Range lbs/ft	Teilung Scale split Nm	Feinskala Vernier scale Nm	l-mm-l		
9299283	1/2"	10-60	9-45	5,0	0,25	383	840	1
9292730	1/2"	25-125	20-90	5,0	0,25	438	1100	1
9294150	1/2"	40-200	30-147	10,0	0,50	438	1100	1
9299273	1/2"	65-335	50-250	15,0	0,75	438	1100	1



2389

AUTOMATISCHER DREHMOMENTSCHLÜSSEL FÜR EINSTECKWERKZEUGE AUTOMATIC TORQUE WRENCH FOR INSERT TOOLS

DIN 3120 A

Chrom-Vanadium Stahl | verchromt

2-Komponentenheft

selbstausslösend

Rechts- und Linksanzug

Doppelskala Nm / lbf.ft

4-kant-Aufnahme für Einsteckwerkzeuge

Seriennummer und Zertifikat

Sichere Verriegelung des Einstellknopfes

Genauigkeit +/- 3% vom Skalenwert bei Rechtsanzug



DIN 3120 A

Chrome-Vanadium steel | chrome plated

two component handle

self-releasing

clock- and counter-clockwise operation

double-scale Nm / lbf.ft

with female square for insert tools

serial number and certificate

safe lock function of adjustment knob

accuracy +/- 3% from scale value by clockwise tightening

Art.-No.	Aufnahme	Meßbereich Range Nm	Meßbereich Range lbs/ft	Teilung Scale split Nm	Feinskala Vernier scale Nm	l-mm-l		
23890600	9 x 12 mm	10-60	9-45	2,5	0,25	365	872	1
23892000	14 x 18 mm	40-200	30-150	10	1,0	455	965	1



2395

AUTOMATISCHER DREHMOMENTSCHLÜSSEL AUTOMATIC TORQUE WRENCH

DIN 3120 A

Chrom-Vanadium Stahl | verchromt

2-Komponentenheft

selbstauslösend

robuste Stahlausführung für hohe Drehmomente

Rechts- und Linksanzug

Doppelskala Nm / lbf.ft

Umschaltknarre, 36 Zähne

Seriennummer und Zertifikat

Sichere Verriegelung des Einstellknopfes

Genauigkeit +/- 4% vom Skalenwert bei Rechtsanzug

20 3/4"

DIN 3120 A

Chrome-Vanadium steel | chrome plated

two component handle

self-releasing

robust steel construction for high torques

clock- and counter-clockwise operation

double-scale Nm / lbf.ft

Reversible Ratchet, 36 teeth

serial number and certificate

safe lock function of adjustment knob

accuracy +/- 4% from scale value by clockwise tightening

Art.-No.	Aufnahme	Meßbereich Range Nm	Meßbereich Range lbs/ft	Teilung Scale split Nm	l-mm-l		
2395800	3/4"	150-800	129-609	50	1090	4890	1



2375

6,3 1/4" 10 3/8" 12,5 1/2"

UMSCHALTKNARREN-KOPF REVERSIBLE RATCHET HEAD

9x12

DIN 3120 A, ISO 1174-1

Chrom-Vanadium Stahl

verchromt

für Drehmomentschlüssel

Nr. 2389

DIN 3120 A, ISO 1174-1

Chrome-Vanadium steel

chrome plated

für Torque Wrenches

No. 2389

Art.-No.			l-mm-l		
9222240	1/4"	33	45	76	1
9222250	3/8"	33	52	155	1
9222260	1/2"	33	52	168	1

2376

12,5 1/2" 20 3/4"

UMSCHALTKNARREN-KOPF REVERSIBLE RATCHET HEAD

14x18

DIN 3120 A, ISO 1174-1

Chrom-Vanadium Stahl

verchromt

für Drehmomentschlüssel

Nr. 2389

DIN 3120 A, ISO 1174-1

Chrome-Vanadium steel

chrome plated

für Torque Wrenches

No. 2389

Art.-No.			l-mm-l		
9223990	1/2"	53	70	80	1
9224990	3/4"	53	80	660	1



2380

MAUL-EINSTECKWERKZEUG
OPEN ENDED INSERT TOOL

9x12

DIN ISO 961, DIN ISO 1711
Chrom-Vanadium Stahl | verchromt
für Drehmomentschlüssel Nr. 2389

DIN ISO 961, DIN ISO 1711
Chrome-Vanadium steel | chrome plated
for Torque Wrenches No. 2389

Art.-No.	Ø mm	l mm	g	Box
23800700	7	39	35	10
23800800	8	38	39	10
23800900	9	39	35	10
23801000	10	40	40	10
23801100	11	40	42	10
23801200	12	40	40	10
23801300	13	40	43	10
23801400	14	44	54	10
23801500	15	44	57	10
23801600	16	45	60	10
23801700	17	44	60	10
23801900	19	47	64	10

Für Zoll-Abmessungen sprechen Sie uns bitte an. | Please ask us for A/F inch patterns.



2381

MAUL-EINSTECKWERKZEUG
OPEN ENDED INSERT TOOL

14x18

DIN ISO 961, DIN ISO 1711
Chrom-Vanadium Stahl | verchromt
für Drehmomentschlüssel Nr. 2389

DIN ISO 961, DIN ISO 1711
Chrome-Vanadium steel | chrome plated
for Torque Wrenches No. 2389

Art.-No.	Ø mm	l mm	g	Box
23901300	13	58	116	10
23901400	14	59	119	10
23901500	15	59	120	10
23901600	16	59	115	10
23901700	17	60	134	10
23901800	18	61	136	10
23901900	19	61	134	10
23902200	22	62	164	10
23902400	24	65	181	10
23902700	27	70	225	10
23903000	30	70	236	10
23903200	32	72	246	10
23903600	36	74	291	10

Für Zoll-Abmessungen sprechen Sie uns bitte an. | Please ask us for A/F inch patterns.



2384

RING-EINSTECKWERKZEUG
RING INSERT TOOL

9x12

DIN ISO 961, DIN ISO 1711
Chrom-Vanadium Stahl | verchromt
für Drehmomentschlüssel Nr. 2389

DIN ISO 961, DIN ISO 1711
Chrome-Vanadium steel | chrome plated
for Torque Wrenches No. 2389

Art.-No.	Ø mm	l mm	g	Box
23000700	7	41	40	10
23000800	8	41	40	10
23001000	10	43	40	10
23001100	11	44	40	10
23001200	12	47	50	10
23001300	13	47	50	10
23001400	14	47	50	10
23001500	15	46	60	10
23001600	16	47	60	10
23001700	17	48	60	10
23001800	18	50	60	10
23001900	19	50	60	10
23002200	22	52	60	10

Für Zoll-Abmessungen sprechen Sie uns bitte an. | Please ask us for A/F inch patterns.



2385

RING-EINSTECKWERKZEUG
RING INSERT TOOL

14x18

DIN ISO 961, DIN ISO 1711
Chrom-Vanadium Stahl | verchromt
für Drehmomentschlüssel Nr. 2389

DIN ISO 961, DIN ISO 1711
Chrome-Vanadium steel | chrome plated
for Torque Wrenches No. 2389

Art.-No.	Ø mm	l mm	g	Box
23101300	13	62	126	10
23101700	17	64	135	10
23101900	19	66	143	10
23102200	22	69	155	10
23102400	24	69	149	10
23102700	27	78	205	10
23103000	30	79	199	10
23103200	32	80	204	10
23103400	34	83	225	10
23103600	36	83	218	10

Für Zoll-Abmessungen sprechen Sie uns bitte an. | Please ask us for A/F inch patterns.



KRAFTVERVIELFÄLTIGUNGS- SCHLÜSSEL

Kraftvervielfältigungsschlüssel mit Planetengetriebe dient zur Ausübung großer Drehmomente, die mit einem normalen Schraubenschlüssel nicht erzielt werden können. Durch seine mehrfache Untersetzung ist der X-4 Kraftvervielfältigungsschlüssel ein ideales Schraubwerkzeug. Mit geringem Kraftaufwand wird auf engem Raum ein hohes Drehmoment erreicht.

X-4 BEANSPRUCHT WENIG RAUM

Sofern bei besonders engen Raumverhältnissen der Einsatz der zusammengesteckten Geräte wegen ihrer Gesamtbauhöhe nicht möglich ist, kann eine Ringverlängerung aufgesteckt werden. Ringverlängerungen auf Wunsch offen, z. B. bei Hochdruckflanschen usw.

MULTIPLIER WRENCH

Multiplier Wrench with planetary gear serves for producing high torques that cannot be attained with normal wrenches. Due to its multiple reduction the X-4 Multiplier Wrench is an ideal fastening tool. If you have only limited space, a high torque can be achieved with little force.

X-4 NEEDS ONLY LITTLE SPACE

If there is very little space and the assembled tool cannot be used due to its total height a special extension can be fitted. On request open extensions are available, e. g. for high-pressure flanges, etc.

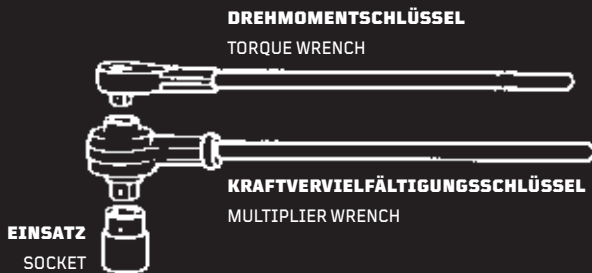



2388

X-4 DREHMOMENTVERVIELFÄLTIGUNGSSCHLÜSSEL X-4 MULTIPLIER WRENCH



Chrom-Vanadium Stahl
verchromt
Kopf verzahnt
mit geringer Untersetzung

Chrome-Vanadium steel
chrome plated
geared head wrenches
with low ratio

Art.-No.			Zulässige Belastung Permissible For load (Nm)	Für For M14-M39	Schaft-Ø Shank Ø (mm)	Getriebe- kopf-Ø Gearhead Ø (mm)	Getriebe- kopf-Höhe Height of gearhead (mm)	Getriebe- kopf-Länge Length of gearhead (mm)	Austritts- höhe Height of square drive (mm)	Eintrittshöhe Height of square drive hole (mm)	l-mm-l		
23880000	1/2"	3/4"	1356	M14-M39	29	89	45	178	26	13	585	3200	1
23880100	3/4"	3/4"	1356	M14-M39	29	89	45	178	26	22	585	3200	1
23880200	3/4"	1"	2712	M24-M52	25	95	57	170	32	24	665	6400	1
23880300*	3/4"	1"	2712	M24-M52	25	95	57	170	32	38	665	6900	1
23880400	3/4"	1.1/2"	4067	M24-M52	35	132	59	246	38	25	762	14000	1
23880500	1"	1.1/2"	4067	M27-M110	35	134	77	250	51	25	760	14000	1
23880600	1"	1.1/2"	10847	M27-M110	70	165	121	307	31	25	787	21000	1
23880700	1"	2.1/2"	16270	M48-M140	50	216	93	292	71	25	780	33000	1

*23880300 mit Rücklaufsperr | *23880300 with anti backlash device





SCHRAUBENDREHER
SCREWDRIVERS

06







520



WERKSTATT-SCHRAUBENDREHER, DIN ISO 2380
ENGINEERS SCREWDRIVER, DIN ISO 2380

für Schlitzschrauben
Chrom-Vanadium Stahl
vernickelt
Hartholzheft mit Lederkappe
durchgehende Klinge mit
Sechskantansatz

for slotted screws
Chrome-Vanadium steel
nickel plated
hardwood handle with leather cap
protruding blade with
hexagon bolster

Art.-No.	 mm	 mm	 mm	l-mm-l	 g	
5203576	3,5	75	1,2	170	50	10
5204596	4,5	90	0,8	185	54	10
5205516	5,5	100	1,0	200	65	10
5207126	7,0	125	1,2	235	107	10
5209156	9,0	150	1,6	270	153	10
5210176	10,0	175	1,6	295	190	10
5212206	12,0	200	2,0	330	293	5
5214256	14,0	250	2,5	380	326	5





525



PH SCHRAUBENDREHER, DIN ISO 8764
PH SCREWDRIVER, DIN ISO 8764

für PH-Kreuzschlitzschrauben
Chrom-Vanadium Stahl
vernickelt
Hartholzheft mit Lederkappe
durchgehende Klinge mit
Sechskantansatz

for PH screws
Chrome-Vanadium steel
nickel plated
hardwood handle with leather cap
protruding blade with
hexagon bolster

Art.-No.		 mm	l-mm-l	 g	
9203736	PH1	80	175	58	10
9204116	PH2	100	220	83	10
9204776	PH3	150	270	166	10
9207756	PH4	200	330	262	5





526



PZ SCHRAUBENDREHER, DIN ISO 8764
PZ SCREWDRIVER, DIN ISO 8764

für PZ-Kreuzschlitzschrauben
Chrom-Vanadium Stahl
vernickelt
Hartholzheft mit Lederkappe
durchgehende Klinge mit
Sechskantansatz

for PZ screws
Chrome-Vanadium steel
nickel plated
hardwood handle with leather cap
protruding blade with
hexagon bolster

Art.-No.		 mm	l-mm-l	 g	
5260006	PZ1	80	175	58	10
5260016	PZ2	100	200	82	10
5260026	PZ3	150	270	165	10
5260036	PZ4	200	330	293	5





522 S



**SCHRAUBENDREHER-GARNITUR,
DIN ISO 2380, DIN ISO 8764**
SCREWDRIVER SET, DIN ISO 2380, DIN ISO 8764

Chrom-Vanadium Stahl
vernickelt
Hartholzheft mit Lederkappe
durchgehende Klinge mit
Sechskantansatz
5-tlg.
im Sichtkarton

Chrome-Vanadium steel
nickel plated
hardwood handle with leather cap
protruding blade with
hexagon bolster
5 pcs.
in display cardboard box

Inhalt Content	Klinge Blade	mm	mm
520	⊖	4,5	90
520	⊖	5,5	100
520	⊖	7,0	125
525	⊕	PH1	80
525	⊕	PH2	100

Art.-No.	g	1
5220006	438	1

521 S



**SCHRAUBENDREHER-GARNITUR,
DIN ISO 2380, DIN ISO 8764**
SCREWDRIVER SET, DIN ISO 2380, DIN ISO 8764

Chrom-Vanadium Stahl
vernickelt
Hartholzheft mit Lederkappe
durchgehende Klinge mit
Sechskantansatz
7-tlg.
im Sichtkarton

Chrome-Vanadium steel
nickel plated
hardwood handle with leather cap
protruding blade with
hexagon bolster
7 pcs.
in display cardboard box

Inhalt Content	Klinge Blade	mm	mm
520	⊖	3,5	75
520	⊖	4,5	90
520	⊖	5,5	100
520	⊖	7,0	125
520	⊖	9,0	150
525	⊕	PH1	80
525	⊕	PH2	100

Art.-No.	g	1
9216756	683	1

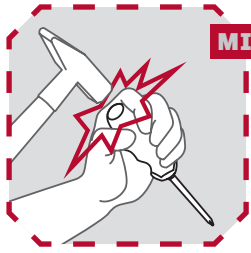

MIT SCHLAGKAPPE!
WITH HAMMER CAP

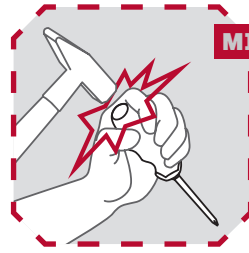

MIT SCHLAGKAPPE!
WITH HAMMER CAP



573





WERKSTATT-SCHRAUBENDREHER, DIN ISO 2380
ENGINEERS SCREWDRIVER, DIN ISO 2380

für Schlitzschrauben
S2-Profi-Stahl
verchromt
2-Komponentenheft
durchgehende Klinge
mit Sechskantansatz
mit Schlagkappe

for slotted screws
S2 Professional steel
chrome plated
two component handle
protruding blade
with hexagon bolster
with hammer cap

* ohne Sechskantansatz

*without hexagon bolster

Art.-No.	 mm	 mm	 mm	l-mm-l	 g	
5730313*	3,0	75	0,6	160	36	10
5730413	4,0	100	1,0	185	43	10
5730513	5,0	75	1,2	175	82	10
5730503	5,0	150	1,0	250	94	10
5730553	5,5	125	1,0	225	89	10
5730613*	6,0	38	1,2	100	62	10
5730603	6,0	150	1,2	260	128	10
5730803	8,0	150	1,6	265	186	10



574





PH SCHRAUBENDREHER, DIN ISO 8764
PH SCREWDRIVER, DIN ISO 8764

für PH-Kreuzschlitzschrauben
S2-Profi-Stahl
verchromt
2-Komponentenheft
durchgehende Klinge
mit Sechskantansatz
mit Schlagkappe

for PH screws
S2 Professional steel
chrome plated
two component handle
protruding blade
with hexagon bolster
with hammer cap

* ohne Sechskantansatz

*without hexagon bolster

Art.-No.		 mm	l-mm-l	 g	
5740013*	PH0	75	160	36	10
5740113	PH1	75	175	82	10
5740123	PH1	100	202	86	10
5740103	PH1	150	250	96	10
5740213*	PH2	38	100	62	10
5740203	PH2	150	260	128	10
5740303	PH3	150	270	190	10



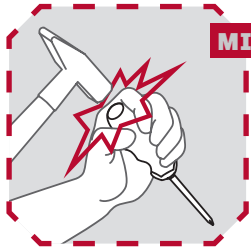

MIT SCHLAGKAPPE!
WITH HAMMER CAP

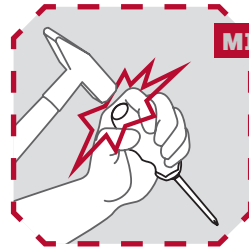

MIT SCHLAGKAPPE!
WITH HAMMER CAP



571 S



SCHRAUBENDREHER-SET, DIN ISO 2380, DIN ISO 8764
SCREWDRIVER SET, DIN ISO 2380, DIN ISO 8764

S2-Profi-Stahl
verchromt
2-Komponentenheft
durchgehende Klinge
mit Sechskantansatz
mit Schlagkappe
12-tlg.
im Sichtkarton

S2 Professional steel
chrome plated
two component handle
protruding blade
with hexagon bolster
with hammer cap
12 pcs.
in display cardboard box

* ohne Sechskantansatz

*without hexagon bolster

Inhalt Content	Klinge Blade	mm	mm
573*	⊖	6,0	38
573*	⊖	3,0	75
573	⊖	5,0	75
573	⊖	5,0	150
573	⊖	6,0	150
573	⊖	8,0	150
574*	⊕	PH2	38
574*	⊕	PH0	75
574	⊕	PH1	75
574	⊕	PH1	150
574	⊕	PH2	150
574	⊕	PH3	150

Art.-No.	H x B x T (mm) H x W x L (mm)	g	box
5710003	295 x 255 x 40	1420	1

577 S



SCHRAUBENDREHER-SET, DIN ISO 2380, DIN ISO 8764
SCREWDRIVER SET, DIN ISO 2380, DIN ISO 8764

S2-Profi-Stahl
verchromt
2-Komponentenheft
durchgehende Klinge
mit Sechskantansatz
mit Schlagkappe
6-tlg.
im Sichtkarton

S2 Professional steel
chrome plated
two component handle
protruding blade
with hexagon bolster
with hammer cap
6 pcs.
in display cardboard box

* ohne Sechskantansatz

*without hexagon bolster

Inhalt Content	Klinge Blade	mm	mm
573*	⊖	3,0	75
573	⊖	4,0	100
573	⊖	5,5	125
573	⊖	6,0	150
574	⊕	PH1	100
574	⊕	PH2	150

Art.-No.	H x B x T (mm) H x W x L (mm)	g	box
5770063	280 x 135 x 40	613	1

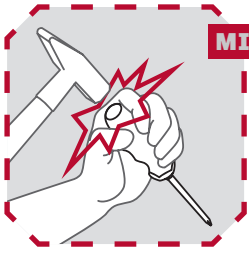

MIT SCHLAGKAPPE!
WITH HAMMER CAP



571 TD

**THEKENDISPLAY SCHRAUBENDREHER-GARNITUREN,
DIN ISO 2380, DIN ISO 8764**
DISPLAY SCREWDRIVER SETS, DIN ISO 2380, DIN ISO 8764

S2-Profi-Stahl
verchromt
2-Komponentenheft
durchgehende Klinge
mit Sechskantansatz
mit Schlagkappe

6 Schraubendreher-Sets, 12-tlg.



S2 Professional steel
chrome plated
two component handle
protuding blade
with hexagon bolster
with hammer cap

6 Screwdriver Sets, 12 pcs.

Art.-No.

H x B x T (mm)
H x W x L (mm)



5710120

305 x 280 x 315

8869

1

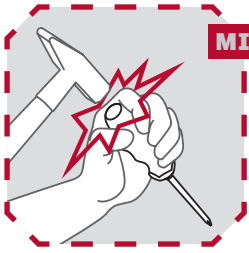

MIT SCHLAGKAPPE!
WITH HAMMER CAP



577 TD

**THEKENDISPLAY SCHRAUBENDREHER-GARNITUREN,
DIN ISO 2380, DIN ISO 8764**
DISPLAY SCREWDRIVER SETS, DIN ISO 2380, DIN ISO 8764

S2-Profi-Stahl
verchromt
2-Komponentenheft
durchgehende Klinge
mit Sechskantansatz
mit Schlagkappe

6 Schraubendreher-Sets, 6-tlg.



S2 Professional steel
chrome plated
two component handle
protuding blade
with hexagon bolster
with hammer cap

6 Screwdriver Sets, 6 pcs.

Art.-No.	H x B x T (mm) H x W x L (mm)		
5770060	305 x 185 x 315	3708	1



MIT SCHLAGKAPPE!
WITH HAMMER CAP

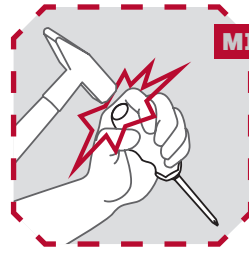

MIT SCHLAGKAPPE!
WITH HAMMER CAP



576

PZ SCHRAUBENDREHER, DIN ISO 8764
PZ SCREWDRIVER, DIN ISO 8764

für PZ-Kreuzschlitzschrauben
S2-Profi-Stahl
verchromt
2-Komponentenheft
durchgehende Klinge
mit Sechskantansatz
mit Schlagkappe

for PZ screws
S2 Professional steel
chrome plated
two component handle
protruding blade
with hexagon bolster
with hammer cap

* ohne Sechskantansatz

*without hexagon bolster

Art.-No.					
5760013*	P20	75	160	70	10
5760023	P21	100	200	85	10
5760033	P22	125	235	95	10
5760043	P23	150	270	130	10



576 S

PZ SCHRAUBENDREHER-SET, DIN ISO 8764
PZ SCREWDRIVER SET, DIN ISO 8764

S2-Profi-Stahl
verchromt
2-Komponentenheft
durchgehende Klinge
mit Sechskantansatz
mit Schlagkappe
4-tlg.
im Sichtkarton

S2 Professional steel
chrome plated
two component handle
protruding blade
with hexagon bolster
with hammer cap
4 pcs.
in display cardboard box

* ohne Sechskantansatz

*without hexagon bolster

Inhalt Content	Klinge Blade		
576*		P20	75
576		P21	100
576		P22	125
576		P23	150

Art.-No.	H x B x T [mm] H x W x L [mm]		
5760003	300 x 165 x 40	580	1



MIT SCHLAGKAPPE!
WITH HAMMER CAP



576 TD

THEKENDISPLAY
PZ SCHRAUBENDREHER-GARNITUREN, DIN ISO 8764
DISPLAY
PZ SCREWDRIVER SETS, DIN ISO 8764



S2-Profi-Stahl
verchromt
2-Komponentenheft
durchgehende Klinge
mit Sechskantansatz
mit Schlagkappe

S2 Professional steel
chrome plated
two component handle
protuding blade
with hexagon bolster
with hammer cap

6 Schraubendreher-Sets, 4-tlg.

6 Screwdriver Sets, 4 pcs.

Art.-No.	H x B x T (mm) H x W x L (mm)		
5760060	305 x 185 x 315	3708	1



591



VDE WERKSTATT-SCHRAUBENDREHER, DIN ISO 2380
VDE ENGINEERS SCREWDRIVER, DIN ISO 2380

für Schlitzschrauben
isoliert nach DIN EN 60900
(VDE 0682/201)
S2-Profi-Stahl
2-Komponentenheft
Klinge mit magnetischer Spitze

for slotted screws
insulated according to DIN EN
60900
(VDE 0682/201)
S2 Professional steel
S2 Professional steel
two component handle
blade with magnetic tip

Art.-No.	mm	mm	mm	l-mm-l	g	
5910000	2,5	75	1,2	160	30	10
5910010	4,0	100	1,2	180	40	10
5910020	5,5	125	1,2	225	70	10
5910030	6,5	150	1,0	260	110	10

593



VDE PH SCHRAUBENDREHER, DIN ISO 8764
VDE PH SCREWDRIVER, DIN ISO 8764

für PH-Kreuzschlitzschrauben
isoliert nach DIN EN 60900
(VDE 0682/201)
S2-Profi-Stahl
2-Komponentenheft
Klinge mit magnetischer Spitze

for PH screws
insulated according to DIN EN
60900
(VDE 0682/201)
S2 Professional steel
two component handle
blade with magnetic tip

Art.-No.		mm	l-mm-l	g	
5930000	PH0	60	140	30	10
5930010	PH1	80	180	60	10
5930020	PH2	100	210	90	10
5930030	PH3	150	270	150	10

594 S



**VDE SCHRAUBENDREHER-SET,
DIN ISO 2380, DIN ISO 8764**
VDE SCREWDRIVER SET
DIN ISO 2380, DIN ISO 8764

isoliert nach DIN EN 60900
(VDE 0682/201)
S2-Profi-Stahl
2-Komponentenheft
Klinge mit magnetischer Spitze
9-tig.
im Sichtkarton

insulated according to DIN EN
60900
(VDE 0682/201)
S2 Professional steel
two component handle
blade with magnetic tip
9 pcs.
in display cardboard box

Inhalt Content	Klinge Blade	mm	mm
591		2,5	75
591		4,0	100
591		6,5	150
593		PH0	60
593		PH1	80
593		PH2	100
593		PH3	150
Spannungsprüfer Voltage tester		3,0	65

Art.-No.	H x B x T (mm) H x W x L (mm)	g	
5940000	305 x 195 x 40	777	1





556 TD

THEKENDISPLAY SCHRAUBENDREHER-GARNITUREN, DIN ISO 2380, DIN ISO 8764
DISPLAY SCREWDRIVER SETS, DIN ISO 2380, DIN ISO 8764

12-tlg.:
6 Schraubendreher-Garnituren, 12-tlg.
6 VDE Schraubendreher-Garnituren, 9-tlg.



12 pcs.:
6 Screwdriver Sets, 12 pcs.
6 VDE Screwdriver Sets, 9 pcs.

Art.-No.	H x B x T (mm) H x W x L (mm)		
5560003	320 x 500 x 370	13500	1



798

TAMPER TORX®-SCHRAUBENDREHER TAMPER TORX® SCREWDRIVER

für Innen-TORX®-Schrauben mit
Sicherheitsstift
Chrom-Molybdän Stahl
verchromt
2-Komponentenheft
mit Aufhängeloch

for inside TORX®-screws with
safety pin
Chrome-Molybdenum steel
chrome plated
two component handle
with hanging hole







790





TX SCHRAUBENDREHER TX SCREWDRIVER

für Innen-TORX®-Schrauben
Chrom-Molybdän Stahl
verchromt
2-Komponentenheft
mit Aufhängeloch

for inside TORX®-screws
Chrome-Molybdenum steel
chrome plated
two component handle
with hanging hole



Art.-No.		 (mm)	(mm)		
7980003	TX8	70	155	30	10
7980013	TX9	70	155	30	10
7980023	TX10	80	175	39	10
7980033	TX15	80	175	42	10
7980043	TX20	90	185	47	10
7980053	TX25	90	185	83	10
7980073	TX30	110	215	80	10
7980083	TX40	120	240	115	10
7980093	TX45	120	240	135	10

Art.-No.		 (mm)	(mm)		
7900003	TX5	70	155	29	10
7900013	TX6	70	155	30	10
7900023	TX7	70	155	30	10
7900033	TX8	70	155	30	10
7900043	TX9	70	155	30	10
7900053	TX10	80	175	32	10
7900063	TX15	80	175	42	10
7900073	TX20	90	185	46	10
7900083	TX25	90	185	50	10
7900093	TX27	110	215	74	10
7900103	TX30	110	215	79	10
7900113	TX40	120	240	138	10
7900123	TX45	120	240	138	10
7900143	TX55	120	240	210	5
7900153	TX60	130	240	278	5

TORX® - eingetragenes Warenzeichen der Firma Ruia Global Fasteners AG, Germany.
TORX® is a registered Trademark of Ruia Global Fasteners AG, Germany.

790 S

TX SCHRAUBENDREHER-SET TX SCREWDRIVER SET

für Innen-TORX®-Schrauben
Chrom-Molybdän Stahl
 verchromt
 2-Komponentenheft
 mit Aufhängeloch
 7-tlg.
 im Sichtkarton

for inside TORX®-screws
 Chrome-Molybdenum steel
 chrome plated
 two component handle
 with hanging hole
 7 pcs.
 in display cardboard box



Inhalt Content	Klinge Blade	mm	mm
790		TX10	80
790		TX15	80
790		TX20	90
790		TX25	90
790		TX27	110
790		TX30	110
790		TX40	120

Art.-No.	H x B x T (mm) H x W x L (mm)	g	
7900903	340 x 200 x 30	540	1







535

VERGASER-WERKSTATT-SCHRAUBENDREHER, DIN ISO 2380
STUBBY ENGINEERS SCREWDRIVER,
DIN ISO 2380

für Schlitzschrauben
Chrom-Vanadium Stahl
verchromt mit schwarzer Spitze
Heft mit Aufhängeloch

for slotted screws
Chrome-Vanadium steel
chrome plated with black tip
handle with hanging hole

Art.-No.	 mm	 mm	 mm	l-mm-l	 g	
5350003	4,0	25	0,8	75	30	10
5350013	5,5	25	0,8	75	34	10
5350023	6,0	25	1,0	75	39	10
5350033	6,5	25	1,2	75	39	10







538

PH VERGASER-SCHRAUBENDREHER, DIN ISO 8764
PH STUBBY SCREWDRIVER,
DIN ISO 8764

für PH-Kreuzschlitzschrauben
Molybdän-Vanadium Stahl
verchromt mit schwarzer Spitze
Heft mit Aufhängeloch

for PH screws
Molybdenum-Vanadium steel
chrome plated with black tip
handle with hanging hole

Art.-No.		 mm	l-mm-l	 g	
5380003	PH1	25	75	34	10
5380013	PH2	25	75	39	10
5380023	PH3	25	75	50	10







541

PZ VERGASER-SCHRAUBENDREHER, DIN ISO 8764
PZ STUBBY SCREWDRIVER, DIN ISO 8764

für PZ-Kreuzschlitzschrauben
Molybdän-Vanadium Stahl
verchromt mit schwarzer Spitze
Heft mit Aufhängeloch

for PZ screws
Molybdenum-Vanadium steel
chrome plated with black tip
handle with hanging hole

Art.-No.		 mm	l-mm-l	 g	
5410003	PZ1	25	75	34	10
5410013	PZ2	25	75	39	10
5410023	PZ3	25	75	50	10







555

VDE SPANNUNGSPRÜFER
VDE VOLTAGE TESTER

für Schlitzschrauben
Chrom-Vanadium Stahl
verchromt
für 120-250 Volt

for slotted screws
Chrome-Vanadium steel
chrome plated
for 120-250 Volt

Art.-No.	 mm	 mm	l-mm-l	 g	
9287826	3	65	140	15	1
55501403	3	65	140	20	10





480

**SECHSKANT-STECKSCHLÜSSEL MIT GRIFF,
DIN 3125**
HEXAGON NUT DRIVER WITH HANDLE,
DIN 3125

**Chrom-Vanadium Stahl
vernickelt**
**2-Komponentenheft
mit Aufhängeloch**

Chrome-Vanadium steel
nickel plated
two component handle
with hanging hole

Art.-No.	mm	mm	l-mm-l	g	
4800003	3	125	220	69	10
4800013	3,5	125	220	75	10
4800023	4	125	220	70	10
4800033	4,5	125	220	72	10
4800043	5	125	220	72	10
4800053	5,5	125	230	74	10
4800063	6	125	230	74	10
4800073	7	125	230	101	10
4800083	8	125	230	102	10
4800093	9	125	230	106	10
4800103	10	125	230	108	10
4800113	11	125	245	107	5
4800123	12	125	245	153	5
4800133	13	125	245	153	5
4800143	14	125	245	160	5
4800153	15	125	245	160	5
4800163	17	125	245	178	5
4800173	19	125	245	210	5



542

**SCHRAUBENDREHER MIT MAGNETBITHALTER,
ÄHNLICH DIN 3125**
SCREWDRIVER WITH MAGNETIC BIT HOLDER,
SIMILAR TO DIN 3125

**Chrom-Vanadium Stahl
vernickelt**
**2-Komponentenheft mit
Aufhängeloch**

Chrome-Vanadium steel
nickel plated
two component handle with
hanging hole

Art.-No.	AF"	mm	l-mm-l	g	
9271040	1/4"	125	235	118	10





481

SECHSKANT-STECKSCHLÜSSEL MIT QUERGRIF, DIN 3125
HEXAGON NUT DRIVER WITH T-HANDLE, DIN 3125

**Chrom-Vanadium Stahl
vernickelt**
**Kunststoffquergriff
mit Aufhängeloch**

Chrome-Vanadium steel
nickel plated
plastic T-handle
with hanging hole

Art.-No.	mm	mm	mm mm	g	
9295476	5,5	230	38 x 90	116	5
9216816	6	125	38 x 90	67	10
9216826	7	125	38 x 90	82	10
9295486	7	230	38 x 91	115	5
9216836	8	125	38 x 90	84	10
9216846	8	230	38 x 90	116	5
9216856	8	350	38 x 90	223	5
9216866	9	125	38 x 90	85	10
9216876	10	125	38 x 90	107	10
9216886	10	230	38 x 90	147	5
9216896	10	350	38 x 90	195	5
9216906	11	125	38 x 90	107	10
9216916	12	125	46 x 110	132	10
9299726	12	230	46 x 110	173	5
9216926	13	125	46 x 110	163	5
9216936	13	230	46 x 110	178	5
9216946	13	350	46 x 110	223	5
9216956	14	125	46 x 110	142	5
9216966	17	125	46 x 110	142	5
9295496	17	230	46 x 110	116	5

481 MS

SECHSKANT-STECKSCHLÜSSEL-SATZ MIT QUERGRIF, DIN 3125
HEXAGON NUT DRIVER SET WITH T-HANDLE, DIN 3125

Chrom-Vanadium Stahl | vernickelt
**Kunststoffquergriff mit Aufhängeloch
im Metallhalter**

Chrome-Vanadium steel | nickel plated
plastic T-handle with hanging hole
in metal holder

Art.-No.	No.	mm	g	
9011070	481MS/6	5,5 7 8 10 13 17	1424	1



547

KRAFT-SCHRAUBENDREHER-BIT-SATZ IMPACT SCREWDRIVER BIT SET

S2-Profi-Stahl | schwarz | in schlagfester Kunststoffbox | 23-tlg.

Magnet-Halter 54 mm mit C-Clip

Bit für PH-Schrauben 2 x PH1 | 2 x PH2 | 1 x PH3 x 25 mm

Bit für PZ-Schrauben 2 x PZ1 | 2 x PZ2 | 1 x PZ3 x 25 mm

Bit für TORX®-Schrauben 1 x TX10 | 1 x TX15 | 2 x TX20 | 2 x TX25 | 1 x TX30 | 1 x TX40 x 25 mm

Bit für PH-Schrauben, lange Ausführung 1 x PH2 x 50 mm

Bit für PZ-Schrauben, lange Ausführung 1 x PZ2 x 50 mm

Bit für TORX®-Schrauben, lange Ausführung 1 x TX20 | 1 x TX25 x 50 mm



S2 Professional steel | black | in shatterproof plastic box | 23 pcs.

Magnetic Holder 54 mm with C-Clip

Bit for PH screws 2 x PH1 | 2 x PH2 | 1 x PH3 x 25 mm

Bit for PZ screws 2 x PZ1 | 2 x PZ2 | 1 x PZ3 x 25 mm

Bit for TORX® screws 1 x TX10 | 1 x TX15 | 2 x TX20 | 2 x TX25 | 1 x TX30 | 1 x TX40 x 25 mm

Bit for PH screws, long type 1 x PH2 x 50 mm

Bit for PZ screws, long type 1 x PZ2 x 50 mm

Bit for TORX® screws, long type 1 x TX20 | 1 x TX25 x 50 mm

Art.-No.	H x B x T (mm) H x W x L (mm)		
5470240	40 x 70 x 105	260	1



543

SCHRAUBENDREHER-BIT-SATZ SCREWDRIVER BIT SET

Chrom-Vanadium Stahl | verchromt, farbcodiert
in schlagfester Kunststoffbox | 32-tlg.

Schnellwechsel-Bit-Halter

Bit-Adapter

Bit für PH-Schrauben PH1 | PH2 | PH3

Bit für PZ-Schrauben PZ1 | PZ2 | PZ3

Bit für Schlitzschrauben 3 | 4 | 5 | 6 mm

Bit für Innensechskant-Schrauben 3 | 4 | 5 | 6 mm

Bit für TORX®-Schrauben TX10 | TX15 | TX20 | TX25 | TX27 | TX30 | TX40

Bit für TR-Schrauben TR10 | TR15 | TR20 | TR25 | TR27 | TR30 | TR40



Chrome-Vanadium steel | chrome plated, colour coded
in shatterproof plastic box | 32 pcs.

Quick-release Bit Holder

Bit Adaptor

Bit for PH screws PH1 | PH2 | PH3

Bit for PZ screws PZ1 | PZ2 | PZ3

Bit for slotted screws 3 | 4 | 5 | 6 mm

Bit for inside hexagon screws 3 | 4 | 5 | 6 mm

Bit for TORX® screws TX10 | TX15 | TX20 | TX25 | TX27 | TX30 | TX40

Bit for TR screws TR10 | TR15 | TR20 | TR25 | TR27 | TR30 | TR40

Art.-No.	H x B x T (mm) H x W x L (mm)		
5430320	40 x 70 x 105	296	1



1352



PH BITBOX PH BITBOX

S2-Profi-Stahl
sandgestrahlt, korrosionsgeschützt

S2 Professional steel
sandblasted, corrosion protected

in Kunststoffbox
Aufhängung mit Euroloch

in plastic box
hanger with Euro holes

Art.-No.		L x B x H (mm) L x W x H (mm)		
579298070	5 x PH2	90 x 43 x 17	35	10

1353



PZ BITBOX PZ BITBOX

S2-Profi-Stahl
sandgestrahlt, korrosionsgeschützt

S2 Professional steel
sandblasted, corrosion protected

in Kunststoffbox
Aufhängung mit Euroloch

in plastic box
hanger with Euro holes

Art.-No.		L x B x H (mm) L x W x H (mm)		
579298080	5 x P22	90 x 43 x 17	37	10
579298090	5 x P23	90 x 43 x 17	40	10



1354



TX BITBOX TX BITBOX

S2-Profi-Stahl
sandgestrahlt, korrosionsgeschützt

S2 Professional steel
sandblasted, corrosion protected

in Kunststoffbox
Aufhängung mit Euroloch

in plastic box
hanger with Euro holes

Art.-No.		L x B x H (mm) L x W x H (mm)		
579298100	5 x TX15	90 x 43 x 17	34	10
579298110	5 x TX20	90 x 43 x 17	34	10
579298120	5 x TX25	90 x 43 x 17	40	10
579298130	5 x TX30	90 x 43 x 17	41	10
579298140	5 x TX40	90 x 43 x 17	46	10

532



SCHNELLWECHSEL-BIT-HALTER QUICK RELEASE BIT HOLDER

Chrom-Vanadium Stahl
verchromt

Chrom-Vanadium steel
chrome plated

Art.-No.	l-mm-l		
9302380	60	31	10



ZANGEN
PLIERS

07





846

KOMBINATIONSZANGE, DIN ISO 5746
COMBINATION PLIERS, DIN ISO 5746

Chrom-Molybdän Stahl
verchromt, matt poliert
2-Komponentengriffe

Chrome-Molybdenum steel
chrome plated, matt polished
two component handle

Art.-No.	l-mm-l		
9269473	160	224	6
9269483	180	271	6
9272133	200	373	6



871

SEITENSCHNEIDER, DIN ISO 5749
DIAGONAL CUTTERS, DIN ISO 5749

Chrom-Molybdän Stahl
verchromt, matt poliert
2-Komponentengriffe

Chrome-Molybdenum steel
chrome plated, matt polished
two component handle

Art.-No.	l-mm-l		
9269493	145	142	6
9272143	160	188	6

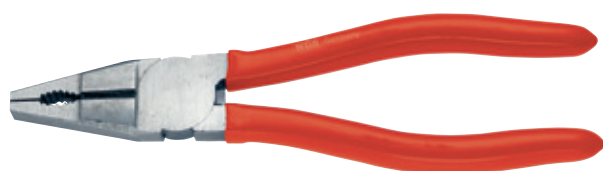



845

KOMBINATIONSZANGE, DIN ISO 5746
COMBINATION PLIERS, DIN ISO 5746

Chrom-Vanadium Stahl
verchromt, Kopf poliert
PVC-getauchte Griffe

Chrome-Vanadium steel
chrome plated, head polished
PVC-dip-coated handle

Art.-No.	l-mm-l		
9230040	160	280	6
9230050	180	234	6
9230060	200	282	6



870

SEITENSCHNEIDER, DIN ISO 5749
DIAGONAL CUTTERS, DIN ISO 5749

Chrom-Vanadium Stahl
verchromt, Kopf poliert
PVC-getauchte Griffe

Chrome-Vanadium steel
chrome plated, head polished
PVC-dip-coated handle

Art.-No.	l-mm-l		
8714500	145	145	6
8706000	160	150	6



861

KRAFTSEITENSCHNEIDER, DIN ISO 5749
HEAVY DUTY DIAGONAL CUTTERS, DIN ISO 5749

Chrom-Molybdän Stahl
verchromt, matt poliert
2-Komponentengriffe

Chrome-Molybdenum steel
chrome plated, matt polished
two component handle

Art.-No.	l-mm-l		
9269513	190	280	6
9272193	200	305	6



892

FLACHRUNDZANGE, DIN ISO 5745
SNIPE NOSE PLIERS, DIN ISO 5745

Chrom-Molybdän Stahl
verchromt, matt poliert
gerade Ausführung
2-Komponentengriffe

Chrome-Molybdenum steel
chrome plated, matt polished
straight pattern
two component handle

Art.-No.	l-mm-l		
9272153	170	162	6
9272163	200	252	6

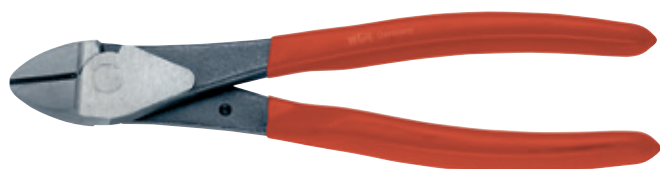

860

KRAFTSEITENSCHNEIDER, DIN ISO 5749
HEAVY DUTY DIAGONAL CUTTERS, DIN ISO 5749

Chrom-Vanadium Stahl
verchromt, Kopf poliert
PVC-getauchte Griffe

Chrome-Vanadium steel
chrome plated, head polished
PVC-dip-coated handle

Art.-No.	l-mm-l		
8601700	170	180	6
8602000	200	299	6

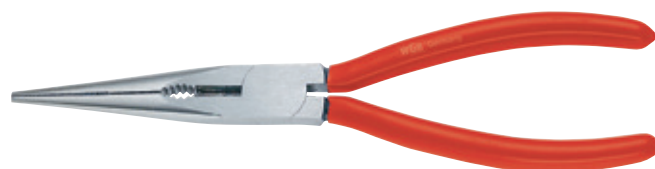

890

FLACHRUNDZANGE, DIN ISO 5745
SNIPE NOSE PLIERS, DIN ISO 5745

Chrom-Vanadium Stahl
verchromt, Kopf poliert
gerade Ausführung
PVC-getauchte Griffe

Chrome-Vanadium steel
chrome plated, head polished
straight pattern
PVC-dip-coated handle

Art.-No.	l-mm-l		
8901700	170	166	6
8902050	200	176	6



893

FLACHRUNDZANGE, DIN ISO 5745 SNIPE NOSE PLIERS, DIN ISO 5745

Chrom-Molybdän Stahl
verchromt, matt poliert
45° abgewinkelte Ausführung
2-Komponentengriffe

Chrome-Molybdenum steel
chrome plated, matt polished
45° bent pattern
two component handle

Art.-No.	l-mm-l		
9272173	160	159	6
9272183	200	266	6

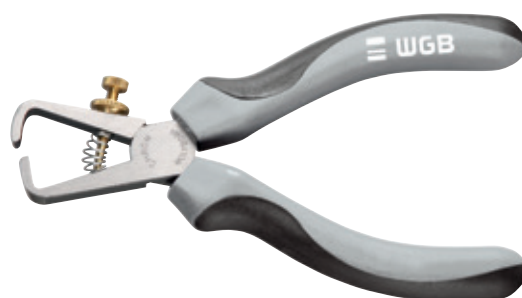

883

ABISOLIERZANGE WIRE STRIPPING PLIERS

Chrom-Molybdän Stahl
verchromt, matt poliert
Messing-Einstellschraube und Feder
2-Komponentengriffe

Chrome-Molybdenum steel
chrome plated, matt polished
brass adjustment screw and spring
two component handle

Art.-No.	l-mm-l		
9269523	160	165	6

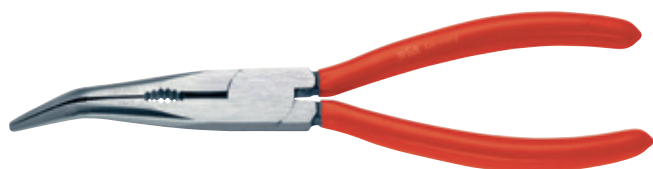

891

FLACHRUNDZANGE, DIN ISO 5745 SNIPE NOSE PLIERS, DIN ISO 5745

Chrom-Vanadium Stahl
verchromt, Kopf poliert
45° abgewinkelte Ausführung
PVC-getauchte Griffe

Chrome-Vanadium steel
chrome plated, head polished
45° bent pattern
PVC-dip-coated handle

Art.-No.	l-mm-l		
9250340	160	115	6
9230020	200	179	6

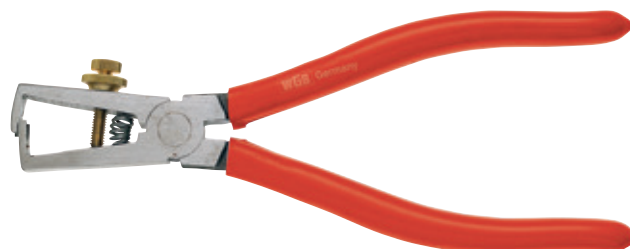

882

ABISOLIERZANGE, DIN ISO 5744 WIRE STRIPPING PLIERS, DIN ISO 5744

Spezial-Werkzeugstahl
verchromt, Kopf poliert
Messing-Einstellschraube und Feder
PVC-getauchte Griffe

Special Carbon steel
chrome plated, head polished
brass adjustment screw and spring
PVC-dip-coated handle

Art.-No.	l-mm-l		
9209530	160	165	6



830

MONTAGEZANGE, DIN 5254 A
CIRCLIP PLIERS, DIN 5245 A

Chrom-Vanadium Stahl
verchromt, Kopf poliert
gerade Ausführung, mit Feder
PVC-getauchte Griffe
für Außensicherungsringe

Chrome-Vanadium steel
chrome plated, head polished
straight pattern, with spring
PVC-dip-coated handle
for external retaining rings

Art.-No.	Größe Size	Ø mm	l-mm-l	g	☐
8300000	A0	3-10	140	92	10
8300010	A1	10-25	140	98	10
8300020	A2	19-60	170	199	6
8300030	A3	40-100	220	271	6
8300040	A4	85-165	320	503	6

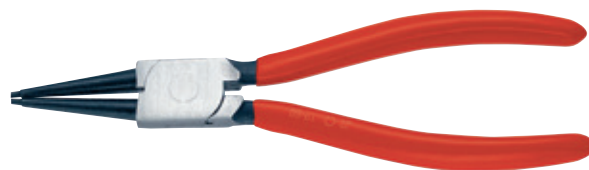

850

MONTAGEZANGE, DIN 5256 C
CIRCLIP PLIERS, DIN 5245 C

Chrom-Vanadium Stahl
verchromt, Kopf poliert
gerade Ausführung
PVC-getauchte Griffe
für Innensicherungsringe

Chrome-Vanadium steel
chrome plated, head polished
straight pattern
PVC-dip-coated handle
for internal retaining rings

Art.-No.	Größe Size	Ø mm	l-mm-l	g	☐
8500000	J0	8-25	140	102	10
8500010	J1	10-25	140	104	10
8500020	J2	19-60	170	172	10
8500030	J3	40-100	220	263	6
8500040	J4	85-165	320	439	6

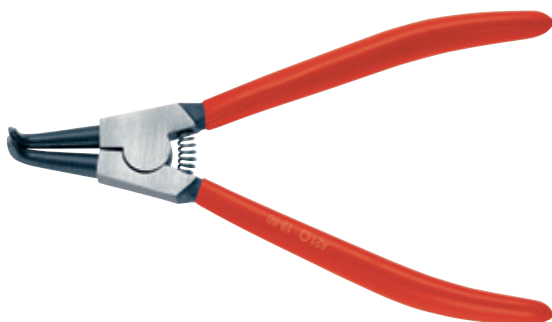

831

MONTAGEZANGE, DIN 5254 B
CIRCLIP PLIERS, DIN 5245 B

Chrom-Vanadium Stahl
verchromt, Kopf poliert
abgewinkelte Ausführung, mit Feder
PVC-getauchte Griffe
für Außensicherungsringe

Chrome-Vanadium steel
chrome plated, head polished
bent pattern, with spring
PVC-dip-coated handle
for external retaining rings

Art.-No.	Größe Size	Ø mm	l-mm-l	g	☐
8300100	A01	3-10	140	97	10
8300110	A11	10-25	140	98	10
8300210	A21	19-60	170	175	6
8300310	A31	40-100	220	260	6
8300410	A41	85-165	320	520	6



851

MONTAGEZANGE, DIN 5256 D
CIRCLIP PLIERS, DIN 5245 D

Chrom-Vanadium Stahl
verchromt, Kopf poliert
abgewinkelte Ausführung
PVC-getauchte Griffe
für Innensicherungsringe

Chrome-Vanadium steel
chrome plated, head polished
bent pattern
PVC-dip-coated handle
for internal retaining rings

Art.-No.	Größe Size	Ø mm	l-mm-l	g	☐
8500100	J01	8-25	140	92	10
8500110	J11	10-25	140	97	10
8500210	J21	19-60	170	167	10
8500310	J31	40-100	220	263	6
8500410	J41	85-165	320	309	6

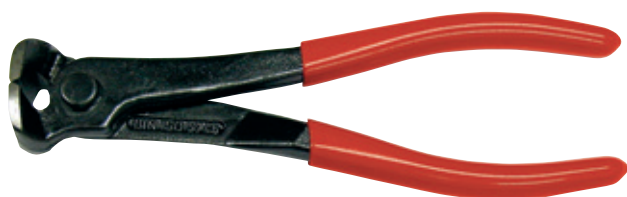

897

VORNSCHNEIDER, DIN ISO 5748
FRONT CUTTERS, DIN ISO 5748

Spezial-Werkzeugstahl Special Carbon steel
Kopf poliert head polished
PVC-getauchte Griffe PVC-dip-coated handle

Art.-No.	l-mm-l	g	☐
9243680	160	185	6
9272260	180	275	6
9270050	200	344	6

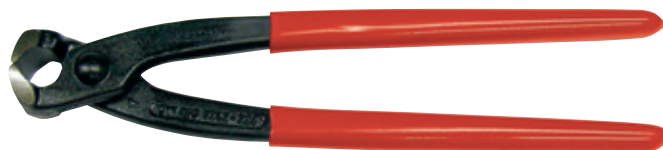

881

RABITZZANGE, DIN ISO 9242
TOWER PINCERS, DIN ISO 9242

Spezial-Werkzeugstahl Special Carbon steel
Kopf poliert head polished
PVC-getauchte Griffe PVC-dip-coated handle

Art.-No.	l-mm-l	g	☐
9230170	220	332	6
9230180	250	425	6
9230190	300	567	6



880

KANTENZANGE, DIN ISO 9243
CARPENTER'S PINCERS, DIN ISO 9243

Spezial-Werkzeugstahl Special Carbon steel
Kopf poliert head polished
PVC-getauchte Griffe PVC-dip-coated handle

Art.-No.	l-mm-l	g	☐
8801600	160	230	6
8801800	180	305	6
8802000	200	423	6
8802500	250	535	6



896

KABELSCHERE
CABLE CUTTERS

Chrom-Vanadium Stahl Chrome-Vanadium steel
verchromt, matt poliert chrome plated, matt polished
Einsatzbereich: Kupfer- und Aluminiumkabel application field: copper and aluminium cables
2-Komponentengriffe mit Öffnungsfeder und -sperre two component handle with opening spring and closing catch

Art.-No.	l-mm-l	g	☐
8961700	170	213	6



801

ADERENDHÜLSENZANGE CRIMPING PLIERS FOR END SLEEVES

Spezial-Werkzeugstahl
Kopf poliert
PVC-getauchte Griffe

Special Carbon steel
head polished
PVC-dip-coated handle

Art.-No.	l-mm-l	∅ mm		
9242770	145	0,5-2,5	129	6
9242760	180	0,5-16,0	242	6





8883

BOLZENSCHNEIDER BOLT CUTTERS

Chrom-Vanadium Stahl
mit auswechsel- und
einstellbarem Messerkopf
Exzenterverstellung

Chrome-Vanadium steel
with exchangeable cutting head
easy jaw adjustment by
excenter bolts

Art.-No.	l-mm-l	∅ mm 40 HRC		
9230200	460	7	1656	1
9230210	620	8	2366	1
9230220	800	9	4540	1
9230230	900	10	4890	1



820

WASSERPUMPENZANGE, DIN ISO 8976 WATER PUMP PLIERS, DIN ISO 8976

Chrom-Vanadium Stahl
mit durchgestecktem Gleitgelenk
7-fach verstellbar
2-Komponentengriffe

Chrome-Vanadium steel
with box joint
7 position adjustment
two component handle



Art.-No.	l-mm-l		
9268850	250	375	6



800

WASSERPUMPENZANGE, DIN ISO 8976 WATER PUMP PLIERS, DIN ISO 8976

Chrom-Vanadium Stahl
mit durchgestecktem Gleitgelenk
7-fach verstellbar
PVC-getauchte Griffe

Chrome-Vanadium steel
with box joint
7 position adjustment
PVC-dip coated handle



Art.-No.	l-mm-l		
8002400	250	390	6



819

WASSERPUMPENZANGE, DIN ISO 8976 WATER PUMP PLIERS, DIN ISO 8976

Chrom-Vanadium Stahl
mit durchgestecktem Gleitgelenk
7-fach verstellbar

Chrome-Vanadium steel
with box joint
7 position adjustment



Art.-No.	l-mm-l		
9229990	175	174	10
9201170	240	333	6
9230000	300	484	6

810

ECKROHRZANGE, DIN 5234
PIPE WRENCH, DIN 5234

Chrom-Vanadium Stahl
45° abgewinkelt, gerades Maul



Chrome-Vanadium steel
45° bent, straight jaw

Art.-No.	∅ max	l-mm-l	g	☐
8100100	1"	315	773	6
8100150	1.1/2"	420	1374	1
8100200	2"	530	2303	1

811

ECKROHRZANGE, DIN 5234
PIPE WRENCH, DIN 5234

Chrom-Vanadium Stahl
45° abgewinkelt, S-Maul



Chrome-Vanadium steel
45° bent, S-jaw

Art.-No.	∅ max	l-mm-l	g	☐
8110120	1/2"	230	411	6
8110100	1"	320	807	6
8111120	1.1/2"	425	1440	1
8110200	2"	540	2390	1
8110300	3"	625	4210	1

812

ECKROHRZANGE, DIN 5234
PIPE WRENCH, DIN 5234

Chrom-Vanadium Stahl
90° abgewinkelt,
Schwedisches Model



Chrome-Vanadium steel
90° bent,
Swedish pattern

Art.-No.	∅ max	l-mm-l	g	☐
8120100	1"	310	739	6
8121120	1.1/2"	420	1335	1
8120200	2"	560	2266	1
8120300	3"	630	2960	1
8120400	4"	750	4920	1





828

UNIVERSAL-GRIP-ZANGE UNIVERSAL GRIP PLIERS

**Chrom-Vanadium Stahl
vernickelt
mit Drahtabschneider
Einsatzbereich: rundes und flaches
Material**

Chrome-Vanadium steel
nickel plated
with wire cutter
application field: round and flat
material

Art.-No.	l-mm-l		
9200166	180	355	5
9200176	250	528	5
9201126	300	923	3



829

IDEAL-GRIP-ZANGE IDEAL GRIP PLIERS

**Chrom-Vanadium Stahl
vernickelt
Einsatzbereich: rundes, flaches,
profiliertes und eckiges Material**

Chrome-Vanadium steel
nickel plated
application field: round, flat,
shaped and square material

Art.-No.	l-mm-l		
9209476	180	370	5
9201136	250	570	5



822

PARALLEL-PLUS-GRIP-ZANGE PARALLEL PLUS GRIP PLIERS

**Chrom-Vanadium Stahl
vernickelt
mit einer schwenkbaren Backe
Einsatzbereich: rundes und flaches
Material**

Chrome-Vanadium steel
nickel plated
with one swivel jaw
application field: round and flat
material

Art.-No.	l-mm-l		
9209486	250	375	6



827

GRIP-ZANGE GRIP PLIERS

**Chrom-Vanadium Stahl
vernickelt
gerade Backen
Einsatzbereich: flaches Material**

Chrome-Vanadium steel
nickel plated
straight jaws
application field: flat material

Art.-No.	l-mm-l		
9201146	250	540	6



823

BREITMAUL-GRIP-ZANGE WIDE JAW GRIP PLIERS

**Spezial-Werkzeugstahl
vernickelt**
Backenbreite 80 mm
Einsatzbereich: flaches Material
und Bleche

Special Carbon steel
nickel plated
jaw width 80 mm
application field: flat material
and sheets

Art.-No.	l-mm-l		
9209496	180	482	1



825

ROHR-SCHWEISSER-GRIP-ZANGE WELDER'S GRIP PLIERS FOR TUBES

**Spezial-Werkzeugstahl
vernickelt**
Spannweite 10-90 mm
Einsatzbereich: Rohr- und
Rundmaterial

Special Carbon steel
nickel plated
jaw width 10-90 mm
application field: pipe and
round material

Art.-No.	l-mm-l		
9201166	280	794	1

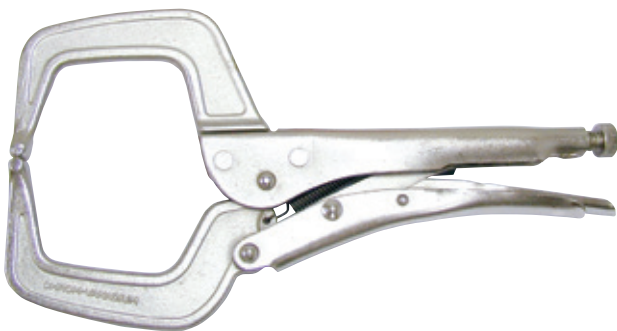

824

KLAMMER-GRIP-ZANGE CLAMP GRIP PLIERS

**Chrom-Vanadium Stahl
vernickelt**
Einsatzbereich: sperrige
Werkstücke und Profilmaterial mit
hohen Stegen

Chrome-Vanadium steel
nickel plated
application field: bulky
workpieces and profile material with
high ridges

Art.-No.	l-mm-l		
9201156	280	702	1
9209506	460	1150	1
9209516	600	1334	1



826

SCHWEISSER-GRIP-ZANGE WELDER'S GRIP PLIERS

**Spezial-Werkzeugstahl
vernickelt**
Spannweite 60 mm
Einsatzbereich: flaches und
Vierkantmaterial

Special Carbon steel
nickel plated
jaw width 60 mm
application field: flat and
square material

Art.-No.	l-mm-l		
9200186	280	798	1



832

LANGBECK-GRIP-ZANGE LONG NOSE GRIP PLIERS

Chrom-Vanadium-Stahl
vernickelt
Spannweite 40 mm
Einsatzbereich: schmal
zulaufende Stellen

Chrome Vanadium steel
nickel plated
jaw width 40 mm
application field: narrow
tapered places

Art.-No.	l-mm-l	g	📦
9270256	165	180	1



833

KETTEN-GRIP-ZANGE CHAIN GRIP PLIERS

Chrom-Vanadium-Stahl
vernickelt
Spannweite 150 mm
Einsatzbereich: große und
unsymmetrische Werkstücke
(auch geeignet zum Lösen
von Ölfiltern)

Chrome Vanadium steel
nickel plated
jaw width 150 mm
application field: large and
asymmetrical workpieces
(also suitable for loosening
oil filters)

Art.-No.	l-mm-l	g	📦
9278466	255	930	1



834

PARALLEL-KLAMMER-GRIPZANGE PARALLEL-CLAMP GRIP PLIERS

Chrom-Vanadium-Stahl
vernickelt
mit beweglichen Backen
Spannweite 90 mm
Einsatzbereich: sperrige und
unsymmetrische Werkstücke

Chrome Vanadium steel
nickel plated
with movable jaws
jaw width 90 mm
application field: bulky and
asymmetrical workpieces

Art.-No.	l-mm-l	g	📦
9278476	280	780	1



835

ERSATZKETTE FÜR KETTEN-GRIPZANGE EXTENSION/REPLACEMENT CHAIN

Spannweite 150 mm

jaw width 150 mm

Art.-No.	l-mm-l	g	📦
9286800	480	315	1



**VERSCHIEDENE
WERKZEUGE
MISCELLANEOUS
TOOLS**

08

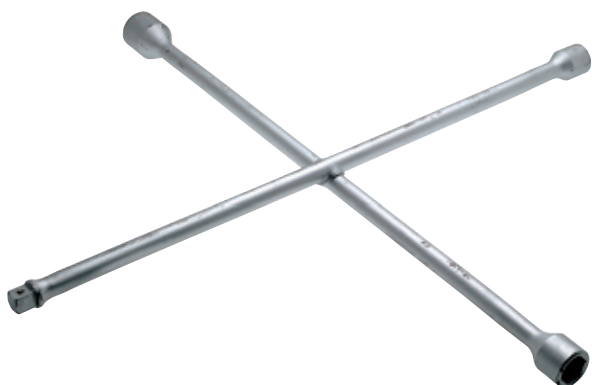

476

KREUZSCHLÜSSEL FÜR LKW 4-WAY WHEEL WRENCH FOR TRUCKS

DIN ISO 691, DIN ISO 1711
Spezial-Werkzeugstahl
gehärtet, verchromt

DIN ISO 691, DIN ISO 1711
Special Carbon steel
hardened, chrome plated

Art.-No.	Ø mm	l mm	g	Box
9210860	19 x 22 x 24 x 27	500	2200	1
9200050	24 x 27 x 30 x 32	700	5000	1
9200060	24 x 27 x 32 x 38	700	5116	1
9236273	24 x 27 x 32 x 3/4"	700	4000	1

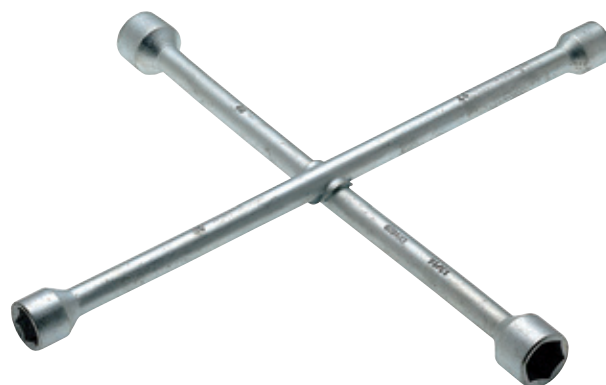

475

KREUZSCHLÜSSEL FÜR PKW 4-WAY WHEEL WRENCH FOR CARS

DIN ISO 691, DIN ISO 1711
Spezial-Werkzeugstahl
gehärtet, verchromt

DIN ISO 691, DIN ISO 1711
Special Carbon steel
hardened, chrome plated

Art.-No.	Ø mm	l mm	g	Box
9244079	17 x 19 x 22 x 32	380	1350	1



380

PROFIL-REIFENHEBER TYRE LEVER

Chrom-Vanadium Stahl
gehärtet, verchromt
gerade Ausführung

Chrome-Vanadium steel
hardened, chrome plated
straight pattern

Art.-No.	l mm	g	Box
3803000	300	500	1
3804000	400	550	1
3805000	500	690	1
3806000	600	993	1



393

MÜTTERNSPRENGER NUT SPLITTER

Body: Chrom-Vanadium Stahl,
verchromt
Kopf: Chrom-Molybdän Stahl,
schwarz

Body: Chrom-Vanadium Stahl,
verchromt
Head: Chrome-Molybdenum steel,
black

Art.-No.	No.			
39309123	1	6-12	86	10
39312163	2	10-16	196	10
39316223	3	13-22	392	5
39322273	4	17-27	650	5
39325323	5	24-32	653	5

5341

STEBBOLZEN EIN- UND AUSDREHER STUD INSERTER AND EXTRACTOR

gerändelt
Spezial-Werkzeugstahl
verzinkt
für Rechts- und Linksgewinde

knurled
Special Carbon steel
zinc plated
for right- and left-thread

Art.-No.	Spannweite (mm) Capacity (mm)		
5341130	4-13	274	1
5341190	8-19	398	1
5341280	17-28	520	1



374

HAND-SCHLAGSCHRAUBER-SATZ IMPACT DRIVER SET



zum Lösen und Festziehen von
Schrauben mit dem Hammer

for losing and fixing
screws by hammer

Handstück: vergüteter Werkzeugstahl
Adapter: Chrom-Vanadium Stahl
im Stahlblechkasten
6-tlg.

Handle: Special Carbon steel
Adaptor: Chrome-Vanadium steel
in metal box
6 pcs.

umstellbar für Rechts- und
Linksgang
im Metallkasten
Antriebsvierkant Nenngröße:
12,5 mm | 1/2"
sehr robust
matt verchromt

use for clock- and counterclockwise
direction
in metal box
square:
12,5 mm | 1/2"
very robust
matt chrome plated

2 Schlitz-Bits aus S2-Stahl: 8 | 10 mm
2 Kreuz-Bits aus S2-Stahl: PH2 | PH3

2 slot bits of S2 steel: 8 | 10 mm
2 cross bits of S2 steel: PH2 | PH3

534

SCHRAUBENAUSDREHER-SATZ SCREW EXTRACTOR SET

Chrom-Molybdän Stahl
verchromt
in Kunststoffbox

Chrome-Molybdenum steel
chrome plated
in plastic box

Art.-No.	No.			
9202740	5	M3-M18	112	1
9202750	6	M3-M24	225	1
9202760	8	M3-M50	740	1

Art.-No.	H x B x T (mm) H x W x L (mm)		
9290230	45 x 195 x 65	1025	1





8661

BANDSCHLÜSSEL STRAP WRENCH

rutschfestes Gewebeband
Chrom-Vanadium Stahl
verchromt
geschmiedeter Griff

anti-slip textile strap
Chrome-Vanadium steel
chrome plated
forged handle

Art.-No.	Spannweite (mm) Capacity (mm)	l-mm-i		
86612403	240	240	350	1





8721

UNIVERSAL-FILTERSCHLÜSSEL UNIVERSAL FILTER WRENCH

verstellbar
Spezial-Werkzeugstahl
vernickelt
Kunststoffgriff

adjustable
Special Carbon steel
nickel plated
plastic handle

Art.-No.	Spannweite (mm) Capacity (mm)	l-mm-i		
87210756	70-75	210	280	1
87210956	85-95	220	285	1





8723

UNIVERSAL-FILTERSCHLÜSSEL UNIVERSAL FILTER WRENCH

verstellbar mit Zahnung
Spezial-Werkzeugstahl
vernickelt
1/2" [12,5 mm] Betätigungsvierkant

adjustable with ratchet action
Special Carbon steel
nickel plated
1/2" [12,5 mm] square drive

Art.-No.	Spannweite (mm) Capacity (mm)		l-mm-i		
87230806	65-80	5	140	188	1
87231106	80-110	7	160	222	1





8722

UNIVERSAL-FILTERSCHLÜSSEL UNIVERSAL FILTER WRENCH

verstellbar mit Zahnung
Spezial-Werkzeugstahl
vernickelt
Kunststoffgriff

adjustable with ratchet action
Special Carbon steel
nickel plated
plastic handle

Art.-No.	Spannweite (mm) Capacity (mm)		l-mm-i		
87221106	75-110	7	230	320	1

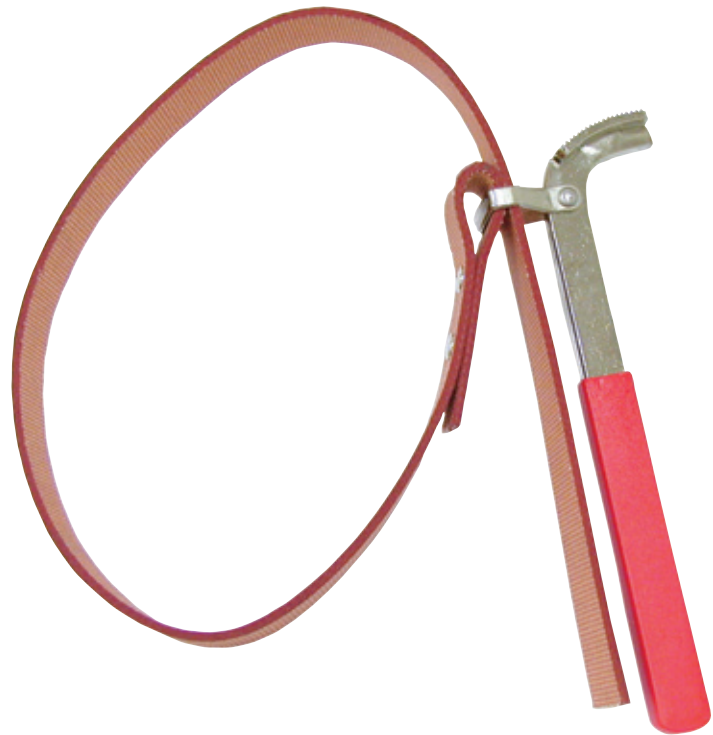



866

BANDSCHLÜSSEL STRAP WRENCH

rutschfestes Gewebeband
Spezial-Werkzeugstahl
vernickelt
Kunststoffgriff

anti-slip textile strap
Special Carbon steel
nickel plated
plastic handle



Art.-No.	Spannweite (mm) Capacity (mm)	l-mm-l		
9203016	240	230	316	1

684

ÖLFILTER ABZIEHER OIL FILTER REMOVER

verstellbar
Chrom-Vanadium Stahl
verchromt
Kunststoffgriff

adjustable
Chrome-Vanadium steel
chrome plated
plastic handle

Art.-No.	Spannweite (mm) Capacity (mm)	l-mm-l		
6840001	65-105	300	214	1









4903

UNIVERSAL-ABZIEHER UNIVERSAL PULLER

3-armig
Chrom-Vanadium Stahl | verzinkt
2-stufig längenverstellbar
durch Umdrehen als Innen- und
Außenabzieher verwendbar

3-armed
Chrome-Vanadium steel | zinc plated
2-stage length-adjustable
can be used as internal and
external puller by turning it over

Art.-No.	 mm	 mm	 g	
49030850	85	85	432	1
49031200	120	120	680	1
49031600	160	145	1210	1







497

UNIVERSAL-ABZIEHER UNIVERSAL PULLER

3-armig
Chrom-Vanadium Stahl | verchromt
2-stufig längenverstellbar
durch Umdrehen als Innen- und
Außenabzieher verwendbar

3-armed
Chrome-Vanadium steel | chrome plated
2-stage length-adjustable
can be used as internal and
external puller by turning it over

Art.-No.	 mm	 mm	 g	
9295753	110	150	1300	1







490

UNIVERSAL-ABZIEHER UNIVERSAL PULLER

2-armig
Chrom-Vanadium Stahl
verzinkt
durch Umdrehen als Innen- und
Außenabzieher verwendbar

2-armed
Chrome-Vanadium steel
zinc plated
can be used as internal and
external puller by turning it over

Art.-No.	 mm	 mm	 g	
4901200	120	100	986	1
4901600	160	150	2618	1
4902000	200	150	2828	1







498

UNIVERSAL-ABZIEHER UNIVERSAL PULLER

2-armig
Chrom-Vanadium Stahl | verchromt
2-stufig längenverstellbar
durch Umdrehen als Innen- und
Außenabzieher verwendbar

2-armed
Chrome-Vanadium steel | chrome plated
2-stage length-adjustable
can be used as internal and
external puller by turning it over

Art.-No.	 mm	 mm	 g	
9293733	135	110	840	1



391

FÜHLERLEHRE FEELER GAUGE

Einsatz in der Motorenindustrie und zum Lichtspaltmessen geeignet

Lehrenblätter aus gehärtetem Federstahl

konische Blattform

vernickeltes Deckblatt

Feststellschraube

Maßangaben in mm und Zoll auf jedem Lehrenblatt

for thickness measurement between narrow slots and for automotive industry



hardened spring steel

conical shaped blades

nickel plated case

lock nut

sizes marked in mm and inch on each blade

Art.-No.	Set-Nr. Set-No.	Größe (mm) Range (mm)		
9203030	391/8	0,05 0,10 0,15 0,20 0,25 0,30 0,40 0,50	30	10
9203040	391/13	0,05 0,10 0,15 0,20 0,25 0,30 0,40 0,50 0,60 0,70 0,80 0,90 1,00	60	10
9203050	391/20	0,05 0,10 0,15 0,20 0,25 0,30 0,35 0,40 0,45 0,50 0,55 0,60 0,65 0,70 0,75 0,80 0,85 0,90 0,95 1,00	90	10
9291800	391/21	0,05 0,10 0,20 0,30 0,40 0,50 0,60 0,70 0,80 0,90 1,00 1,10 1,20 1,30 1,40 1,50 1,60 1,70 1,80 1,90 2,00	89	10



421

AUTOLICHTPRÜFER AUTOMOTIVE LIGHT TESTER

Messing

festes Kabel

Krokodilklemme und Spitze



6-24 V

Brass

fixed cable

Alligator clip and tip

6-24 V

Art.-No.	 mm	l mm-i		
9234800	12	120	64	10



409

FLEXIBLER MAGNETHEBER FLEXIBLE MAGNETIC LIFTER

Tragkraft bis 270 g

flexibler Schaft

mit sehr dünner 4 mm

Magnetaufnahme

mit Kunststoffgriff



load capacity to 270 g

flexible shaft

with a very thin magnetic

head 4 mm

with plastic handle

Art.-No.	 mm	l mm-i		
9301640	5,4	400	21	10



411

ZÜNDKERZEN-SCHLÜSSEL SPARK PLUG SOCKET WRENCH

DIN ISO 691
Stahlrohr
verchromt

DIN ISO 691
pipe steel
chrome plated

Art.-No.	mm	l-mm-l	g	
9243773	16 x 21	150	155	10



417

RADMUTTER- UND ZÜNDKERZEN-SCHLÜSSEL SPARK PLUG SOCKET WRENCH

DIN ISO 691
mit Drehstift 8 x 150 mm
Stahlrohr
verchromt

DIN ISO 691
with tommy bar 8 x 150 mm
pipe steel
chrome plated

Art.-No.	mm	l-mm-l	g	
9243983	16 x 21	150	202	10



872

UNIVERSALSCHLÜSSEL FÜR VENTILNIPPEL UNIVERSAL WRENCH FOR VALVES

DIN 2725-1, DIN 3120 C,
ISO 1174-1
Chrom-Vanadium Stahl
verchromt

DIN 2725-1, DIN 3120 C,
ISO 1174-1
Chrome-Vanadium steel
chrome plated



Art.-No.	mm	l-mm-l	g	
9291113	3/8" 1/2" 3/4" 1" 1.1/4"	112	234	5



873

SANITÄR-MONTAGESCHLÜSSEL INSTALLATION WRENCH

DIN ISO 1085, ISO 3318,
ISO 10102
Chrom-Vanadium Stahl
verchromt
zur Befestigung von Waschtischen
und Eckventilen
für Stockschrauben M10

DIN ISO 1085, ISO 3318,
ISO 10102
Chrome-Vanadium steel
chrome plated
to fix washstands
and angle valves
for stair bolts M10

Art.-No.	mm	l-mm-l	g	
9236149	17 x 19	215	257	5



394

REISSNADEL MIT HARTMETALLSPITZE SCRIBER TUNGSTEN CARBIDE TIPPED

mit Taschenclip

with pocket clip

Art.-No.	l-mm-l		
9234910	150	36	10



966

TASCHENMESSCHIEBER VERNIER CALLIPERS

Spezial-Werkzeugstahl
Ablesung in cm/inch Skala geätzt
Nonius-Schieber aufgeschraubt
im Etui

Special Carbon steel
etched cm/inch scale
screwed-on nonius
in case

Art.-No.	l-mm-l		
9283113	150	150	1



414

ZIMMERMANN'S BLEISTIFT CARPENTER'S PENCIL

oval

oval

Art.-No.	l-mm-l		
9286610	200	190	1



416

ZOLLSTOCK FOLDING RULE

Holz

wood

Art.-No.	l-mm-l		
9294090	2000 [2 m]	100	1



419

WASSERWAAGE WATER LEVEL

Aluminium
silber eloxiert

Aluminium
silver anodised

Art.-No.	l-mm-l		
9294080	400	235	1



418

TASCHENROLLBANDMASS POCKET MEASURING TAPE

robuste Bandmechanik
automatischer Bandrücklauf mit
Stopper
Gürtelclip
hochschlagfester ABS-Kunststoff
in 2-Komponentenausführung

robust belt mechanism
automatic blade return with
blade lock
belt clip
high-impact ABS-plastic
in a 2-component version

Art.-No.	Bandbreite (mm) Band width (mm)	L x B x H (mm) L x W x H (mm)	l-mm-l		
9304700	16	60 x 60 x 32	3000 [3 m]	177	10

715

SCHLOSSERHAMMER, DIN 1041 MACHINIST'S HAMMER, DIN 1041

Hammerkopf geschmiedet
mit Stielschutz
Hickorystiel doppelt geschweift

forged head
with handle protection
hickory handle double flared

Art.-No.	g	l-mm-l	g	
7150300	300	300	400	6
7150400	400	310	460	6
7150500	500	350	560	6
7151000	1000	360	1175	1
7151500	1500	380	1660	1



717

SCHLOSSERHAMMER, DIN 1041 MACHINIST'S HAMMER, DIN 1041

VPA-GS geprüft
Hammerkopf geschmiedet
Fiberglasstiel

VPA-GS tested
forged head
fibre glass handle

Art.-No.	g	l-mm-l	g	
7170200	200	280	275	6
7170300	300	300	400	6
7170400	400	310	460	6
7170500	500	320	560	6
7170800	800	350	1000	6
7171000	1000	360	1175	6
7171500	1500	380	1660	6
7172000	2000	400	2235	6



719

NYLONSCHUTZ NYLON HEAD

für Schlosserhammer

for Machinist's Hammer

Art.-No.	g	g	
9295120	300	23	1
9261480	500	55	1
9295190	800	50	1





960

VORSCHLAGHAMMER, DIN 1042 SLEDGE HAMMER, DIN 1042

Hammerkopf geschmiedet
Eschenstiel doppelt geschweift
gesichert durch Ringkeil

forged head
ash handle double flared
secured with ring wedge

Art.-No.	g	l-mm-l	g	
9603000	3000	600	3400	1
9604000	4000	700	4400	1
9605000	5000	700	5500	1
9606000	6000	800	6500	1
9608000	8000	900	8600	1
9610000	10000	900	10600	1



705

KUPFERHAMMER COPPER HAMMER

Hammerkopf geschmiedet
Eschenstiel

forged head
ash handle

Art.-No.	g	l-mm-l	g	
70503000	300	280	378	1
70505000	500	310	621	1
70507500	750	330	910	1



947

LATTHAMMER ROOFING HAMMER

VPA-GS geprüft
Spezial-Werkzeugstahl
2-Komponentenheft

VPA-GS tested
Special Carbon steel
two component handle

Art.-No.	l-mm-l	g	
94708000	320	905	1



718

GIPSERBEIL PLASTER'S HATCHED HAMMER

VPA-GS geprüft
Stahlrohr aus Qualitätsstahl
Kunststoffheft

VPA-GS tested
pipe steel
plastic handle

Art.-No.	l-mm-l	g	
7180850	320	700	1



935

HANDFÄUSTEL, DIN 6475
MINING SLEDGE HAMMER, DIN 6475

Hammerkopf geschmiedet
mit Stielschutz
Hickorstiel doppelt geschweift

forged head
with handle protection
hickory handle double flared

Art.-No.	g	mm	g	
9351000	1000	260	1175	1
9351250	1250	260	1380	1
9351500	1500	280	1705	1
9352000	2000	300	2200	1



937

HANDFÄUSTEL, DIN 6475
MINING SLEDGE HAMMER, DIN 6475

VPA-GS geprüft
Hammerkopf geschmiedet
Fiberglasstiel

VPA-GS tested
forged head
fibre-glass handle

Art.-No.	g	mm	g	
9371000	1000	260	1175	1
9371250	1250	260	1380	1
9371500	1500	280	1705	1
9372000	2000	300	2205	1

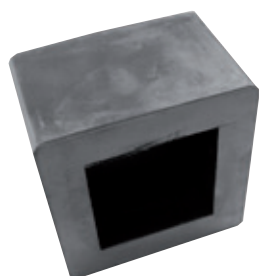

936

GUMMIAUFSATZ FÜR HANDFÄUSTEL
RUBBER ATTACHMENT FOR MINING SLEDGE HAMMER

Gummi Rubber

Art.-No.	g	g	
9295240	1000	400	1
9295250	1250	400	1
9295260	1500	400	1
9295270	2000	400	1



983

PLATTENLEGERHAMMER, DIN 6475
PAVER'S HAMMER, DIN 6475

VPA-GS geprüft
Hammerkopf geschmiedet
Eschenstiel doppelt geschweift
mit Stielschutz, doppelt gesichert
durch Ringkeilbefestigung
mit losem Gummiaufsatz

VPA-GS tested
forged head
ash handle double flared
double secured with ring wedge
and plastic fixing
with moveable rubber head

Art.-No.	g	mm	g	
9831000	1000	260	1575	1
9831250	1250	260	1780	1
9831500	1500	300	2105	1
9832000	2000	300	2605	1



950

GUMMIHAMMER, DIN 5128 A
RUBBER HAMMER, DIN 5128 A

Eschenstiel ash handle

Art.-No.	∅ mm	l mm	g	Box
9500550	55	330	510	1
9500650	65	340	717	1
9500750	75	370	1005	1



710

KUNSTSTOFF-HAMMER
PLASTIC FACED HAMMER

Eschenstiel lackiert mit austauschbaren Köpfen
schlagfestes Cellulose-Acetat
lacquered ash handle with replaceable heads
shatterproof Cellulose-Acetate

Art.-No.	∅ mm	l mm	g	Box
7102700	27	265	233	4
7103200	32	280	331	4
7104000	40	320	557	4
7105000	50	340	862	1
7106000	60	376	1332	1



706

RÜCKSCHLAGFREIER SCHONHAMMER
RECOIL FREE SOFT FACED HAMMER

mit Stahlrohr-Stiel und Kunststoffgriff
rückschlagfrei durch Stahlschrot im Kopfhohlraum
bis zu 100% höhere Schlagwirkung gegenüber normalen Schonhämmern
splitterfrei und verschleißfest
Kunststoff-Köpfe nicht austauschbar für gesundheitsschonendes Arbeiten
with steel tube handle and plastic handle
shock absorbing effect through steel shot in the head
up to 100% higher impact effect than normal Soft Faced Hammers
shatterproof and wear resistant
plastic heads not interchangeable for safer working

Art.-No.	∅ mm	l mm	g	Box
9298710	35	305	646	1



720

ERSATZKOPF
SPARE HEAD

für Kunststoff-Hammer Nr. 710
schlagfestes Cellulose-Acetat
for Plastic Faced Hammer No. 710
shatterproof Cellulose-Acetate

Art.-No.	∅ mm	g	Box
7202700	27	15	10
7203200	32	29	10
7204000	40	40	10
7205000	50	68	5



750

FLACHMEISSEL, DIN 6453
FLAT CHISEL, DIN 6453

Chrom-Vanadium Lufthärtestahl
lackiert

Chrome-Vanadium air hardened steel
lacquered

Art.-No.	l-mm-l	mm	g	
7512500	125	14 x 9	101	10
7515000	150	17 x 11	172	10
7517500	175	20 x 12	264	10
7520000	200	23 x 13	371	10
7525000	250	23 x 13	473	10
7530000	300	23 x 13	586	10



731

MAURERMEISSEL, DIN 7254 A
MASON'S CHISEL, DIN 7254 A

Chrom-Vanadium Lufthärtestahl
lackiert

Chrome-Vanadium air hardened steel
lacquered

Art.-No.	l-mm-l	mm	g	
9202770	250	20 x 12	382	5
9202780	300	23 x 13	592	5
9202790	350	23 x 13	701	5
9202800	400	23 x 13	795	5



730

KREUZMEISSEL, DIN 6451
CROSSCUT CHISEL, DIN 6451

Chrom-Vanadium Lufthärtestahl
lackiert

Chrome-Vanadium air hardened steel
lacquered

Art.-No.	l-mm-l	mm	g	
7312500	125	17 x 11	91	10
7315000	150	17 x 11	160	10
7317500	175	20 x 12	260	10
7320000	200	20 x 12	277	10
7325000	250	23 x 13	382	5



732

SPITZMEISSEL, DIN 7256
POINTED CHISEL, DIN 7256

Chrom-Vanadium Lufthärtestahl
lackiert

Chrome-Vanadium air hardened steel
lacquered

Art.-No.	l-mm-l	mm	g	
9202810	250	16	331	10
9202820	300	18	565	5
9202830	350	18	657	5
9202840	400	20	969	5



733

SCHLITZMEISSEL SLITTING CHISEL

DIN 7255
Chrom-Vanadium Lufthärtestahl
lackiert

DIN 7255
Chrome-Vanadium air hardened steel
lacquered

Art.-No.	l-mm-l	mm	g	
9202850	240	26 x 7	302	10



733 HS

SCHLITZMEISSEL MIT SICHERHEITS-HANDSCHUTZ SLITTING CHISEL WITH PROTECTIVE HAND GUARD

DIN 7255
Chrom-Vanadium Lufthärtestahl
lackiert

DIN 7255
Chrome-Vanadium air hardened steel
lacquered

Art.-No.	l-mm-l	mm	g	
9258650	240	26 x 7	422	5



734

ELEKTRIKERMEISSEL ELECTRICIAN'S CHISEL

DIN 7255
Chrom-Vanadium Lufthärtestahl
lackiert

DIN 7255
Chrome-Vanadium air hardened steel
lacquered

Art.-No.	l-mm-l	mm	g	
9202860	200	8	94	10
9202870	250	10	176	10
9202880	300	10	226	10



735

FUGENMEISSEL JOINTING CHISEL

DIN 7255
Chrom-Vanadium Lufthärtestahl
lackiert

DIN 7255
Chrome-Vanadium air hardened steel
lacquered

Art.-No.	l-mm-l	mm	g	
7350500	250	50	498	5
7350600	250	60	498	5
7350750	250	75	550	5

754

HANDSCHUTZ PROTECTIVE HAND GUARD

für Flachprofil 20 x 12 - 26 x 13 mm
für Achtkant-Material 16-20 mm

for flat profiles 20 x 12 - 26 x 13 mm
for octagonal profile 16-20 mm

Art.-No.	l-mm-l	g	
9230250	110	120	1





760

DURCHTREIBER, DIN 6458
SECTION PUNCH, DIN 6458

Chrom-Vanadium Lufthärtestahl
lackiert

Chrome-Vanadium air hardened steel
lacquered

Art.-No.	∅ mm	l mm	∅ mm	g	Box
7610020	2	120	10	61	10
7610030	3	120	10	62	10
7610040	4	120	10	63	10
7610050	5	120	10	65	10
7610060	6	120	10	67	10
7610070	7	120	12	93	10
7610080	8	120	12	100	10
7610090	9	120	12	110	10
7610100	10	120	12	128	10
7610120	12	150	14	179	10



770

SPLINTENTREIBER, DIN 6450
PARALLEL PIN PUNCH, DIN 6450

Chrom-Vanadium Lufthärtestahl
lackiert

Chrome-Vanadium air hardened steel
lacquered

Art.-No.	∅ mm	l mm	∅ mm	g	Box
7700150	1,5	150	10	65	10
7700200	2	150	10	70	10
7700300	3	150	10	68	10
7700400	4	150	10	64	10
7700500	5	150	10	67	10
7700600	6	150	10	71	10
7700700	7	150	12	103	10
7700800	8	150	12	107	10
7701000	10	150	12	120	10
7701200	12	150	14	174	10



740

KÖRNER, DIN 7250
CENTRE PUNCH, DIN 7250

Chrom-Vanadium Lufthärtestahl
lackiert

Chrome-Vanadium air hardened steel
lacquered

Art.-No.	∅ mm	l mm	∅ mm	g	Box
7401200	4	120	10	64	10
7401210	5	120	12	93	10
7401500	6	150	12	117	10



772

NIETENZIEHER
RIVET SET

Chrom-Vanadium Lufthärtestahl
Schaft lackiert, Kopf poliert
durchgängig gehärtet
mit vergütetem
Sicherheitsschlagkopf

Chrome-Vanadium air hardened steel
shaft lacquered, head polished
continuous hardened
with tempered
casing head

Art.-No.	∅ mm	l mm	g	Box
9259900	5	110	135	10
9259910	6	110	135	10

776

NIETENKOPFMACHER
RIVET HEADER

Chrom-Vanadium Lufthärtestahl
Schaft lackiert, Kopf poliert
durchgängig gehärtet
mit vergütetem
Sicherheitsschlagkopf

Chrome-Vanadium air hardened steel
shaft lacquered, head polished
continuous hardened
with tempered
casing head

Art.-No.	∅ mm	l mm	g	Box
9259920	5	110	135	10
9259930	6	110	175	10



770 KH

SPLINTENTREIBER-SATZ, DIN 6450
PARALLEL PIN PUNCH SET, DIN 6450

Chrom-Vanadium Lufthärtestahl
lackiert
im Kunststoffhalter

Chrome-Vanadium air hardened steel
lacquered
in plastic holder







770 MK

SPLINTENTREIBER-SATZ, DIN 6450
PARALLEL PIN PUNCH SET, DIN 6450

Chrom-Vanadium Lufthärtestahl
lackiert
in Metallkassette

Chrome-Vanadium air hardened steel
lacquered
in metal box

Art.-No.	No.	∅ mm		
7700010	770KH/6	2 3 4 5 6 8	500	1
9201490	770KH/06	3 4 5 6 8 10	539	1

Art.-No.	No.	∅ mm		
9267710	770MK/6	2 3 4 5 6 8	500	1
9230290	770MK/06	3 4 5 6 8 10	764	1

770 KK

SPLINTENTREIBER-SATZ, DIN 6450
PARALLEL PIN PUNCH SET, DIN 6450

Chrom-Vanadium Lufthärtestahl
lackiert
in Kunststoffkassette

Chrome-Vanadium air hardened steel
lacquered
in plastic case



759 KH

WERKZEUGSATZ KÖRNER-DURCHTREIBER
PUNCH SET



DIN 6453, DIN 7250, DIN 6458
Chrom-Vanadium Lufthärtestahl
lackiert
6-tlg.
im Kunststoffhalter



DIN 6453, DIN 7250, DIN 6458
Chrome-Vanadium air hardened steel
lacquered
6 pcs.
in plastic holder

Körner 120 x 10 mm
Durchtreiber 120 x 10 x 2 |
120 x 10 x 3 | 120 x 12 x 4 |
120 x 10 x 5 | 120 x 10 x 6 mm

Centre Punch 120x10 mm
Section Punch 120 x 10 x 2 |
120 x 10 x 3 | 120 x 12 x 4 |
120 x 10 x 5 | 120 x 10 x 6 mm



Art.-No.	No.	∅ mm		
9250480	770KK/06	3 4 5 6 8 10	576	1

Art.-No.		
7590010	615	1



753 KH

WERKZEUGSATZ MEISSEL-KÖRNER-DURCHTREIBER CHISEL AND PUNCH SET

DIN 6453, DIN 7250, DIN 6458, DIN 6451
Chrom-Vanadium Lufthärtestahl
lackiert
6-tlg. | im Kunststoffhalter

DIN 6453, DIN 7250, DIN 6458, DIN 6451
Chrome-Vanadium air hardened steel
lacquered
6 pcs. | in plastic holder

Kreuzmeißel 125 x 10 mm
Körner 120 x 10 mm
Durchtreiber 120 x 10 x 3 |
120 x 12 x 4 mm
Flachmeißel 125 x 10 | 150 x 12 mm

Crosscut Chisel 125 x 10 mm
Centre Punch 120 x 10 mm
Section Punch 120 x 10 x 3 |
120 x 12 x 4 mm
Flat Chisel 125 x 10 | 150 x 12 mm

Art.-No.		
9201470	543	1

753 MK

WERKZEUGSATZ MEISSEL-KÖRNER-DURCHTREIBER CHISEL AND PUNCH SET

DIN 6453, DIN 7250, DIN 6458, DIN 6451
Chrom-Vanadium Lufthärtestahl
lackiert
6-tlg. | in Metallkassette

DIN 6453, DIN 7250, DIN 6458, DIN 6451
Chrome-Vanadium air hardened steel
lacquered
6 pcs. | in metal box

Kreuzmeißel 125 x 10 mm
Körner 120 x 10 mm
Durchtreiber 120 x 10 x 3 |
120 x 12 x 4 mm
Flachmeißel 125 x 10 | 150 x 12 mm

Crosscut Chisel 125 x 10 mm
Centre Punch 120 x 10 mm
Section Punch 120 x 10 x 3 |
120 x 12 x 4 mm
Flat Chisel 125 x 10 | 150 x 12 mm

Art.-No.		
9230280	792	1



753 KK

WERKZEUGSATZ MEISSEL-KÖRNER-DURCHTREIBER CHISEL AND PUNCH SET

DIN 6453, DIN 7250, DIN 6458, DIN 6451
Chrom-Vanadium Lufthärtestahl
lackiert
6-tlg. | in Kunststoffkassette

DIN 6453, DIN 7250, DIN 6458, DIN 6451
Chrome-Vanadium air hardened steel
lacquered
6 pcs. | in plastic case

Kreuzmeißel 125 x 10 mm
Körner 120 x 10 mm
Durchtreiber 120 x 10 x 3 |
120 x 12 x 4 mm
Flachmeißel 125 x 10 | 150 x 12 mm

Crosscut Chisel 125 x 10 mm
Centre Punch 120 x 10 mm
Section Punch 120 x 10 x 3 |
120 x 12 x 4 mm
Flat Chisel 125 x 10 | 150 x 12 mm

Art.-No.		
9250490	640	1

758 KH

WERKZEUGSATZ MEISSEL-KÖRNER-DURCHTREIBER CHISEL AND PUNCH SET

DIN 6453, DIN 7250, DIN 6458, DIN 6451
Chrom-Vanadium Lufthärtestahl
lackiert
6-tlg. | im Kunststoffhalter

DIN 6453, DIN 7250, DIN 6458, DIN 6451
Chrome-Vanadium air hardened steel
lacquered
6 pcs. | in plastic holder

Kreuzmeißel 125 x 10 mm
Körner 120 x 10 mm
Durchtreiber 120 x 10 x 2 |
120 x 12 x 4 mm
Flachmeißel 125 x 10 | 150 x 12 mm

Crosscut Chisel 125 x 10 mm
Centre Punch 120 x 10 mm
Section Punch 120 x 10 x 3 |
120 x 12 x 4 mm
Flat Chisel 125 x 10 | 150 x 12 mm

Art.-No.		
7580010	615	1







900

DREIKANTFEILE
TRIANGULAR FILE

Spezial-Werkzeugstahl
2-Komponentenheft
mit Aufhängeloch
Härte 60-62 HRC

Special Carbon steel
two component handle
with hanging hole
hardness 60-62 HRC

Art.-No.	Größe Size		l-mm-l		
9002000	Hieb 2 Cut 2	200	320	540	6





901

VIERKANTFEILE
SQUARE FILE

Spezial-Werkzeugstahl
2-Komponentenheft
mit Aufhängeloch
Härte 60-62 HRC

Special Carbon steel
two component handle
with hanging hole
hardness 60-62 HRC

Art.-No.	Größe Size		l-mm-l		
9012000	Hieb 2 Cut 2	200	320	510	6





902

RUNDFEILE
ROUND FILE

Spezial-Werkzeugstahl
2-Komponentenheft
mit Aufhängeloch
Härte 60-62 HRC

Special Carbon steel
two component handle
with hanging hole
hardness 60-62 HRC

Art.-No.	Größe Size		l-mm-l		
9022000	Hieb 2 Cut 2	200	320	500	6





903

HALBRUNDFEILE
HALF-ROUND FILE

Spezial-Werkzeugstahl
2-Komponentenheft
mit Aufhängeloch
Härte 60-62 HRC

Special Carbon steel
two component handle
with hanging hole
hardness 60-62 HRC

Art.-No.	Größe Size		l-mm-l		
9032000	Hieb 2 Cut 2	200	320	750	6





904

FLACHFEILE FLAT FILE

Spezial-Werkzeugstahl
2-Komponentenheft
mit Aufhängeloch
Härte 60-62 HRC

Special Carbon steel
two component handle
with hanging hole
hardness 60-62 HRC



Art.-No.	Größe Size		l-mm-l		
9042000	Hieb 2 Cut 2	200	320	580	6

905

RUNDRASPEL ROUND RASP

Spezial-Werkzeugstahl
2-Komponentenheft
mit Aufhängeloch
Härte 60-62 HRC

Special Carbon steel
two component handle
with hanging hole
hardness 60-62 HRC

Art.-No.	Größe Size		l-mm-l		
9052500	Hieb 2 Cut 2	250	400	760	6





906

HALBRUNDRASPEL HALF-ROUND RASP

Spezial-Werkzeugstahl
2-Komponentenheft
mit Aufhängeloch
Härte 60-62 HRC

Special Carbon steel
two component handle
with hanging hole
hardness 60-62 HRC

Art.-No.	Größe Size		l-mm-l		
9062500	Hieb 2 Cut 2	250	400	860	6



907 K



FEILENSATZ FILE SET

Spezial-Werkzeugstahl
2-Komponentenheft
mit Aufhängeloch
Härte 60-62 HRC
5-tlg.
im Karton

Special Carbon steel
two component handle
with hanging hole
hardness 60-62 HRC
5 pcs.
in cardboard box

Dreieckfeile Hieb 2
Vierkantfeile Hieb 2
Rundfeile Hieb 2
Halbrundfeile Hieb 2
Flachfeile Hieb 2

Triangular File Cut 2
Square File Cut 2
Round File Cut 2
Half-Round File Cut 2
Flat File Cut 2

Art.-No.	No.	H x B x T (mm) H x W x L (mm)		
9070010	907K/5	50 x 383 x 126	2880	1

771

HENKELLOCHEISEN, DIN 7200 A WAD PUNCH, DIN 7200 A

Spezialstahl gehärtet
pulverbeschichtet
innen konisch
polierte Pfeifen

Special steel hardened
powder coated
conical shape inside
head polished



Art.-No.	∅ mm	∅ AF"	l-mm-l	g	☐
7710020	2	1/16"	100	41	10
7710030	3	1/8"	100	43	10
7710040	4	5/32"	100	43	10
7710050	5	3/16"	100	56	10
7710060	6	7/32"	100	56	10
7710070	7	1/4"	100	50	10
7710080	8	5/16"	112	82	10
7710090	9	11/32"	112	79	10
7710100	10	3/8"	115	78	10
7710110	11	7/16"	122	107	10
7710120	12	15/32"	122	107	10

Weitere Größen auf Anfrage

Art.-No.	∅ mm	∅ AF"	l-mm-l	g	☐
7710130	13	1/2"	135	107	10
7710140	14	9/16"	135	148	10
7710150	15	19/32"	135	144	10
7710160	16	5/8"	135	144	10
7710170	17	21/32"	135	141	10
7710180	18	11/16"	143	185	10
7710190	19	3/4"	143	185	10
7710200	20	25/32"	155	180	10
7710220	22	7/8"	160	313	5
7710250	25	1"	170	388	5
7710300	30	1.3/16"	190	575	2

Other sizes on request



771 HK

HENKELLOCHEISEN-SATZ, DIN 7200 A WAD PUNCH SET, DIN 7200 A

Spezialstahl gehärtet
pulverbeschichtet
in Holzkassette

Special steel hardened
powder coated
in wood case

Art.-No.	No.	∅ mm	g	☐
7711100	771HK/10	2 4 6 8 10 12 14 16 18 20	1300	1
7711190	771HK/19	2 3 4 5 6 7 8 9 10 11 12 13 14 15 16 17 18 19 20	2626	1



783

STECHBEITEL, DIN 5139 FIRMER CHISEL, DIN 5139

ISO 2729
Chrom-Vanadium Stahl
Hartholzheft

ISO 2729
Chrome-Vanadium steel
hard wood handle

Art.-No.	Breite (mm) Width (mm)		
7830063	6	100	6
7830083	8	100	6
7830103	10	100	6
7830123	12	120	6
7830143	14	120	6
7830153	15	140	6
7830163	16	140	6
7830183	18	154	6
7830193	19	150	6
7830203	20	155	6
7830223	22	164	6
7830243	24	200	6
7930253	25	205	6
7830263	26	210	6
7830283	28	240	6
7830303	30	245	6
7830353	35	250	6



783 K

STECHBEITEL-SATZ, DIN 5139 FIRMER CHISEL SET, DIN 5139

ISO 2729
Chrom-Vanadium Stahl
Hartholzheft
im Karton

ISO 2729
Chrome-Vanadium steel
hard wood handle
in cardboard box

Art.-No.	No.	Breite (mm) Width (mm)		
7830013	783K/4	10 16 20 26	748	1
7830023	783K/6	6 10 12 16 20 26	780	1



784

HOHLBEITEL, DIN 5142 FIRMER GOUGE, DIN 5142

ISO 2729
Chrom-Vanadium Stahl
Hartholzheft

ISO 2729
Chrome-Vanadium steel
hard wood handle

Art.-No.	Breite (mm) Width (mm)		
7840063	6	100	6
7840083	8	100	6
7840103	10	100	6
7840123	12	140	6
7840133	13	140	6
7840163	16	160	6
7840203	20	160	6
7840263	26	200	6



785

DRECHSLERBEITEL, DIN 5144 TURNING TOOL, DIN 5144

ISO 2729
Chrom-Vanadium Stahl
Hartholzheft

ISO 2729
Chrome-Vanadium steel
hard wood handle

Art.-No.	No.		
7850013	Nr. 1: beidseitig angeschrägt No. 1: tapered (parting tool)	160	6
7850023	Nr. 2: abgerundet No. 2: round	160	6
7850033	Nr. 3: spitz No. 3: pointed	120	6
7850043	Nr. 4: schräg No. 4: oblique	140	6
7850053	Nr. 5: hohl No. 5: gouge	120	6



725

METALLSÄGEBOGEN, DIN 6473 A HACKSAW, DIN 6473 A

Hartholzheft
mit HSS-Sägeblatt Nr. 726

hard wood handle
with HSS saw blade No. 726

Art.-No.	l-mm-l		
7255300	530	754	1



781

FLACHSCHABER, DIN 8350 A FLAT SCRAPER, DIN 8350 A

legierter Werkzeugstahl | lackiert
Hartholzheft

Carbon alloy steel | lacquered
hard wood handle

Art.-No.	l-mm-l			
78115000	150	20 x 5	180	10
78120000	200	20 x 5	210	10
78125000	250	25 x 6	345	5
78130000	300	25 x 6	360	5



726

HSS-SÄGEBLATT, DIN 6494 A HSS SAW BLADE, DIN 6494 A

für Metallsägebogen Nr. 725

for Hacksaw No. 725

Art.-No.	l-mm-l		
7263000	300	17	10



780

DREIKANTHOHLSCHABER, DIN 8350 C TRIANGULAR HOLLOW SHAPE SCRAPER, DIN 8350 C

legierter Werkzeugstahl | lackiert
Hartholzheft

Carbon alloy steel | lacquered
hard wood handle

Art.-No.	l-mm-l			
7801500	150	14	96	10
7802000	200	16	140	10
7802500	250	16	210	10



727

METALLSÄGEBOGEN HACKSAW

glasfaserverstärkter Kunststoffgriff
mit Sägeblatt 150 mm

fibre glass reinforced plastic handle
with saw blade 150 mm

Art.-No.	l-mm-l		
7272500	250	169	5



782

LÖFFELSCHABER, DIN 8351 SPOON SCRAPER, DIN 8351

legierter Werkzeugstahl | lackiert
Hartholzheft

Carbon alloy steel | lacquered
hard wood handle

Art.-No.	l-mm-l			
7822000	200	8	178	5
7822500	250	8	211	5



385

UNIVERSAL-HEBELEISEN UNIVERSAL PRYBAR

Spezial-Werkzeugstahl
gehärtet, schwarz

Special Carbon steel
hardened, black

Art.-No.	l-mm-l		
3853800	380	685	1



786

NAGELEISEN, 6-KANT NAIL PULLER, 6-POINT

Spezial-Werkzeugstahl
durchgängig gehärtet, lackiert

Special Carbon steel
continuous hardened, lacquered

Art.-No.	l-mm-l	mm		
7864000	400	18	1100	1
7866000	600	18	1500	1
7868000	800	18	1900	1
7869000	900	18	2100	1
7861000	1000	18	2400	1

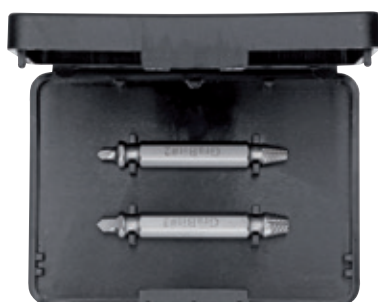

AUSDREHER
REMOVER

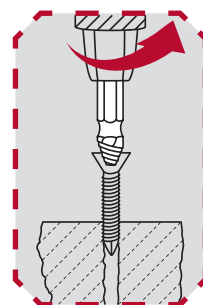

549

SCHRAUBEN- UND BOLZENAUSDREHER-SET FÜR BESCHÄDIGTE SCHRAUBEN

SCREW AND BOLT REMOVER SET
FOR DAMAGED SCREWS

Spezial-Werkzeugstahl
verchromt
in Kunststoffbox

Special Carbon steel
chrome plated
in plastic box

Ausdreher für Schrauben 3 – 6 mm

Remover for screws 3 – 6 mm

Ausdreher für Schrauben 5 – 10 mm

Remover for screws 5 – 10 mm

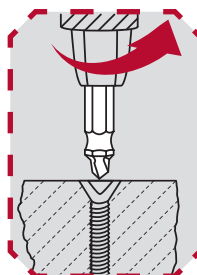

FRÄSER
MILLING CUTTER

Art.-No.	No.	H x B x T (mm) H x W x L (mm)		
5490000	549/2	10 x 80 x 50	97	10

549 TD

DISPLAY SCHRAUBEN- UND BOLZENAUSDREHER-SET FÜR BESCHÄDIGTE SCHRAUBEN

DISPLAY SCREW AND BOLT REMOVER
FOR DAMAGED SCREWS

Spezial-Werkzeugstahl
verchromt
in Kunststoffbox
10 Sets in Thekendisplay

Special Carbon steel
chrome plated
in plastic box
10 sets in sales counter display

Ausdreher für Schrauben 3 – 6 mm

Remover for screws 3 – 6 mm

Ausdreher für Schrauben 5 – 10 mm

Remover for screws 5 – 10 mm



Art.-No.	No.	H x B x T (mm) H x W x L (mm)		
5490010	549TD/10	430 x 155 x 185	970	1



803

UNIVERSAL-ABBRECHKLINGEN-MESSER UNIVERSAL SNAP OFF BLADE KNIFE

für Rechtshänder
mit Befestigungsöse
Klingenführung aus Metall
Gehäuse aus Kunststoff

for right handed use
with reinforcement eyelet
blade guide out of metal
housing made from plastic

Art.-No.	Klinge (mm) Blade (mm)	Klingenstärke (mm) Blade thickness (mm)	l-mm-l	g	Box
9299960	9 x 85	0,4	137	23	10



804

KOMFORT-ABBRECHKLINGEN-MESSER COMFORT SNAP OFF BLADE KNIFE

für Rechtshänder
mit Befestigungsöse
Klingenführung aus Metall
Messerarretierung mittels
Drehmechanismus
Gehäuse aus Metall
2-Komponentengriff

for right handed use
with reinforcement eyelet
blade guide out of metal
knife adjustment using the
rotary mechanism
housing made from metal
two component handle

Art.-No.	Klinge (mm) Blade (mm)	Klingenstärke (mm) Blade thickness (mm)	l-mm-l	g	Box
9299950	17,9 x 109,4	0,5	170	200	10

815

ABBRECHKLINGE SNAP OFF BLADE

C-Stahl | 10 Stück in Box



high Carbon steel | 10 pcs. in box

Art.-No.	Für For	Klinge (mm) Blade (mm)	Klingenstärke (mm) Blade thickness (mm)	l-mm-l	g	Box
9301720	No. 804	17,9 x 109,4	0,5	110	10	1



803 TD

DISPLAY UNIVERSAL-ABBRECHKLINGEN-MESSER DISPLAY UNIVERSAL SNAP OFF BLADE KNIFE

für Rechtshänder
mit Befestigungsöse
Klingenführung aus Metall
Gehäuse aus Kunststoff
36 Messer

for right handed use
with reinforcement eyelet
blade guide out of metal
housing made from plastic
36 knives

Art.-No.	L x B x H (mm) L x W x H (mm)	g	Box
9011490	190 x 140 x 150	991	1



804 TD

DISPLAY KOMFORT-ABBRECHKLINGEN-MESSER DISPLAY COMFORT SNAP OFF BLADE KNIFE

für Rechtshänder
mit Befestigungsöse
Klingenführung aus Metall
Messerarretierung mittels
Drehmechanismus
Gehäuse aus Metall
2-Komponentengriff
12 Messer

for right handed use
with reinforcement eyelet
blade guide out of metal
knife adjustment using the
rotary mechanism
housing made from metal
two component handle
12 knives

Art.-No.	L x B x H (mm) L x W x H (mm)	g	Box
9011500	210 x 165 x 225	1956	1



ERSATZKLINGEN-MAGAZIN
REPLACEMENT BLADE MAGAZINE



SICHERHEITSKLINGE
SAFETY BLADE



805

PROFI-SICHERHEITS-MESSER PROFI SAFETY KNIFE

für Rechtshänder
mit Befestigungsöse
Klingenführung aus Metall
mit automatischem Klingentrückzug
Klingenarretierung möglich
mit integriertem Folien- und
Papierschneider
mit Wechselklingen im Heft
Gehäuse aus Metall
Mehrkomponentengriff

for right handed use
with reinforcement eyelet
blade guide out of metal
with automatic blade retraction
blade lock possible
with integrated foil and
paper cutter
with reversing blades in the handle
housing made from metal
multicomponent handle

Art.-No.	Klinge (mm) Blade (mm)	Klingenstärke (mm) Blade thickness (mm)	l-mm-l	g	box
9299970	61 x 18,7	0,65	170	211	10

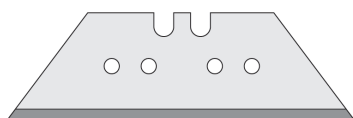

813

TRAPEZKLINGE TRIMMING KNIFE BLADE

C-Stahl
TIN-beschichtet
gehärtet
10 Stück im Spender

high Carbon steel
TIN-coated
hardened
10 pcs. in dispenser

Art.-No.	Für For	Klinge (mm) Blade (mm)	Klingenstärke (mm) Blade thickness (mm)	g	box
9298180	No. 805	61 x 18,7	0,65	20	1

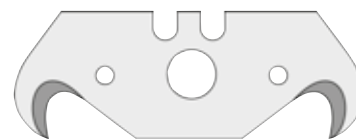

814

HAKENKLINGE HOOK BLADE

C-Stahl
TIN-beschichtet
gehärtet
10 Stück im Spender

high Carbon steel
TIN-coated
hardened
10 pcs. in dispenser

Art.-No.	Für For	Klinge (mm) Blade (mm)	Klingenstärke (mm) Blade thickness (mm)	g	box
9298190	No. 805	48,2 x 18,7	0,65	20	1



VDE WERKZEUGE
VDE TOOLS

09



1000 V AC

IEC 60900   

DIN EN 60090

VDE 0682 | 201

ARBEITEN AN SPANNUNG

In Deutschland sowie den meisten anderen Ländern ist vorgeschrieben, dass Arbeiten an spannungsführenden Teilen nur unter bestimmten Sicherheitsbedingungen und von ausgebildeten Fachleuten vorgenommen werden dürfen.

Dazu gehört zwingend der Einsatz von speziell hierfür hergestellten Werkzeugen.

Diese müssen der internationalen Norm IEC 60900 entsprechen (identisch mit EN 60900 für Europa und DIN EN 60900 für Deutschland).

WORK ON OR AROUND LIVE CIRCUITS

In Germany and most other countries, working on or around live circuits is allowed to be done only by professional electricians under standardized conditions.

Definitely required is the use of suitable, insulated tools.

These have to comply worldwide with the standard IEC 60900, which is identical with EN 60900 for Europe and DIN EN 60900 for Germany.

ISOLIERTE VDE-WERKZEUGE

Alle unsere isolierten Werkzeuge tragen das VDE-Prüfzeichen zusätzlich zum Prüfzeichen DIN EN 60900.

Dies bedeutet im Vergleich mit der DIN EN 60900 zusätzliche Sicherheit:

Jede Produktions- und Prüfstelle wird individuell von der VDE begutachtet, zertifiziert und regelmäßig überwacht.

Jede Ausführung eines isolierten Werkzeugs wird vom unabhängigen VDE-Prüfinstitut auf Herz und Nieren in Bezug auf mechanische und elektrische Sicherheit geprüft, bevor eine Typgenehmigung erteilt wird.

Das VDE-Prüfinstitut entnimmt in unregelmäßigen Abständen Prüfmuster aus der laufenden Produktion oder dem aktuellen Lager für intensive Stichprobentests.

INSULATED VDE TOOLS

Each of our insulated tools carries the logo „VDE“ in addition to the EN 60900 marking.

This guarantees optimized safety in addition to DIN EN 60900:

Each individual production and testing facility for insulated tools is being examined, certified and finally monitored regularly by the VDE institute.

Each individual pattern of an insulated tool is being tested thoroughly by the independent VDE test laboratories in line with the very stringent standards for electrical and mechanical safety before a type certificate is issued.

The VDE institute takes test samples out of the actual production or warehouse in irregular intervals for spot inspection as per the VDE specification.

PRÜFVERFAHREN WÄHREND DER PRODUKTION

Die von den Normen festgelegten Prüfverfahren während der laufenden Produktion sind vielschichtig und stellen sicher, dass die Vorgaben der DIN EN 60900 ohne Ausnahmen eingehalten werden. Nur so lässt sich sicher stellen, dass Isolationsstärken eingehalten werden, Werkzeuggriffe sich nicht bei Gebrauch lösen und durch Hitze- oder Kälteeinwirkung Schaden nehmen können.

So werden in genau festgelegten Intervallen verschiedenste Prüfungen am Produkt durchgeführt, die weit über die Grundanforderungen der üblichen Normen für nicht isolierte Werkzeuge hinaus gehen. Dies sind u. a. Schlag- und Stoßtests, Tests auf Hitze- und Kältebeständigkeit, Abzugstests, Flammtests etc..

Am Ende des Produktionsprozesses wird jedes einzelne Werkzeug einer Prüfung unter einer Wechselspannung von 10.000 VAC unterworfen. Erst nach Bestehen dieser 100%igen Stückprüfung darf das Werkzeug an Wechselspannungen von 1.000 VAC (Gleichstrom 1.500 VDC) eingesetzt werden.

**10-FACHE SICHERHEIT!
ERST DANN SIND WIR ZUFRIEDEN.**

DER BEWEIS: DAS VDE-LOGO

Das VDE-Zeichen beweist, dass der Hersteller über die durch die DIN EN 60900 bedingte Eigenverantwortung hinaus geht und sich und seine Produkte zusätzlich durch die unabhängigen Fachleute des VDE-Institutes überwachen lässt.



TEST PROCEDURES DURING PRODUCTION

The stringent DIN EN 60900 standard ensures that during daily production all standard requirements are being strictly observed. That is the only way to ensure correct thickness of insulation layers, safe fit of insulated handles on the tool and prevention of damages due to heat or coldness.

Different product tests in exactly defined intervals on top of any requirement on non-insulated tools ensure a state-of-the-art level of electrical safety. This includes shatter and stroke tests, test on resistance against high and low temperatures, adhesion tests, flame tests etc.

Finally – at the end of the production run – each individual insulated tool has to withstand a test voltage of 10.000 VAC. Only when this procedure has been passed successfully, the tool is allowed to be used on alive circuit of 1.000 VAC (1.500 VDC).

**SAFETY FACTOR 10!
IT'S NOT EASY TO SATISFY OURSELVES.**

THE PROOF: THE VDE LOGO

The VDE logo proves, that the proofs that the manufacturer not only works under own responsibility to DIN EN 60900, but adds additional user trust into his products by letting his tools and production facilities getting monitored by independent experts of the VDE institute.





884



VDE KOMBINATIONSZANGE, DIN ISO 5746
VDE COMBINATION PLIERS, DIN ISO 5746

isoliert nach DIN EN 60900
(VDE 0682/201)
Chrom-Vanadium Stahl
verchromt
Kopf hochglanzpoliert
2-Komponentengriffe

insulated according to DIN EN 60900
(VDE 0682/201)
Chrome-Vanadium steel
chrome plated
head mirror polished
two component handle

Art.-No.	l-mm-l		
9269538	180	279	6
9269548	200	342	6



885



VDE SEITENSCHNEIDER, DIN ISO 5749
VDE DIAGONAL CUTTERS, DIN ISO 5749

isoliert nach DIN EN 60900
(VDE 0682/201)
Chrom-Vanadium Stahl
verchromt
Kopf hochglanzpoliert
2-Komponentengriffe

insulated according to DIN EN 60900
(VDE 0682/201)
Chrome-Vanadium steel
chrome plated
head mirror polished
two component handle

Art.-No.	l-mm-l		
9272208	145	185	6
9269558	160	212	6



886



VDE KRAFTSEITENSCHNEIDER, DIN ISO 5749
VDE HEAVY DUTY DIAGONAL CUTTERS, DIN ISO 5749

isoliert nach DIN EN 60900
(VDE 0682/201)
Chrom-Vanadium Stahl
verchromt
Kopf hochglanzpoliert
2-Komponentengriffe

insulated according to DIN EN 60900
(VDE 0682/201)
Chrome-Vanadium steel
chrome plated
head mirror polished
two component handle

Art.-No.	l-mm-l		
9269568	165	218	6
9269578	180	224	6
9272218	200	296	6



887



VDE FLACHRUNDZANGE, DIN ISO 5745
VDE SNIPE NOSE PLIERS, DIN ISO 5745

isoliert nach DIN EN 60900
(VDE 0682/201)
Chrom-Vanadium Stahl
verchromt
Kopf hochglanzpoliert
2-Komponentengriffe
gerade Ausführung

insulated according to DIN EN 60900
(VDE 0682/201)
Chrome-Vanadium steel
chrome plated
head mirror polished
two component handle
straight pattern

Art.-No.	l-mm-l		
9272228	170	150	6
9272238	200	201	6



888



VDE FLACHRUNDZANGE, DIN ISO 5745
VDE SNIPE NOSE PLIERS, DIN ISO 5745

isoliert nach DIN EN 60900
(VDE 0682/201)
Chrom-Vanadium Stahl
verchromt
Kopf hochglanzpoliert
2-Komponentengriffe
45° abgewinkelte Ausführung

insulated according to DIN EN 60900
(VDE 0682/201)
Chrome-Vanadium steel
chrome plated
head mirror polished
two component handle
45° bent pattern

Art.-No.	l-mm-l		
9272248	160	154	6
9272258	200	204	6

889



VDE ABISOLIERZANGE
VDE WIRE STRIPPER

isoliert nach DIN EN 60900
(VDE 0682/201)
Chrom-Vanadium Stahl
verchromt
Kopf hochglanzpoliert
2-Komponentengriffe
mit Messing-Einstellschraube
und Feder

insulated according to DIN EN 60900
(VDE 0682/201)
Chrome-Vanadium steel
chrome plated
head mirror polished
two component handle
with brass adjustment screw
and spring

Art.-No.	l-mm-l		
9269588	160	166	6



591



VDE WERKSTATT-SCHRAUBENDREHER, DIN ISO 2380
VDE ENGINEERS SCREWDRIVER, DIN ISO 2380

für Schlitzschrauben	for slotted screws
S2-Profi-Stahl	S2 Professional steel
isoliert nach DIN EN 60900	insulated according to DIN EN 60900
(VDE 0682/201)	(VDE 0682/201)
2-Komponentenheft	two component handle
Klinge mit magnetischer Spitze	blade with magnetic tip

Art.-No.	mm	mm	mm	l-mm-l	g	
5910000	2,5	75	1,2	160	30	10
5910010	4,0	100	1,2	185	40	10
5910020	5,5	125	1,2	230	70	10
5910030	6,5	150	1,0	260	110	10



594 S



VDE SCHRAUBENDREHER-GARNITUR, DIN ISO 2380, DIN ISO 8764
VDE SCREWDRIVER SET, DIN ISO 2380, DIN ISO 8764

S2-Profi-Stahl	S2 Professional steel
isoliert nach DIN EN 60900	insulated according to DIN EN 60900
(VDE 0682/201)	(VDE 0682/201)
2-Komponentenheft	two component handle
Klinge mit magnetischer Spitze	blade with magnetic tip
9-tlg.	9 pcs.
im Sichtkarton	in display cardboard box

Inhalt Content	Klinge Blade	mm	mm
591		2,5	75
591		4,0	100
591		6,5	150
593		PH0	60
593		PH1	80
593		PH2	100
593		PH3	150
Spannungsprüfer Voltage tester		3,0	65

Art.-No.	H x B x T (mm) H x W x L (mm)	g	
5940000	300 x 195 x 40	750	1



593



VDE PH SCHRAUBENDREHER, DIN ISO 8764
VDE PH SCREWDRIVER, DIN ISO 8764

für PH-Kreuzschlitzschrauben	for PH screws
S2-Profi-Stahl	S2 Professional steel
isoliert nach DIN EN 60900	insulated according to DIN EN 60900
(VDE 0682/201)	(VDE 0682/201)
2-Komponentenheft	two component handle
Klinge mit magnetischer Spitze	blade with magnetic tip

Art.-No.		mm	l-mm-l	g	
5930000	PH0	60	145	30	10
5930010	PH1	80	170	60	10
5930020	PH2	100	205	90	10
5930030	PH3	150	260	150	10



556 TD



THEKENDISPLAY SCHRAUBENDREHER-GARNITUREN
DISPLAY SCREWDRIVER SETS

12-tlg.	12 pcs.
6 Schraubendreher-Garnituren	6 Screwdriver Sets
6 VDE Schraubendreher-Garnituren	6 VDE Screwdriver Sets

Art.-No.	H x B x T (mm) H x W x L (mm)	g	
5560003	320 x 500 x 370	13500	1



1769



VDE EINMAULSCHLÜSSEL, DIN 7446
VDE SINGLE OPEN ENDED SPANNER, DIN 7446

Chrom-Vanadium Stahl
verchromt
2-farbige Doppelisolation
gelb-rot

Chrome-Vanadium steel
chrome plated
two-colour double insulation
yellow-red

Art.-No.	mm				
17690100	10	•	•	36	10
17690110	11	•	•	48	10
17690120	12	•	•	58	10
17690130	13	•	•	60	10
17690140	14	•	•	68	10
17690150	15	•	•	88	10
17690160	16	•	•	148	10
17690170	17	•	•	110	10
17690180	18	•	•	145	10
17690190	19	•	•	160	5
17690210	21	•	•	200	5
17690220	22	•	•	180	5
17690240	24	•	•	285	5
17690270	27	•	•	300	5
17690300	30	•	•	430	5
17690320	32	•	•	450	5

1729



VDE EINRINGSCHLÜSSEL, DIN 7447
VDE SINGLE ENDED RING SPANNER, DIN 7447

Chrom-Vanadium Stahl
verchromt
2-farbige Doppelisolation
gelb-rot

Chrome-Vanadium steel
chrome plated
two-colour double insulation
yellow-red

Art.-No.	mm				
17290100	10	•	•	82	10
17290110	11	•	•	84	10
17290120	12	•	•	84	10
17290130	13	•	•	85	10
17290140	14	•	•	85	10
17290150	15	•	•	154	10
17290160	16	•	•	156	10
17290170	17	•	•	156	10
17290180	18	•	•	160	10
17290190	19	•	•	236	5
17290210	21	•	•	202	5
17290220	22	•	•	204	5
17290240	24	•	•	350	5
17290270	27	•	•	390	5
17290300	30	•	•	470	5
17290320	32	•	•	490	5

1760



VDE SECHSKANT-STIFTSCHLÜSSEL MIT QUERGRIFF
VDE T-HANDLE HEXAGON KEY WRENCH

Chrom-Vanadium Stahl
vernickelt
2-farbige Doppelisolation gelb-rot

Chrome-Vanadium steel
nickel plated
two-colour double insulation yellow-red

Art.-No.	mm			
9288716	4	•	•	1
9288726	5	•	•	1
9288736	6	•	•	1
9288746	8	•	•	1

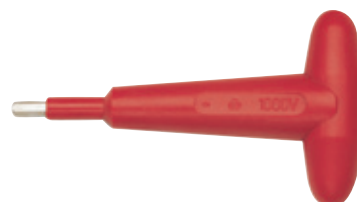



1736

1000VAC 12,5 1/2"

VDE STECKSCHLÜSSEL-EINSATZ, 6-KANT, DIN 7448
VDE SOCKET, 6-POINT, DIN 7448

Chrom-Vanadium Stahl
verchromt
2-farbige Doppelisolation
gelb-rot

Chrome-Vanadium steel
chrome plated
two-colour double insulation
yellow-red

Art.-No.	mm				
17360100	10	•	•	62	10
17360110	11	•	•	60	10
17360120	12	•	•	60	10
17360130	13	•	•	60	10
17360140	14	•	•	60	10
17360150	15	•	•	70	10
17360170	17	•	•	60	10
17360190	19	•	•	88	10
17360220	22	•	•	110	10
17360240	24	•	•	140	10
17360270	27	•	•	175	10
17360300	30	•	•	195	10
17360320	32	•	•	195	10

1737

1000VAC 12,5 1/2"

VDE STECKSCHLÜSSEL-EINSATZ FÜR INNENSECHSKANT-SCHRAUBEN, DIN 7448
VDE SOCKET FOR INSIDE HEXAGON SCREWS, DIN 7448

Chrom-Vanadium Stahl
verchromt
2-farbige Doppelisolation
gelb-rot

Chrome-Vanadium steel
chrome plated
two-colour double insulation
yellow-red

Art.-No.	mm				
17370460	4	•	•	86	10
17370560	5	•	•	88	10
17370660	6	•	•	90	10
17370860	8	•	•	94	10
17371060	10	•	•	98	10



1731

1000VAC 12,5 1/2"

VDE HEBELUMSCHALTKNARRE, DIN 7449
VDE REVERSIBLE RATCHET, DIN 7449

Chrom-Vanadium Stahl
verchromt
2-farbige Doppelisolation
gelb-rot
Lösen oder Festhalten des
Einsatzes durch Knopfdruck

Chrome-Vanadium steel
chrome plated
two-colour double insulation
yellow-red
holding or locking the
socket by pressing the button

Art.-No.	l-mm-l				
17310120	260	•	•	666	1

1791

1000VAC 12,5 1/2"

VDE DREHMOMENTSCHLÜSSEL, DIN 7449
VDE TORQUE WRENCH, DIN 7449

einstellbar
legierter, gehärteter Stahl
verchromt
2-farbige Doppelisolation gelb-rot
Genauigkeit +/- 4% des Messwertes
Drehmomentwert einstellbar durch
den Knopf am Ende des Griffes
das Erreichen des Drehmoments
fühlt man durch das Abknicken
des Kopfes

adjustable
special steel
chrome plated
two-colour double insulation yellow-red
accuracy +/- 4% from scale
Torque value adjustable by
the button at the end of the handle
Click-off function noticeable during
action

Art.-No.	Meßbereich (Nm) Capacity range (mm)	l-mm-l				
17910550	5-50	370	•	•	1100	1



1734

1000VAC 12,5 1/2"

VDE VERLÄNGERUNG, DIN 7434
VDE EXTENSION BAR, DIN 7434

Chrom-Vanadium Stahl
verchromt
2-farbige Doppelisolation
gelb-rot

Chrome-Vanadium steel
chrome plated
two-colour double insulation
yellow-red

Art.-No.	l-mm-l				
17341250	125	•	•	70	5
17352500	250	•	•	404	5



1748

1000VAC

VDE STECKSCHLÜSSEL MIT GRIF, DIN 7445
VDE NUTDRIVER WITH HANDLE, DIN 7445

Chrom-Vanadium Stahl | verchromt
2-farbige Doppelisolation
gelb-rot

Chrome-Vanadium steel | chrome plated
two-colour double insulation
yellow-red

Art.-No.	mm				
17480050	5	•	•	65	10
17480060	6	•	•	76	10
17480070	7	•	•	104	10
17480080	8	•	•	114	10
17480090	9	•	•	101	6
17480100	10	•	•	110	6
17480110	11	•	•	148	6
17480130	13	•	•	151	6



1771

1000VAC

VDE SÄGEBOGEN
VDE HACKSAW

mit auswechselbarem 300 mm
Sägeblatt
2-farbige Doppelisolation
gelb-rot

with exchangeable 300 mm
saw blade
two-colour double insulation
yellow-red

Art.-No.				
17713000	•	•	70	1



1772

1000VAC

VDE SÄGEBOGEN
VDE HACKSAW

mit auswechselbarem 150 mm
Sägeblatt
2-farbige Doppelisolation
gelb-rot

with exchangeable 150 mm
saw blade
two-colour double insulation
yellow-red

Art.-No.				
17721500	•	•	70	1



1761

VDE KABELMESSER
VDE CABLE KNIFE

1000VAC

rostfreier Stahl
verchromt
gerade Klinge
schlagfester Kunststoffgriff

rustless steel
chrome plated
straight blade
shatterproof plastic handle

Art.-No.				
17611800	•	•	70	5



1762

VDE KABELMESSER
VDE CABLE KNIFE

1000VAC

rostfreier Stahl
verchromt
Hakenklinge
schlagfester Kunststoffgriff

rustless steel
chrome plated
hook blade
shatterproof plastic handle

Art.-No.				
17621800	•	•	70	5



1763

VDE ABMANTELMESSER
VDE DISMANTLING KNIFE

1000VAC

rostfreier Stahl
verchromt
Hakenklinge mit Schutzplatte an der Spitze zum Schutz der Leiterisolation
schlagfester Kunststoffgriff

rustless steel
chrome plated
hook blade with protection guide to protect wire insulation
shatterproof plastic handle

Art.-No.				
17631800	•	•	70	5



1784

VDE KOMBINATIONSZANGE, DIN ISO 5746
VDE COMBINATION PLIERS, DIN ISO 5746

1000VAC

Chrom-Vanadium Stahl
verchromt
2-farbige Doppelisolation
gelb-rot

Chrome-Vanadium steel
chrome plated
two-colour double insulation
yellow-red

Art.-No.	l-mm-l				
17841650	165	•	•	230	6
17841900	190	•	•	390	6
17842100	210	•	•	390	6



1787

VDE SEITENSCHNEIDER, DIN ISO 5749
VDE DIAGONAL CUTTERS, DIN ISO 5749

1000VAC

Chrom-Vanadium Stahl
verchromt
2-farbige Doppelisolation gelb-rot

Chrome-Vanadium steel
chrome plated
two-colour double insulation yellow-red

Art.-No.	l-mm-l				
17871600	160	•	•	210	6
17871800	180	•	•	223	6

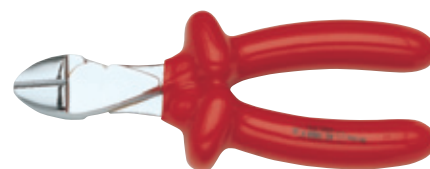

1786

VDE KRAFTSEITENSCHNEIDER, DIN ISO 5749
VDE HEAVY DUTY DIAGONAL CUTTERS, DIN ISO 5749

1000VAC

Chrom-Vanadium Stahl
verchromt
2-farbige Doppelisolation gelb-rot

Chrome-Vanadium steel
chrome plated
two-colour double insulation yellow-red

Art.-No.	l-mm-l				
17861700	170	•	•	275	6
17862000	200	•	•	380	6

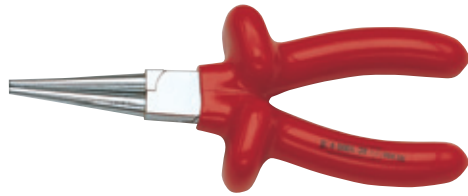

1781

1000VAC

VDE LANGBECK-RUNDZANGE, DIN ISO 5745
VDE LONG ROUND NOSE PLIERS, DIN ISO 5745

Chrom-Vanadium Stahl verchromt
2-farbige Doppelisolation gelb-rot

Chrome-Vanadium steel chrome plated
two-colour double insulation yellow-red

Art.-No.	l-mm-l				
17811600	160	•	•	238	6



1788

1000VAC

VDE ABISOLIERZANGE
VDE WIRE STRIPPING PLIERS

Chrom-Vanadium Stahl verchromt
2-farbige Doppelisolation gelb-rot

Chrome-Vanadium steel chrome plated
two-colour double insulation yellow-red

Art.-No.	l-mm-l				
17881600	160	•	•	200	6



1790

1000VAC

VDE FLACHRUNDZANGE, DIN ISO 5745
VDE SNIPE NOSE PLIERS, DIN ISO 5745

45° gebogene Backen, mit Schneide
Chrom-Vanadium Stahl verchromt
2-farbige Doppelisolation gelb-rot

45° bent jaws, with cutter
Chrome-Vanadium steel chrome plated
two-colour double insulation yellow-red

Art.-No.	l-mm-l				
1790160	160	•	•	170	6
1790200	200	•	•	250	6

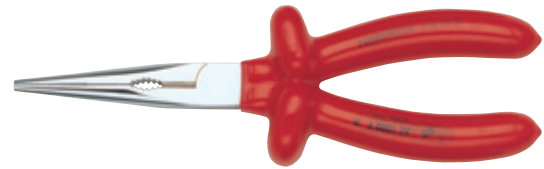

1789

1000VAC

VDE FLACHRUNDZANGE, DIN ISO 5745
VDE SNIPE NOSE PLIERS, DIN ISO 5745

gerade Backen, mit Schneide
Chrom-Vanadium Stahl verchromt
2-farbige Doppelisolation gelb-rot

straight jaws, with cutter
Chrome-Vanadium steel chrome plated
two-colour double insulation yellow-red

Art.-No.	l-mm-l				
17891600	160	•	•	130	6
17892000	200	•	•	240	6

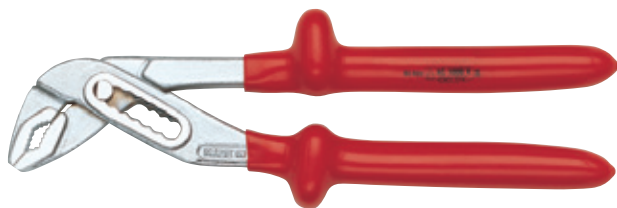

1780

1000VAC

VDE WASSERPUMPENZANGE, DIN ISO 8976
VDE WATER PUMP PLIERS, DIN ISO 8976

Chrom-Vanadium Stahl verchromt
2-farbige Doppelisolation gelb-rot

Chrome-Vanadium steel chrome plated
two-colour double insulation yellow-red

Art.-No.	l-mm-l				
17802400	250	•	•	450	6



1700

VDE WERKZEUGSATZ VDE TOOL SET

VDE Kabelmesser 180 mm
 VDE Sechskant-Stiftschlüssel mit Quergriff 5 mm
 VDE Abisolierzange 160 mm
 VDE Seitenschneider 160 mm
 VDE Kombinationszange 190 mm
 VDE Flachrundzange, gerade 200 mm
 VDE Schraubendreher 4 x 100 | 5,5 x 125 | 6,5 x 150
 VDE PH Schraubendreher PH0 | PH1
 VDE Spannungsprüfer 3,0 x 65
 isoliert nach DIN EN 60900 (VDE 0682/201)
 12-tlg.



VDE Cable Knife 180 mm
 VDE Inside Hexagon T-Handle Screwdriver 5 mm
 VDE Wire Stripping Pliers 160 mm
 VDE Diagonal Cutters 160 mm
 VDE Combination Pliers 190 mm
 VDE Snipe Nose Pliers, straight 200 mm
 VDE Screwdriver 4 x 100 | 5,5 x 125 | 6,5 x 150
 VDE PH Screwdriver PH0 | PH1
 VDE Voltage Tester 3,0 x 65
 insulated according to DIN EN 60900 (VDE 0682/201)
 12 pcs.

Art.-No.	H x B x T (mm) H x W x L (mm)	 VDE 0682/201	 DIN EN 60900 IEC 60980	 g	
17000000	106 x 450 x 360	.	.	1810	1



**FUNKENFREIES
WERKZEUG**
NON-SPARKING TOOLS

10

FUNKENFREIE WGB-WERKZEUGE

TECHNISCHE INFORMATIONEN:

Funkenfreie WGB-Werkzeuge eignen sich für besonders anspruchsvolle Einsatzgebiete, bei denen Funken eine potentielle Feuer- und Explosionsgefahr darstellen. Sie sind antimagnetisch und zeichnen sich durch eine extrem hohe Korrosionsbeständigkeit gegenüber den verschiedensten Medien aus. Sie werden aus hochverschleißbeständigen Nicht-Eisen-Legierungen hergestellt (Sonderbronze, Kupfer-Beryllium) und vom Berliner Bundesamt für Materialforschung und Prüfung offiziell geprüft.

Funkenfreie WGB-Werkzeuge werden weltweit in folgenden Bereichen eingesetzt:

- Öl- und Gasförderung
- Petrochemie
- Chemische Industrie
- Pipeline-Bau
- Militär
- Zivil- und Katastrophenschutz
- Gas- und Elektrizitätswerke
- Tankreiniger
- Lackierereien

und in allen anderen Situationen, in denen Funken eine potenzielle Brand- und Explosionsgefahr darstellen können.

QUALITÄTSPRÜFUNG

Zur Gewährleistung der höchsten Qualitätsansprüche unserer funkenfreien Werkzeuge wird von jeder Charge eine Prüfung nach DIN 50049.2.2 vorgenommen.

Geprüft werden:

- Mechanische Eigenschaften
(Streckgrenze, Zugfestigkeit, Dehnung, Härte)
- Chemische Zusammensetzung

Durch diese Qualitätskontrolle wird sichergestellt, dass unsere funkenfreien Werkzeuge jederzeit die höchsten Qualitätsanforderungen erfüllen.

MATERIALANALYSE FUNKENFREIER WERKSTOFFE

Material	Sonderbronze SB (Aluminium-Mehrstoff Bronze)					Kupfer-Beryllium			
	Cu	Al	Ni	Fe	Mn	Be	Ni	Co	Cu
Analyse	Rest	9	2	1	-	1,8	0,1	0,1	Rest
min. in %	Rest	12	5	3	1,5	2,0	0,6	0,6	Rest
max. in %									
Mechanische Eigenschaften									
Festigkeit N/mm ²	750 - 850					1140 - 1310			
Streckgrenze N/mm ²	450 - 550					840 - 860			
Härten Brinell	200 / 250					310 / 360			
Physikalische Eigenschaften									
Spezifisches Gewicht	8,45					8,26			
Magnetische Eigenschaft	1,3					1,0025			
Hitzeausdehnung 20-200 °C	0,000015 %					0,000012 %			
Elektrische Leitfähigkeit	8 / 12					8 / 6			

ZUSÄTZLICHE MATERIALPRÜFUNGEN

Auf Wunsch können wir eine zusätzliche, kostenpflichtige spezifische Prüfung eines jeden Werkzeugs durchführen:

- Erstellung eines Röntgenbildes zur Auffindung von Lunkern
- Überprüfung auf Oberflächenrisse

HERSTELLUNG UND QUALITÄTSÜBERWACHUNG

Fast alle unsere funkenfreien Werkzeuge werden nach Holz- oder Kunststoffmodellen abgegossen. Die Modelle werden von versierten und erfahrenen Modellbauern – entsprechend der DIN für Handwerkzeug – maßlich gefertigt.

ABGUSS

Nach dem Erstabguss wird eine umfassende Prüfung vorgenommen. Die Materialzusammensetzung und -erhitzung, die Sandformen und der Steiger müssen einen optimalen Abguss ergeben. Diese Daten werden festgehalten, so dass bei jedem wiederkehrenden Abguss zu gleichen Bedingungen die Idealwerte erreicht werden können. Dadurch wird eine hohe Qualitätssicherung erzielt.

ANWENDUNGSHINWEISE

Aufgrund ihrer Anwendungen müssen funkenfreie Werkzeuge weicher sein als herkömmliche Werkzeuge. Deshalb sollte der Einsatz dieser Werkzeuge mit besonderer Sorgfalt erfolgen. Überbeanspruchung ist zu vermeiden. Der Einsatz von funkenfreien Werkzeugen darf nicht die einzige Schutzmaßnahme in feuer- und explosionsgefährdeten Bereichen sein. Zum umfassenden Schutz von Personal und Einrichtung beachten Sie bitte die Vorschriften Ihrer Berufsgenossenschaft.

NACHBEARBEITUNG

Solltest du selbst eine Nachbearbeitung an den Werkzeugen vornehmen wollen (z. B. Nachschärfen), übersenden wir dir gerne unser technisches Merkblatt.

GARANTIE

Funkenfreie WGB-Werkzeuge beinhalten eine Garantie gegen Material- und Herstellungsfehler. Entstandene Schäden durch falsche Handhabung oder Nichtbeachtung der Anwendungshinweise werden jedoch von dieser Garantie nicht eingeschlossen. Änderungen in Material, Verarbeitung und Ausführung behalten wir uns vor.

NON-SPARKING WGB TOOLS

TECHNICAL INFORMATION

Non-Sparking WGB Tools are designed for use in very demanding areas, where sparks mean a possible risk of fire or explosions. Further they are antimagnetic and extremely corrosion-resistant against many media. They are produced out of a non-iron-alloy (special bronze, copper-beryllium), which are highly wear-resistant. Both alloys are checked through the Federal Office for material research and examination/Berlin.

Non-Sparking WGB Tools are used world-wide in the following fields:

- Oil- and gas industry
- Petrochemistry
- Chemical industry
- Pipeline industry
- Defence forces (army, navy, air force)
- Civil defence and disaster control
- Gasworks and power stations
- Tank refiner
- Paint spraying shops

and in all other situations, in which sparks can be a potential danger of fire and explosion.

QUALITY ASSURANCE

To ensure the highest quality standards of our non-sparking tools, every production run is tested according to DIN 50049.2.2.

We check:

- Mechanical properties
(Yield point, Tensile strength, Stretching, Grade of hardness)
- Chemical composition

Through this quality control is ensured that our non-sparking tools fulfil the highest quality demands every time.

ADDITIONAL MATERIAL CONTROLS

Upon request we can make an additional, chargeable specific check of each tool:

- X-ray control for finding blow-holes
- Checking for surface cracks

PRODUCTION AND QUALITY ASSURANCE

Nearly all our non-sparking tools are casted from moulds out of wood or synthetic material. The moulds are produced to precise specifications according to the DIN (German Industrial Standard) by experienced and highly qualified mould manufacturers.

CASTING

After the first casting, there is an extensive examination. The composition and the heating of the material, the sand moulds and the pipe have to come to an optimal casting. We record this data so that we are able to reach the ideal standard with the same conditions at every future casting. This quality assurance system ensures a high and equal quality standard.

INSTRUCTIONS FOR USE

Non-sparking tools have to be softer than conventional tools. For this reason the use of non-sparking tools has to be carried out with special care. Overstraining has to be avoided. The use of non-sparking tools must not be the only preventive measure in areas of fire and explosion risks. For an extensive protection of staff and equipment, please follow the instructions of your employers' liability insurance association.

FOLLOW-UP TREATMENT

If you want to make a follow-up treatment on the tools (e.g. re-sharpening) by yourself, we would be pleased to send you our technical instructions.

GUARANTEE

Non-Sparking WGB Tools carry a guarantee against mistakes in material and producing. However, this guarantee does not include damages caused by an improper handling. We reserve the right to any changes in material, workmanship and design without notice.

ANALYSIS OF NON-SPARKING MATERIAL

Material	Special bronze (Aluminium multi-alloy bronze)					Copper-beryllium			
	Cu	Al	Ni	Fe	Mn	Be	Ni	Co	Cu
Analysis	Rest	9	2	1	-	1.8	0.1	0.1	Rest
min. in %	Rest	12	5	3	1.5	2.0	0.6	0.6	Rest
max. in %									
Mechanical properties									
Strength N/mm ²	750 - 850					1140 - 1310			
Yield point N/mm ²	450 - 550					840 - 860			
Hardness Brinell	200 / 250					310 / 360			
Physical properties									
Specific weight	8,45					8,26			
Magnetic properties	1,3					1,0025			
Heat-extension 20-200 °C	0,000015 %					0,000012 %			
Electrical conductivity	8 / 12					8 / 6			



1869

DOPPELMAULSCHLÜSSEL, FUNKENFREI
DOUBLE OPEN ENDED SPANNER, SPARK FREE

Art.-No.	Ø mm	l-mm-l	g	📦
186906070	6 x 7	125	19	10
186908090	8 x 9	140	29	10
186910110	10 x 11	140	51	10
186912130	12 x 13	160	73	10
186914150	14 x 15	200	92	10
186916170	16 x 17	200	112	10
186916180	16 x 18	200	120	10
186917190	17 x 19	225	151	10
186918190	18 x 19	225	159	10
186920220	20 x 22	225	223	10
186921230	21 x 23	225	223	10
186924270	24 x 27	270	312	10
186925280	25 x 28	270	352	10
186930320	30 x 32	300	466	10
186936410	36 x 41	360	727	5



1829

DOPPELRINGSCHLÜSSEL, GEKRÖPFT, FUNKENFREI
DOUBLE ENDED RING SPANNER, OFFSET, SPARK FREE

Art.-No.	Ø mm	l-mm-l	g	📦
182906070	6 x 7	170	80	10
182908090	8 x 9	170	80	10
182910110	10 x 11	185	100	10
182912130	12 x 13	195	110	10
182914150	14 x 15	230	240	10
182916170	16 x 17	280	370	10
182918190	18 x 19	280	360	10
182919220	19 x 22	300	371	10
182920220	20 x 22	300	490	10
182921230	21 x 23	300	480	10
182924270	24 x 27	330	470	10
182930320	30 x 32	370	840	10

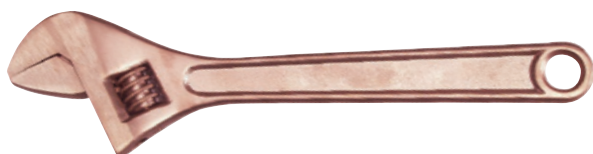

1862

ROLLGABELSCHLÜSSEL, FUNKENFREI
ADJUSTABLE WRENCH, SPARK FREE

Art.-No.	l-L-l	Ø mm	l-mm-l	g	📦
18622000	8"	max. 22	200	245	1
18622500	10"	max. 27	250	920	1
18623000	12"	max. 30	300	1320	1
18623800	15"	max. 44	380	1700	1



1827

SCHLAGRINGSCHLÜSSEL, FUNKENFREI
SLUGGING RING WRENCH, SPARK FREE

Art.-No.	Ø mm	l-mm-l	g	📦
18270170	17	165	250	5
18270190	19	165	250	5
18270220	22	165	410	5
18270240	24	165	320	5
18270270	27	180	320	5
18270300	30	190	360	5
18270320	32	190	572	1
18270360	36	205	708	1
18270410	41	230	1090	1
18270460	46	240	950	1
18270500	50	255	1446	1
18270550	55	270	1360	1
18270600	60	280	1600	1



1836

12,5 1/2"

STECKSCHLÜSSELEINSATZ, 6-KANT, FUNKENFREI
SOCKET, 6-POINT, SPARK FREE

Art.-No.	mm	l-mm-l	g	
18360100	10	40	120	10
18360110	11	40	120	10
18360120	12	40	120	10
18360130	13	40	130	10
18360140	14	40	130	10
18360150	15	40	130	10
18360160	16	40	130	10
18360170	17	40	140	10
18360180	18	40	140	10
18360190	19	40	140	10
18360200	20	40	180	10
18360210	21	40	180	10
18360220	22	40	180	10
18360230	23	40	180	10
18360240	24	40	180	10
18360270	27	45	200	10
18360300	30	45	320	10
18360320	32	47	320	10



1831

12,5 1/2"

KNARRE, UMSTECKBAR, FUNKENFREI
PUSH-THROUGH RATCHET, SPARK FREE

Art.-No.	l-mm-l	g	
18312500	750	650	1

1834

12,5 1/2"

VERLÄNGERUNG, FUNKENFREI
EXTENSION BAR, SPARK FREE

Art.-No.	l-mm-l	g	
18331250	125	200	1
18342500	250	400	1





1832

SECHSKANT-STIFTSCHLÜSSEL, FUNKENFREI
HEXAGON KEY WRENCH, SPARK FREE



Art.-No.	Ø mm	l-mm-l	g	📦
18320020	2	50 x 16	5	10
18320030	3	63 x 20	5	10
18320040	4	70 x 25	10	10
18320050	5	80 x 28	15	10
18320060	6	90 x 32	25	10
18320080	8	100 x 36	60	10
18320100	10	112 x 40	100	10
18320120	12	125 x 45	165	10
18320140	14	140 x 55	250	10
18320170	17	160 x 60	420	10
18320190	19	180 x 70	600	10
18320220	22	200 x 80	950	10



1886

KOMBINATIONSZANGE, FUNKENFREI
COMBINATION PLIERS, SPARK FREE

Art.-No.	l-mm-l	g	📦
18862000	200	330	6

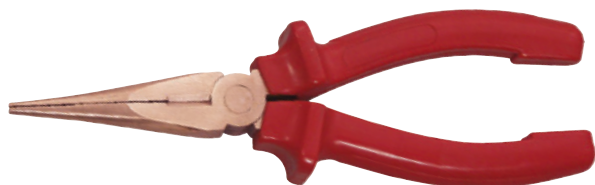

1885

FLACHRUNDZANGE, FUNKENFREI
SNIPE NOSE PLIERS, SPARK FREE

gerade Ausführung

straight pattern

Art.-No.	l-mm-l	g	📦
18851800	180	150	6



1884

SEITENSCHNEIDER, FUNKENFREI
DIAGONAL CUTTERS, SPARK FREE

Art.-No.	l-mm-l	g	📦
18841650	165	200	6



1882

RUNDZANGE, FUNKENFREI
ROUND NOSE PLIERS, SPARK FREE

Art.-No.	l-mm-l	g	📦
18821600	160	140	6

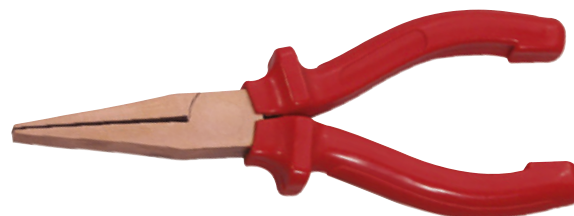

1883

FLACHZANGE, FUNKENFREI
FLAT NOSE PLIERS, SPARK FREE

Art.-No.	l-mm-l	g	📦
18831600	160	150	6

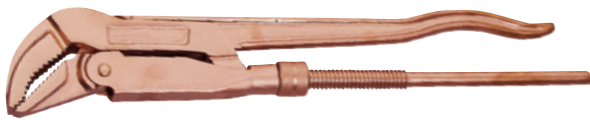

1888

ECKROHRZANGE, FUNKENFREI
PIPE WRENCH, SPARK FREE

45° abgewinkelt, gerades Maul

45° bent, straight jaw

Art.-No.	Maulweite Jaw opening mm/AF"	l-mm-l	g	☐
18881000	1"	320	900	1
18881500	1.1/2"	410	1600	1
18882250	2.1/4"	540	3000	1
18883000	3"	690	3800	1

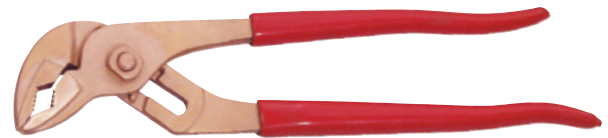

1800

WASSERPUMPENZANGE, FUNKENFREI
WATER PUMP PLIERS, SPARK FREE

Art.-No.	l-mm-l	g	☐
18002500	250	400	1

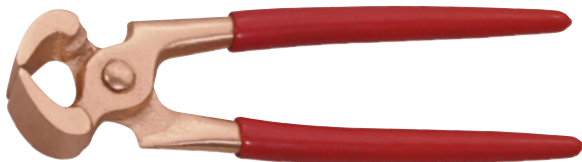

1881

KANTENZANGE, FUNKENFREI
CARPENTER'S PINCERS, SPARK FREE

Art.-No.	l-mm-l	g	☐
18812000	200	410	6
18812300	230	520	6



1853

WERKSTATT-SCHRAUBENDREHER, FUNKENFREI
ENGINEERS SCREWDRIVER, SPARK FREE

Art.-No.	mm	mm	g	☐
185345100	4,5	100	65	1
185345150	4,5	150	70	1
185360100	6	100	100	1
185360150	6	150	110	1
185380150	8	150	150	1
185310200	10	200	190	1
185310300	10	300	290	1



1854

PH SCHRAUBENDREHER, FUNKENFREI
PH SCREWDRIVER, SPARK FREE



Art.-No.	+	mm	g	☐
18540010	PH1	80	60	1
18540020	PH2	100	95	1
18540030	PH3	150	170	1
18540040	PH4	200	280	1



1870

SCHLOSSERHAMMER, FUNKENFREI
MACHINIST'S HAMMER, SPARK FREE

Hickorystiel

Hickory handle

Art.-No.	g	l-mm-l	g	
18703000	300	300	350	1
18705000	500	320	600	1
18708000	800	350	900	1
18710000	1000	360	1100	1



1871

VORSCHLAGHAMMER, FUNKENFREI
SLEDGE HAMMER, SPARK FREE

Hickorystiel

Hickory handle

Art.-No.	g	l-mm-l	g	
18713000	3000	600	3600	1
18715000	5000	800	5600	1



1878

BÜGELSÄGEBOGEN, FUNKENFREI
HACKSAW FRAME, SPARK FREE

Art.-No.	Für Sägeblatt for saw blade mm	l-mm-l	g	
18783000	300	560	900	5



1879

SÄGEBLATT, FUNKENFREI
SAW BLADE, SPARK FREE

Art.-No.	l-mm-l	g	
18793000	300	30	5



1876

DURCHSCHLÄGER, FUNKENFREI
SECTION PUNCH, SPARK FREE

Art.-No.	Ø mm	l-mm-l	g	
18760030	3	120	40	5
18760040	4	120	40	5
18760060	6	120	70	5
18760080	8	120	70	5
18760100	10	120	200	5



1874

KÖRNER, FUNKENFREI
CENTRE PUNCH, SPARK FREE

Art.-No.	Ø mm	l-mm-l	g	
18740040	4	110	60	5



1893

DRAHTBÜRSTE, FUNKENFREI
WIRE BRUSH, SPARK FREE

Art.-No.	Reihen Rows	l-mm-l	g	
18930030	3	350	170	1
18930040	4	350	200	1
18930050	5	350	220	1



1890

FLACHFEILE, FUNKENFREI
FLAT FILE, SPARK FREE

2-Komponentenheft two component handle

Art.-No.	Größe Size	mm	g	
18902650	Hieb 1 Cut 1	265	350	1



1891

HALBRUNDFEILE, FUNKENFREI
HALF-ROUND FILE, SPARK FREE

2-Komponentenheft two component handle

Art.-No.	Größe Size	mm	g	
18912600	Hieb 1 Cut 1	260	500	1



1892

RUNDFEILE, FUNKENFREI
ROUND FILE, SPARK FREE

2-Komponentenheft two component handle

Art.-No.	Größe Size	mm	g	
18922600	Hieb 1 Cut 1	260	250	1

WGB[®]BASIC





**PROFESSIONELLES
HANDWERKZEUG
ZUM BASISPREIS**
PROFESSIONAL HANDTOOLS
PLUS BASIC PRICES

11





998

WERKZEUGKASTEN TOOL BOX

Stahlblech
lackiert
5 Fächer

sheet steel
lacquered
5 compartments

Art.-No.	H x B x T (mm) H x W x L (mm)		
9207800	200 x 430 x 200	3300	1
9230930	200 x 530 x 200	3950	1



9690

DOPPELMAULSCHLÜSSEL, DIN 3110
DOUBLE OPEN ENDED SPANNER, DIN 3110

DIN ISO 1085, ISO 3318, ISO 10102

Chrom-Vanadium Stahl
verchromt

Art.-No.	Ø _h mm	l-mm-l	g	📦
96906073	6 x 7	123	18	10
96908093	8 x 9	142	29	10
96908103	8 x 10	142	34	10
96910113	10 x 11	159	51	10
96910133	10 x 13	171	66	10
96911133	11 x 13	171	70	10
96912133	12 x 13	171	70	10
96912143	12 x 14	175	74	10
96913143	13 x 14	175	76	10
96913153	13 x 15	186	88	10
96913163	13 x 16	187	90	10
96913173	13 x 17	200	115	10
96914153	14 x 15	186	92	10
96914173	14 x 17	200	120	10
96916173	16 x 17	200	132	10
96916183	16 x 18	200	134	10
96917193	17 x 19	219	145	10
96918193	18 x 19	219	155	10
96918213	18 x 21	235	200	10

DIN ISO 1085, ISO 3318, ISO 10102

Chrome-Vanadium steel
chrome plated

Art.-No.	Ø _h mm	l-mm-l	g	📦
96919223	19 x 22	237	220	10
96919243	19 x 24	240	234	10
96920223	20 x 22	237	220	10
96921233	21 x 23	247	226	10
96922243	22 x 24	247	253	10
96924263	24 x 26	264	340	10
96924273	24 x 27	264	345	10
96924303	24 x 30	278	425	10
96925283	25 x 28	278	352	10
96927303	27 x 30	299	454	10
96927323	27 x 32	299	460	10
96930323	30 x 32	299	540	5
96930343	30 x 34	299	480	5
96930363	30 x 36	308	506	5
96932363	32 x 36	308	596	5
96934363	34 x 36	328	740	5
96936413	36 x 41	353	880	5
96941463	41 x 46	419	1300	1
96946503	46 x 50	475	1674	1

9690 S

DOPPELMAULSCHLÜSSEL-SATZ, DIN 3110
DOUBLE OPEN ENDED SPANNER SET, DIN 3110

DIN ISO 1085, ISO 3318, ISO 10102

Chrom-Vanadium Stahl | verchromt | im Sichtkarton



DIN ISO 1085, ISO 3318, ISO 10102

Chrome-Vanadium steel | chrome plated | in display cardboard box

Art.-No.	No.	Ø _h mm	g	📦
96900023	9690S/8	6 x 7 8 x 9 10 x 11 12 x 13 14 x 15 16 x 17 18 x 19 20 x 22	764	1
96900033	9690S/12	6 x 7 8 x 9 10 x 11 12 x 13 14 x 15 16 x 17 18 x 19 20 x 22 21 x 23 24 x 27 25 x 28 30 x 32	2265	1





9690 K

DOPPELMAULSCHLÜSSEL-SATZ, DIN 3110
DOUBLE OPEN ENDED SPANNER SET, DIN 3110

DIN ISO 1085, ISO 3318, ISO 10102
Chrom-Vanadium Stahl
verchromt
im Karton

DIN ISO 1085, ISO 3318, ISO 10102
Chrome-Vanadium steel
chrome plated
in cardboard box

Art.-No.	No.	Ømm		
96900243	9690K/9	6 x 7 8 x 9 10 x 11 12 x 13 14 x 15 17 x 19 19 x 22 24 x 27 30 x 32	1509	1
96900073	9690K/10	6 x 7 8 x 9 10 x 11 12 x 13 14 x 15 16 x 17 18 x 19 20 x 22 24 x 27 30 x 32	1536	1
96900083	9690K/11	6 x 7 8 x 9 10 x 11 12 x 13 14 x 15 16 x 17 18 x 19 20 x 22 21 x 23 24 x 27 30 x 32	1890	1
96900183	9690K/12	6 x 7 8 x 9 10 x 11 10 x 13 12 x 13 14 x 15 16 x 17 17 x 19 18 x 19 20 x 22 24 x 27 30 x 32	1750	1





9690 RT

DOPPELMAULSCHLÜSSEL-SATZ, DIN 3110
DOUBLE OPEN ENDED SPANNER SET, DIN 3110

DIN ISO 1085, ISO 3318, ISO 10102
Chrom-Vanadium Stahl
verchromt
in Rolltasche

DIN ISO 1085, ISO 3318, ISO 10102
Chrome-Vanadium steel
chrome plated
in roll pouch

Art.-No.	No.	Ømm		
96900203	9690RT/8	6 x 7 8 x 9 10 x 11 12 x 13 14 x 15 16 x 17 18 x 19 20 x 22	1259	1
96900213	9690RT/12	6 x 7 8 x 9 10 x 11 12 x 13 14 x 15 16 x 17 18 x 19 20 x 22 21 x 23 24 x 27 25 x 28 30 x 32	2601	1



9230

RINGMAULSCHLÜSSEL, RINGSEITE 15° ABGEWINKELT, DIN 3113 A
COMBINATION SPANNER, RING 15° OFFSET, DIN 3113 A

ISO 3318, ISO 7738
Chrom-Vanadium Stahl
verchromt

ISO 3318, ISO 7738
Chrome-Vanadium steel
chrome plated

Art.-No.	Ø _{mm}	l-mm-l	g	☐
92300603	6	103	18	10
92300703	7	112	22	10
92300803	8	124	27	10
92300903	9	133	32	10
92301003	10	141	45	10
92301103	11	155	50	10
92301203	12	160	57	10
92301303	13	174	76	10
92301403	14	182	90	10
92301503	15	192	98	10
92301603	16	205	115	10
92301703	17	210	132	10
92301803	18	218	150	10
92301903	19	229	170	10
92302003	20	238	177	10

Art.-No.	Ø _{mm}	l-mm-l	g	☐
92302103	21	248	215	10
92302203	22	259	248	10
92302303	23	281	310	5
92302403	24	290	312	5
92302503	25	300	412	5
92302603	26	309	435	5
92302703	27	310	432	5
92302803	28	320	489	5
92302903	29	329	490	5
92303003	30	364	590	5
92303203	32	369	612	5
92303603	36	385	800	5
92304103	41	440	1100	5
92304603	46	492	1730	5

9230 S

RINGMAULSCHLÜSSEL-SATZ, RINGSEITE 15° ABGEWINKELT, DIN 3113 A
COMBINATION SPANNER SET, RING 15° OFFSET, DIN 3113 A

ISO 3318, ISO 7738
Chrom-Vanadium Stahl
verchromt
im Sichtkarton

ISO 3318, ISO 7738
Chrome-Vanadium steel
chrome plated
in display cardboard box



Art.-No.	No.	Ø _{mm}	g	☐
92300013	9230S/8	8 9 10 11 13 14 17 19	696	1
92300053	9230S/12	6 7 8 9 10 11 12 13 14 17 19 22	1050	1
92300213	9230S/012	10 11 12 13 14 17 19 22 24 27 30 32	2900	1
92300263	9230S/26	6 7 8 9 10 11 12 13 14 15 16 17 18 19 20 21 22 23 24 25 26 27 28 29 30 32	4950	1

9230 K

**RINGMAULSCHLÜSSEL-SATZ,
RINGSEITE 15° ABGEWINKELT, DIN 3110**
COMBINATION SPANNER SET,
RING 15° OFFSET, DIN 3110

DIN ISO 1085, ISO 3318,
ISO 10102
Chrom-Vanadium Stahl
verchromt
im Karton

DIN ISO 1085, ISO 3318,
ISO 10102
Chrome-Vanadium steel
chrome plated
in cardboard box



Art.-No.	No.	mm	g	Box
92300043	9230K/10	6 7 8 10 11 13 14 17 19 22	972	1
92300163	9230K/010	10 11 13 14 17 19 22 24 27 30	1950	1
92300023	9230K/11	6 7 8 10 11 13 14 16 17 18 19	750	1
92300063	9230K/12	6 7 8 9 10 11 12 13 14 17 19 22	2400	1
92300073	9230K/012	6 7 8 10 13 17 19 22 24 27 30 32	1500	1
92300193	9230K/16	6 7 8 9 10 11 12 13 14 17 19 22 24 27 30 32	2600	1
92300033	9230K/17	6 7 8 9 10 11 12 13 14 15 16 17 18 19 20 22 24	1550	1
92300273	9230K/20	6 7 8 9 10 11 12 13 14 15 16 17 18 19 21 22 24 27 30 32	3300	1

9230 RT

**RINGMAULSCHLÜSSEL-SATZ,
RINGSEITE 15° ABGEWINKELT, DIN 3113 A**
COMBINATION SPANNER SET, RING 15° OFFSET, DIN 3113 A

ISO 3318, ISO 7738
Chrom-Vanadium Stahl
verchromt
in Rolltasche

ISO 3318, ISO 7738
Chrome-Vanadium steel
chrome plated
in roll pouch



Art.-No.	No.	mm	g	Box
92300353	9230RT/8	8 9 10 11 13 14 17 19	638	1
92300363	9230RT/12	6 7 8 9 10 11 12 13 14 17 19 22	923	1
92300373	9230RT/012	10 11 12 13 14 17 19 22 24 27 30 32	2620	1
92300253	9230RT/25	6 7 8 9 10 11 12 13 14 15 16 17 18 19 20 21 22 23 24 25 26 27 28 30 32	5170	1



9290

DOPPELRINGSCHLÜSSEL, GEKRÖPFT, DIN 838
DOUBLE ENDED RING SPANNER, OFFSET, DIN 838

ISO 1085, ISO 3318, ISO 10104
Chrom-Vanadium Stahl
verchromt

ISO 1085, ISO 3318, ISO 10104
Chrome-Vanadium steel
chrome plated

Art.-No.	Ø _h mm	l mm	g	📦
92906073	6 x 7	180	50	10
92908093	8 x 9	190	70	10
92908103	8 x 10	190	67	10
92909113	9 x 11	203	76	10
92910113	10 x 11	203	100	10
92910133	10 x 13	210	115	10
92911133	11 x 13	214	115	10
92912133	12 x 13	213	130	10
92913143	13 x 14	227	135	10
92913153	13 x 15	227	125	10
92913173	13 x 17	250	164	10
92914153	14 x 15	227	150	10
92914173	14 x 17	250	163	10
92916173	16 x 17	250	190	10
92916183	16 x 18	252	178	10
92917193	17 x 19	260	223	10
92918193	18 x 19	260	265	10
92919223	19 x 22	280	291	5
92919243	19 x 24	309	350	5

Art.-No.	Ø _h mm	l mm	g	📦
92920223	20 x 22	280	330	5
92921233	21 x 23	309	380	5
92922243	22 x 24	314	380	5
92924263	24 x 26	323	420	5
92924273	24 x 27	323	440	5
92924303	24 x 30	343	492	5
92925283	25 x 28	343	497	5
92927303	27 x 30	347	548	5
92927323	27 x 32	359	548	5
92930323	30 x 32	363	660	5
92930343	30 x 34	397	850	1
92930363	30 x 36	399	873	1
92932363	32 x 36	402	950	1
92934363	34 x 36	443	1020	1
92936413	36 x 41	452	1274	1
92941463	41 x 46	505	1425	1
92946503	46 x 50	542	1750	1
92955603	55 x 60	610	3200	1
92965703	65 x 70	690	4750	1

9290 S

DOPPELRINGSCHLÜSSEL-SATZ, GEKRÖPFT, DIN 838
DOUBLE ENDED RING SPANNER SET, OFFSET, DIN 838

ISO 1085, ISO 3318, ISO 10104
Chrom-Vanadium Stahl | verchromt | im Sichtkarton



ISO 1085, ISO 3318, ISO 10104
Chrome-Vanadium steel | chrome plated | in display cardboard box

Art.-No.	No.	Ø _h mm	g	📦
92900023	9290S/8	6 x 7 8 x 9 10 x 11 12 x 13 14 x 15 16 x 17 18 x 19 20 x 22	1370	1
92900033	9290S/12	6 x 7 8 x 9 10 x 11 12 x 13 14 x 15 16 x 17 18 x 19 20 x 22 21 x 23 24 x 27 25 x 28 30 x 32	3350	1



9290 K

DOPPELRINGSCHLÜSSEL-SATZ, GEKRÖPFT, DIN 838
 DOUBLE ENDED RING SPANNER SET, OFFSET, DIN 838

ISO 1085, ISO 3318, ISO 10104
 Chrom-Vanadium Stahl
 verchromt
 im Karton

ISO 1085, ISO 3318, ISO 10104
 Chrome-Vanadium steel
 chrome plated
 in cardboard box

Art.-No.	No.	mm	g	
92900083	9290K/10	6 x 7 8 x 9 10 x 11 12 x 13 14 x 15 16 x 17 18 x 19 20 x 22 21 x 23 24 x 27	2410	1

9290 RT

DOPPELRINGSCHLÜSSEL-SATZ, GEKRÖPFT, DIN 838
 DOUBLE ENDED RING SPANNER SET, OFFSET, DIN 838

ISO 1085, ISO 3318, ISO 10104
 Chrom-Vanadium Stahl | verchromt
 in Rolltasche

ISO 1085, ISO 3318, ISO 10104
 Chrome-Vanadium steel | chrome plated
 in roll pouch



Art.-No.	No.	mm	g	
92900193	9290RT/8	6 x 7 8 x 9 10 x 11 12 x 13 14 x 15 16 x 17 18 x 19 20 x 22	1576	1
92900203	9290RT/12	6 x 7 8 x 9 10 x 11 12 x 13 14 x 15 16 x 17 18 x 19 20 x 22 21 x 23 24 x 27 25 x 28 30 x 32	3455	1



9215

DOPPELRINGSCHLÜSSEL AUSSEN-TORX®-SCHRAUBEN
 DOUBLE ENDED RING SPANNER FOR OUTSIDE TORX® SCREWS

Chrom-Vanadium Stahl
 verchromt

Chrome-Vanadium steel
 chrome plated

Art.-No.	mm	mm-l	g	
921506083	E6 x E8	110	22	10
921510123	E10 x E12	140	46	10

Art.-No.	mm	mm-l	g	
921514183	E14 x E18	180	96	10
921520243	E20 x E24	223	172	10



9210

DOPPELRINGSCHLÜSSEL, GERADE, DIN 837 B
 DOUBLE ENDED RING SPANNER, STRAIGHT, DIN 837 B

ISO 1085, ISO 3318
 Chrom-Vanadium Stahl
 verchromt

ISO 1085, ISO 3318
 Chrome-Vanadium steel
 chrome plated

Art.-No.	Ø mm	l mm	g	Box
92106073	6 x 7	97	18	10
92108093	8 x 9	111	22	10
92108103	8 x 10	117	25	10
92110113	10 x 11	127	35	10
92110133	10 x 13	142	41	10
92112133	12 x 13	142	48	10
92112143	12 x 14	142	61	10
92113153	13 x 15	155	65	10
92113173	13 x 17	166	75	10
92114153	14 x 15	155	65	10

Art.-No.	Ø mm	l mm	g	Box
92116173	16 x 17	170	60	10
92117193	17 x 19	185	100	10
92118193	18 x 19	185	80	10
92119223	19 x 22	208	139	10
92120223	20 x 22	201	135	10
92121233	21 x 23	214	150	10
92122243	22 x 24	214	165	10
92124273	24 x 27	262	184	10
92125283	25 x 28	263	270	10
92130323	30 x 32	283	333	10



9675

STARTER- UND BLOCKSCHLÜSSEL
 HALF MOON RING SPANNER

Chrom-Vanadium Stahl
 verchromt

Chrome-Vanadium steel
 chrome plated

Art.-No.	Ø mm	l mm	g	Box
99224343	11 x 13	150	79	10
99202933	12 x 13	151	54	10
99202943	13 x 15	170	110	10
99202973	14 x 16	183	143	10

Art.-No.	Ø mm	l mm	g	Box
99202953	14 x 17	185	164	10
99202983	15 x 17	181	164	10
99202993	16 x 18	200	164	10
99202963	19 x 22	218	257	10

Satz auf Anfrage | Set on request



9240

DOPPELRINGSCHLÜSSEL, OFFEN, DIN 3118 A
FLARE NUT SPANNER, DIN 3118 A

Chrom-Vanadium Stahl
verchromt

Chrome-Vanadium steel
chrome plated

Art.-No.	Ømm	l-mm-l	g	☐
92408093	8 x 9	134	41	10
92408103	8 x 10	135	40	10
92409113	9 x 11	152	56	10
92410113	10 x 11	145	50	10
92410123	10 x 12	152	54	10
92411133	11 x 13	170	108	10
92412143	12 x 14	174	96	10
92413153	13 x 15	165	104	10

Art.-No.	Ømm	l-mm-l	g	☐
92414163	14 x 16	186	122	10
92414173	14 x 17	182	144	10
92416183	16 x 18	205	158	10
92417193	17 x 19	198	156	10
92419223	19 x 22	203	260	5
92422243	22 x 24	226	330	5
92424273	24 x 27	254	422	5
92430323	30 x 32	275	392	5



9240 K

DOPPELRINGSCHLÜSSEL-SATZ, OFFEN, DIN 3118 A
FLARE NUT SPANNER SET, DIN 3118 A

Chrom-Vanadium Stahl
verchromt
im Karton

Chrome-Vanadium steel
chrome plated
in cardboard box

Art.-No.	Ømm	g	☐
92400103	8 x 10 9 x 11 11 x 13 12 x 14 13 x 15 16 x 18 17 x 19 19 x 22 24 x 27 30 x 32	1810	1



9235

RINGMAULSCHLÜSSEL MIT RATSCH COMBINATION GEAR WRENCH

DIN ISO 691, DIN ISO 1711
Chrom-Vanadium Stahl
verchromt
abgewinkelt
umschaltbar
72 Zähne

DIN ISO 691, DIN ISO 1711
Chrome-Vanadium steel
chrome plated
offset
reversible
72 teeth

Art.-No.	Ø mm	l mm	g	Box
923500083	8	134	35	10
923500093	9	158	62	10
923500103	10	158	60	10
923500113	11	164	72	10
923500123	12	167	84	10
923500133	13	177	100	10
923500143	14	190	120	10

Art.-No.	Ø mm	l mm	g	Box
923500153	15	198	140	10
923500163	16	204	160	10
923500173	17	224	180	10
923500183	18	235	212	10
923500193	19	247	242	10
923500223	22	280	374	10
923500243	24	310	500	10



9235 RT

RINGMAULSCHLÜSSEL-SATZ MIT RATSCH COMBINATION GEAR WRENCH SET

DIN ISO 691, DIN ISO 1711
Chrom-Vanadium Stahl
verchromt
abgewinkelt
in Rolltasche
umschaltbar
72 Zähne

DIN ISO 691, DIN ISO 1711
Chrome-Vanadium steel
chrome plated
offset
in roll pouch
reversible
72 teeth

Art.-No.	No.	Inhalt Content	g	Box
923500983	9235RT/5	8 10 13 17 19	850	1
923500973	9235RT/8	8 10 13 14 15 17 19 22	1350	1



9236

RINGMAULSCHLÜSSEL MIT RATSCH COMBINATION GEAR WRENCH

DIN ISO 691, DIN ISO 1711
Chrom-Vanadium Stahl
verchromt
gerade
72 Zähne

DIN ISO 691, DIN ISO 1711
Chrome-Vanadium steel
chrome plated
straight
72 teeth

Art.-No.	mm	mm-l	g	
923600083	8	134	40	10
923600103	10	159	62	10
923600133	13	178	100	10

Art.-No.	mm	mm-l	g	
923600173	17	224	190	10
923600193	19	247	244	10



9236 RT

RINGMAULSCHLÜSSEL-SATZ MIT RATSCH COMBINATION GEAR WRENCH SET

DIN ISO 691, DIN ISO 1711
Chrom-Vanadium-Stahl
verchromt
gerade
in Rolltasche
72 Zähne

DIN ISO 691, DIN ISO 1711
Chrome-Vanadium steel
chrome plated
straight
in roll pouch
72 teeth

Art.-No.	No.	Inhalt Content	g	
923600983	9236RT/5	8 10 13 17 19	850	1



9295

DOPPELRING-RATSCHENSCHLÜSSEL DOUBLE-BOX GEAR WRENCH

DIN ISO 691, DIN ISO 1711
Chrom-Vanadium Stahl | verchromt
abgewinkelt
beidseitig umschaltbar
72 Zähne

DIN ISO 691, DIN ISO 1711
Chrome-Vanadium steel | chrome plated
offset
reversible on both sides
72 teeth

Art.-No.	mm	mm	g	
929508093	8 x 9	130	59	10
929510113	10 x 11	144	73	10
929512133	12 x 13	166	100	10

Art.-No.	mm	mm	g	
929514153	14 x 15	181	150	10
929517193	17 x 19	224	222	10

9295 RT

DOPPELRING-RATSCHENSCHLÜSSEL-SATZ DOUBLE-BOX GEAR WRENCH SET

DIN ISO 691, DIN ISO 1711
Chrom-Vanadium Stahl | verchromt
in Rolltasche
72 Zähne
abgewinkelt
beidseitig umschaltbar

DIN ISO 691, DIN ISO 1711
Chrome-Vanadium steel | chrome plated
in roll pouch
72 teeth
offset
reversible on both sides



Art.-No.	No.	Inhalt Content	g	
929500023	9295RT/5	8 x 9 10 x 11 12 x 13 14 x 15 17 x 19	809	1



9580

GELENK-STECKSCHLÜSSEL COMBINATION SWIVEL HEAD WRENCH

Chrom-Vanadium Stahl
verchromt

Chrome-Vanadium steel
chrome plated

Art.-No.	Ø mm	l mm	g	Box
95800803	8	161	55	10
95801003	10	182	79	10
95801203	12	211	145	10

Art.-No.	Ø mm	l mm	g	Box
95801303	13	207	143	10
95801603	16	246	236	10
95801703	17	245	190	10



920

ROLLGABELSCHLÜSSEL ADJUSTABLE WRENCH

Spezial-Werkzeugstahl
verchromt
Griff mit Aufhängeloch

Special Carbon steel
chrome plated
handle with hanging hole

Art.-No.	l	Ø mm	l mm	g	Box
9203888	6"	max. 19	150	165	10
9204078	8"	max. 24	200	270	10
9204198	10"	max. 29	250	450	5
9204208	12"	max. 33	300	770	5
9219478	15"	max. 41	380	1170	5
9265758	18"	max. 52	450	1974	5
9288108	24"	max. 64	600	3822	5



9649

EINMAULSCHLÜSSEL, DIN 894
SINGLE OPEN ENDED SPANNER, DIN 894

DIN ISO 1085, ISO 3318
Spezial-Werkzeugstahl
verchromt

DIN ISO 1085, ISO 3318
Special Carbon steel
chrome plated

Art.-No.	Ø _{mm}	l-mm-l	g	📦
6400609	6	73	6	20
6400709	7	78	8	20
6400809	8	94	15	20
6400909	9	100	20	20
6401009	10	106	22	20
6401109	11	110	23	20
6401209	12	123	31	20
6401309	13	130	37	20
6401409	14	148	47	20
6401509	15	148	61	20
6401609	16	156	71	20
6401709	17	159	81	10
6401809	18	163	89	10
6401909	19	173	98	10
6402009	20	182	105	10
6402109	21	183	107	10
6402209	22	194	139	10
6402409	24	213	165	10
6402509	25	230	179	10

Art.-No.	Ø _{mm}	l-mm-l	g	📦
6402609	26	234	179	10
6402709	27	234	210	10
6403009	30	260	290	10
6403209	32	275	333	10
6403409	34	285	340	10
6403609	36	300	461	5
6403809	38	297	467	5
6404109	41	338	577	5
6404609	46	375	682	5
6405009	50	404	1134	1
6405509	55	446	1250	1
6406009	60	483	1650	1
6406509	65	504	2010	1
6407009	70	555	2700	1
6407509	75	602	2600	1
6408009	80	635	3600	1
6408509	85	670	4350	1
6409509	95	860	5800	1



9640

EINMAULSCHLÜSSEL, DIN 894

SINGLE OPEN ENDED SPANNER, DIN 894

DIN ISO 1085, ISO 3318

Spezial-Werkzeugstahl bis 95 mm,
Chrom-Vanadium Stahl ab 100 mm
schwarz

DIN ISO 1085, ISO 3318

Special Carbon steel up to 95 mm,
Chrome-Vanadium steel from 100 mm
black

Art.-No.	Ø mm	l mm	g	Box
6400600	6	73	6	20
6400700	7	78	8	20
6400800	8	94	15	20
6400900	9	100	20	20
6401000	10	106	22	20
6401100	11	110	23	20
6401200	12	123	31	20
6401300	13	129	37	20
6401400	14	148	47	20
6401500	15	147	61	20
6401600	16	156	71	20
6401700	17	159	81	10
6401800	18	163	89	10
6401900	19	173	98	10
6402000	20	182	115	10
6402100	21	182	107	10
6402200	22	194	139	10
6402400	24	213	165	10
6402500	25	230	179	10
6402700	27	233	210	10
6403000	30	260	290	10
6403200	32	275	333	10
6403400	34	285	340	10

Art.-No.	Ø mm	l mm	g	Box
6403600	36	299	500	5
6403800	38	298	467	5
6404100	41	338	590	5
6404600	46	374	682	5
6405000	50	403	1134	1
6405500	55	444	1250	1
6405800	58	447	1265	1
6406000	60	483	1650	1
6406500	65	504	2010	1
6407000	70	555	2700	1
6407500	75	600	2600	1
6408000	80	635	3500	1
6408500	85	670	4024	1
6409000	90	670	4800	1
6409500	95	860	6882	1
6410000	100	860	6046	1
6410500	105	900	6200	1
6411000	110	910	6350	1
6411500	115	950	6400	1
6412000	120	1005	8200	1
6412500	125	1005	7650	1
6413000	130	1005	7400	1
6413507	135	1005	7800	1



9659

DOPPELMAULSCHLÜSSEL, DIN 895
DOUBLE OPEN ENDED SPANNER, DIN 895

DIN ISO 1085, ISO 3318
Spezial-Werkzeugstahl bis 50 x 55 mm,
Chrom-Vanadium Stahl ab 55 x 60 mm
verchromt

DIN ISO 1085, ISO 3318
Special Carbon steel up to 50 x 55 mm,
Chrome-Vanadium steel from 55 x 60 mm
chrome plated

Art.-No.	Ø mm	l mm	g	Box
6506079	6 x 7	97	14	20
6507089	7 x 8	107	16	20
6508099	8 x 9	109	20	20
6508109	8 x 10	115	23	20
6509119	9 x 11	120	30	20
6510119	10 x 11	119	29	20
6510139	10 x 13	123	34	20
6511139	11 x 13	133	40	20
6512139	12 x 13	141	43	10
6512149	12 x 14	141	45	10
6513149	13 x 14	141	46	10
6513159	13 x 15	145	55	10
6513179	13 x 17	155	71	10
6514159	14 x 15	146	57	10
6514179	14 x 17	157	76	10
6516179	16 x 17	164	77	10
6516189	16 x 18	166	92	10
6517199	17 x 19	168	92	10
6517229	17 x 22	184	110	10
6518199	18 x 19	172	110	10

Art.-No.	Ø mm	l mm	g	Box
6518219	18 x 21	181	118	10
6519229	19 x 22	190	137	10
6519249	19 x 24	206	165	10
6520229	20 x 22	197	160	10
6521239	21 x 23	217	200	10
6522249	22 x 24	215	200	10
6524279	24 x 27	239	260	10
6524309	24 x 30	274	334	10
6525289	25 x 28	240	260	10
6527309	27 x 30	264	326	10
6527329	27 x 32	270	375	10
6530329	30 x 32	276	410	5
6530369	30 x 36	297	466	5
6532369	32 x 36	332	530	5
6534369	34 x 36	320	716	5
6536419	36 x 41	336	760	5
6541469	41 x 46	385	1202	1
6546509	46 x 50	421	1200	1
6550559	50 x 55	458	1750	1
6555609	55 x 60	495	1842	1



9650

DOPPELMAULSCHLÜSSEL, DIN 895 DOUBLE OPEN ENDED SPANNER, DIN 895

DIN ISO 1085, ISO 3318
Spezial-Werkzeugstahl bis 50 x 55 mm,
Chrom-Vanadium Stahl ab 55 x 60 mm
schwarz

DIN ISO 1085, ISO 3318
Special Carbon steel up to 50 x 55 mm,
Chrome-Vanadium steel from 55 x 60 mm
black

Art.-No.	Ø mm	l mm	g	Box
6506070	6 x 7	97	14	20
6507080	7 x 8	107	16	20
6508090	8 x 9	109	20	20
6508100	8 x 10	115	23	20
6509110	9 x 11	120	30	20
6510110	10 x 11	119	29	20
6510130	10 x 13	123	34	20
6510140	10 x 14	138	44	20
6511130	11 x 13	133	40	20
6512130	12 x 13	141	43	10
6512140	12 x 14	141	45	10
6513140	13 x 14	141	46	10
6513150	13 x 15	145	55	10
6513160	13 x 16	148	68	10
6513170	13 x 17	155	71	10
6514150	14 x 15	146	57	10
6514170	14 x 17	157	70	10
6516170	16 x 17	164	77	10
6516180	16 x 18	166	92	10
6517190	17 x 19	168	100	10
6517220	17 x 22	185	127	10
6518190	18 x 19	172	110	10
6518210	18 x 21	181	118	10
6519220	19 x 22	195	150	10

Art.-No.	Ø mm	l mm	g	Box
6519240	19 x 24	206	165	10
6520220	20 x 22	197	160	10
6521230	21 x 23	217	210	10
6522240	22 x 24	215	192	10
6522270	22 x 27	230	260	10
6524270	24 x 27	239	260	10
6524300	24 x 30	274	334	10
6524320	24 x 32	275	300	10
6525280	25 x 28	234	233	10
6527300	27 x 30	272	340	10
6527320	27 x 32	270	375	10
6530320	30 x 32	276	410	10
6530340	30 x 34	280	420	10
6530360	30 x 36	297	466	5
6532360	32 x 36	332	530	5
6534360	34 x 36	320	716	5
6536410	36 x 41	336	760	5
6541460	41 x 46	385	1020	5
6546500	46 x 50	421	1200	1
6550550	50 x 55	458	1750	1
6555600	55 x 60	495	1842	1
6565700	65 x 70	580	3500	1
6575800	75 x 80	660	5200	1



9450

DOPPELSEITIGER ROHRSTECKSCHLÜSSEL, DIN 896 B DOUBLE ENDED TUBULAR BOX WRENCH, DIN 896 B

ISO 1085, ISO 2236
nahtlos gezogenes Präzisions-
Stahlrohr, gehärtet
verchromt

ISO 1085, ISO 2236
seamless rifled precision
steel tube, hardened
chrome plated

Art.-No.	Ø mm	mm	l mm	g	Icon
94506073	6 x 7	6 x 160	103	36	10
94508093	8 x 9	6 x 160	105	38	10
94508103	8 x 10	6 x 160	120	46	10
94510113	10 x 11	6 x 160	119	73	10
94510133	10 x 13	8 x 180	140	90	10
94512133	12 x 13	8 x 180	140	85	10
94512143	12 x 14	8 x 180	145	91	10
94513143	13 x 14	8 x 180	132	70	10
94513153	13 x 15	8 x 180	140	94	10
94513173	13 x 17	10 x 200	154	116	10
94514153	14 x 15	8 x 180	140	94	10
94514173	14 x 17	10 x 200	152	125	10
94516173	16 x 17	10 x 200	154	118	10
94517193	17 x 19	12 x 250	155	175	10
94518193	18 x 19	12 x 250	155	170	10
94519223	19 x 22	12 x 250	169	230	10
94520223	20 x 22	12 x 250	169	235	5
94521233	21 x 23	14 x 320	168	238	5
94522243	22 x 24	14 x 320	183	344	5
94524263	24 x 26	14 x 320	190	360	5
94524273	24 x 27	14 x 320	189	370	5
94525283	25 x 28	14 x 320	200	390	5
94527303	27 x 30	16 x 400	196	424	5
94527323	27 x 32	16 x 400	205	392	5
94530323	30 x 32	16 x 400	200	395	5
94530363	30 x 36	18 x 400	220	545	5
94532363	32 x 36	18 x 400	218	600	5
94536413	36 x 41	18 x 400	222	658	5
94541463	41 x 46	20 x 500	242	966	1
94546503	46 x 50	20 x 500	245	927	1
94550553	50 x 55	20 x 500	242	1670	1

Satz auf Anfrage | Set on request

9455

DOPPELSEITIGER ROHRSTECKSCHLÜSSEL DOUBLE ENDED TUBULAR BOX WRENCH

Chrom-Vanadium Stahl
verchromt
massiv

Chrome-Vanadium steel
chrome plated
heavy duty pattern

Art.-No.	Ø mm	mm	l mm	g	Icon
945506073	6 x 7	3 x 110	105	37	10
945508093	8 x 9	3 x 110	110	52	10
945510113	10 x 11	5 x 125	120	72	10
945512133	12 x 13	5 x 125	140	117	10
945514153	14 x 15	6 x 160	145	145	10
945516173	16 x 17	8 x 180	155	189	10
945517193	17 x 19	8 x 180	165	233	10
945518193	18 x 19	8 x 180	165	242	10
945520223	20 x 22	10 x 200	175	306	5
945521233	21 x 23	10 x 200	185	340	5
945524263	24 x 26	10 x 200	194	481	5
945524273	24 x 27	10 x 200	195	493	5
945525283	25 x 28	10 x 200	202	481	5
945530323	30 x 32	12 x 250	210	725	5

Satz auf Anfrage | Set on request

9423

STUFEN-DREHSTIFT STEPPED TOMMY BAR

Chrom-Vanadium Stahl
verchromt

Chrome-Vanadium steel
chrome plated



Art.-No.	∅ mm	l-mm-l	g	☐
9200765	5 8 10 12	230	165	10
9200753	5 6 8 10 12	271	176	10

9462

RAD-STECKSCHLÜSSEL DOUBLE ENDED WHEEL NUT WRENCH

Spezial-Werkzeugstahl
chromfarbig lackiert
massiv

Special Carbon steel
silver finished
heavy duty pattern



Art.-No.	∅ mm	mm	l-mm-l	g	☐
946224273	24 x 27	19 x 400	405	1280	1
946227303	27 x 30	19 x 400	405	2900	1
946230323	30 x 32	19 x 400	450	2970	1
946232383	32 x 38	19 x 400	505	3640	1

9470

STECKSCHLÜSSEL, ABGEWINKELT SOCKET WRENCH, ANGLED

Spezial-Werkzeugstahl
chromfarbig lackiert
massiv

Special Carbon steel
silver finished
heavy duty pattern

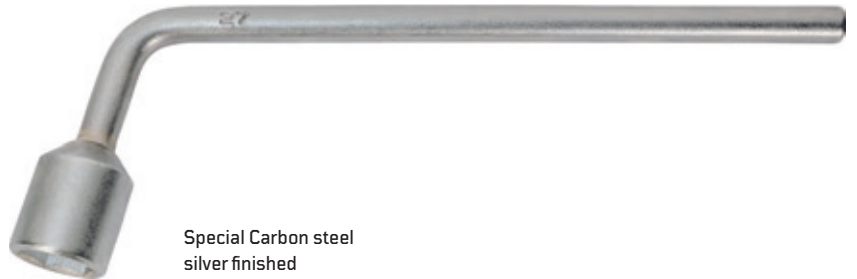

Art.-No.	∅ mm	l-mm-l	g	☐
94701700	17	275	465	1
94701900	19	275	470	1
94702200	22	275	480	1
94702400	24	275	660	1
94702700	27	275	665	1

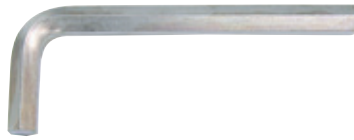

9308



SECHSKANT-STIFTSCHLÜSSEL, DIN ISO 2936
HEXAGON KEY WRENCH, DIN ISO 2936

Spezial-Werkzeugstahl | vernickelt
ungefast

Special Carbon steel | nickel plated
unchamfered

Art.-No.	mm	mm	g	
93090159	1,5	45 x 14	1	500
93090209	2	50 x 16	1	500
93090259	2,5	56 x 18	2	500
93090309	3	63 x 20	5	500
93090409	4	70 x 25	10	300
93090509	5	80 x 28	17	200
93090609	6	90 x 32	30	200
93090709	7	95 x 35	37	200
93090809	8	100 x 35	59	200
93091009	10	112 x 40	103	100
93091209	12	125 x 45	168	100
93091409	14	140 x 55	254	100
93091709	17	160 x 60	425	50
93091909	19	175 x 70	601	50
93092209	22	200 x 80	917	50



9309



SECHSKANT-STIFTSCHLÜSSEL, DIN ISO 2936
HEXAGON KEY WRENCH, DIN ISO 2936

Spezial-Werkzeugstahl | schwarz
ungefast

Special Carbon steel | black
unchamfered

Art.-No.	mm	mm	g	
93090150	1,5	45 x 14	1	500
93090200	2	50 x 16	1	500
93090250	2,5	56 x 18	2	500
93090300	3	63 x 20	5	500
93090400	4	70 x 25	10	300
93090500	5	80 x 28	17	200
93090600	6	90 x 32	30	200
93090700	7	95 x 35	37	200
93090800	8	100 x 35	59	200
93091000	10	112 x 40	103	100
93091200	12	125 x 45	168	100
93091300	13	132 x 50	195	100
93091400	14	140 x 55	254	100
93091700	17	160 x 60	425	50
93091900	19	175 x 70	601	50
93092200	22	200 x 80	917	50
93092400	24	224 x 90	1230	
93092700	27	250 x 100	1726	
93093000	30	280 x 112	2430	
93093200	32	315 x 125	3140	
93093600	36	355 x 140	4400	
93094100	41	401 x 153	4580	
93094600	46	444 x 166	6450	
93095000	50	520 x 180	8250	
93095500	55	550 x 180	9250	



9308 PT



SECHSKANT-STIFTSCHLÜSSEL-SATZ, DIN ISO 2936
HEXAGON KEY WRENCH SET, DIN ISO 2936

Spezial-Werkzeugstahl | vernickelt
in Kunststofftasche

Special Carbon steel | nickel plated
in plastic wallet

Art.-No.	No.	mm	g	
9216276	9308PT/8	2 2,5 3 4 5 6 8 10	270	5
9216286	9308PT/9	2 2,5 3 4 5 5,5 6 8 10	261	5
9216296	9308PT/10	2 2,5 3 4 5 5,5 6 8 10 12	419	5
9216306	9308PT/11	2 2,5 3 4 5 5,5 6 8 10 12 14	649	5



9309 PTR



SECHSKANT-STIFTSCHLÜSSEL-SATZ, DIN ISO 2936
HEXAGON KEY WRENCH SET, DIN ISO 2936

Spezial-Werkzeugstahl | schwarz
am Ring

Special Carbon steel | black
on ring

Art.-No.	No.	mm	g	
9207150	9309PTR/8	2 2,5 3 4 5 6 8 10	235	10



9308 PKH

SECHSKANT-STIFTSCHLÜSSEL-SATZ
HEXAGON KEY WRENCH SET

Chrom-Vanadium Stahl
verchromt
im Handklapphalter aus Kunststoff

Chrome-Vanadium steel
chrome plated
in plastic clip

Art.-No.	No.	mm		
9245740	9308PKH/7	2,5 3 4 5 6 8 10	242	10

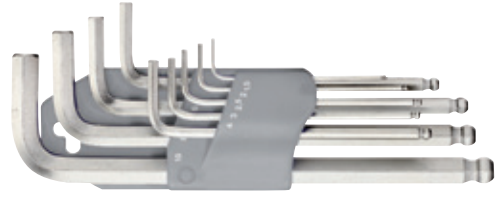

9328 KH

SECHSKANT-STIFTSCHLÜSSEL-SATZ
HEXAGON KEY WRENCH SET

Chrom-Vanadium Stahl | verchromt
im Kunststoffclip
mit Kugelkopf, extra lang

Chrome-Vanadium steel | chrome plated
in plastic clip
with ballpoint, extra long



Art.-No.	No.	mm		
9245750	9325KH/9	1,5 2 2,5 3 4 5 6 8 10	220	6



9315 PKH

TORX®-STIFTSCHLÜSSEL-SATZ
TORX® KEY WRENCH SET

Chrom-Vanadium Stahl
verchromt
im Handklapphalter aus Kunststoff

Chrome-Vanadium steel
chrome plated
in plastic clip

Art.-No.	No.			
9245760	9315PKH/8	TX9 TX10 TX15 TX20 TX25 TX27 TX30 TX40	240	10



9314 HKH

TAMPER TORX®-STIFTSCHLÜSSEL-SATZ
TAMPER TORX® KEY WRENCH SET

Chrom-Vanadium Stahl
verchromt
im Handklapphalter aus Metall

Chrome-Vanadium steel
chrome plated
in metal clip



Art.-No.	No.			
9245770	9314HKH/8	TR9 TR10 TR15 TR20 TR25 TR27 TR30 TR40	240	10

9335 HKH

VIELZAHNSTIFTSCHLÜSSEL-SATZ
MULTI-SPLINE KEY WRENCH SET

Chrom-Vanadium Stahl
schwarz
im Handklapphalter aus Metall

Chrome-Vanadium steel
black
in metal clip



Art.-No.	No.			
9239890	9335HKH/5	M5 M6 M8 M10 M12	418	5



9500

6,3 1/4"

STECKSCHLÜSSEL-EINSATZ, 6-KANT, DIN 3124
SOCKET, 6-POINT, DIN 3124

DIN 3120 C, ISO 1174-1,
ISO 2725-1
Chrom-Vanadium Stahl
verchromt

DIN 3120 C, ISO 1174-1,
ISO 2725-1
Chrome-Vanadium steel
chrome plated

Art.-No.	Ø mm	l mm-l	g	Box
95000403	4	25	10	10
95000453	4,5	25	10	10
95000503	5	25	10	10
95000553	5,5	25	10	10
95000603	6	25	10	10
95000653	6,5	25	10	10
95000703	7	25	12	10
95000803	8	25	12	10
95000903	9	25	12	10
95001003	10	25	14	10
95001103	11	25	22	10
95001203	12	25	22	10
95001303	13	25	24	10
95001403	14	25	32	10

9590

6,3 1/4"

STECKSCHLÜSSEL-EINSATZ, 6-KANT, DIN 3124
SOCKET, 6-POINT, DIN 3124

DIN 2725-1, DIN 3120 C,
ISO 1174-1
lange Ausführung
Chrom-Vanadium Stahl
verchromt

DIN 2725-1, DIN 3120 C,
ISO 1174-1
long type
Chrome-Vanadium steel
chrome plated

Art.-No.	Ø mm	l mm-l	g	Box
95900403	4	50	25	10
95900453	4,5	50	25	10
95900503	5	50	25	10
95900603	6	50	25	10
95900703	7	50	25	10
95900803	8	50	30	10
95900903	9	50	35	10
95901003	10	50	40	10
95901103	11	50	45	10
95901203	12	50	50	10
95901303	13	50	55	10
95901403	14	50	70	10



9527

6,3 1/4"

PZ SCHRAUBENDREHER-EINSATZ
PZ SCREWDRIVER SOCKET

DIN 3120 C, DIN ISO 8764-1,
ISO 1174-1
für PZ-Kreuzschlitzschrauben
Chrom-Vanadium Stahl
verchromt

DIN 3120 C, DIN ISO 8764-1,
ISO 1174-1
für PZ screws
Chrome-Vanadium steel
chrome plated

Art.-No.	Icon	l mm-l	g	Box
95270103	PZ 1	32	13	10
95270203	PZ 2	32	14	10
95270303	PZ 3	32	13	10

9503

6,3 1/4"

PH SCHRAUBENDREHER-EINSATZ
PH SCREWDRIVER SOCKET

DIN 3120 C, DIN ISO 8764-1,
ISO 1174-1
für PH-Kreuzschlitzschrauben
Chrom-Vanadium Stahl
verchromt

DIN 3120 C, DIN ISO 8764-1,
ISO 1174-1
für PH screws
Chrome-Vanadium steel
chrome plated

Art.-No.	Icon	l mm-l	g	Box
95030103	PH 1	32	14	10
95030203	PH 2	32	12	10
95030303	PH 3	32	16	10
95030403	PH 4	32	16	10



9501



6,3 1/4" 

INNENSECHSKANT-SCHRAUBENDREHER-EINSATZ, DIN 7422

INSIDE HEXAGON SCREWDRIVER SOCKET, DIN 7422

DIN 3120 C, ISO 1174-1
für Innensechskant-Schrauben
Chrom-Vanadium Stahl
verchromt

DIN 3120 C, ISO 1174-1
for inside hexagon screws
Chrome-Vanadium steel
chrome plated

Art.-No.		l-mm-l	g	
95010303	3	32	16	10
95010403	4	32	17	10
95010503	5	32	17	10
95010603	6	32	14	10
95010703	7	32	16	10
95010803	8	32	18	10
95011003	10	32	20	10





9519

6,3 1/4" 

TX SCHRAUBENDREHER-EINSATZ TX SCREWDRIVER SOCKET

DIN 3120 C, ISO 1174-1
für Innen-TORX®-Schrauben
Chrom-Vanadium Stahl
verchromt

DIN 3120 C, ISO 1174-1
for inside TORX® screws
Chrome-Vanadium steel
chrome plated

Art.-No.		l-mm-l	g	
95190803	TX8	37	16	10
95191003	TX10	37	12	10
95191503	TX15	37	14	10
95192003	TX20	37	14	10
95192503	TX25	37	14	10
95192703	TX27	37	14	10
95193003	TX30	37	16	10
95194003	TX40	37	16	10
95194503	TX45	37	20	10





9522

6,3 1/4" 

E-TX SCHRAUBENDREHER-EINSATZ E-TX SCREWDRIVER SOCKET

DIN 3120 C, ISO 1174-1
Chrom-Vanadium Stahl
verchromt

DIN 3120 C, ISO 1174-1
Chrome-Vanadium steel
chrome plated

Art.-No.		M	l-mm-l	g	
95220403	E4	3	25	11	10
95220503	E5	4	25	11	10
95220603	E6	5	25	11	10
95220703	E7	6	25	11	10
95220803	E8	6	25	12	10
95221003	E10	8	25	17	10





9502

6,3 1/4" 

SCHRAUBENDREHER-EINSATZ SCREWDRIVER SOCKET

DIN 3120 C, DIN 5264,
DIN ISO 2380-1, ISO 1174-1
für Schlitzschrauben
Chrom-Vanadium Stahl
verchromt

DIN 3120 C, DIN 5264,
DIN ISO 2380-1, ISO 1174-1
for slotted screws
Chrome Vanadium steel
chrome plated

Art.-No.		l-mm-l	g	
95020353	3,5	32	13	10
95020403	4	32	13	10
95020453	4,5	32	14	10
95020553	5,5	32	14	10
95020653	6,5	32	14	10
95020703	7	32	15	10
95020803	8	32	16	10



9507

6,3 1/4" □ □

VERLÄNGERUNG, DIN 3123 B
EXTENSION BAR, DIN 3123 B

DIN 3120 A/C, ISO 1174-1,
ISO 3316
Chrom-Vanadium Stahl
verchromt

DIN 3120 A/C, ISO 1174-1,
ISO 3316
Chrome-Vanadium steel
chrome plated

Art.-No.	l-mm-l	g	□
9239703	50	25	10
950707503	75	34	10
9239713	100	44	10
9239723	149	64	10

9529

6,3 1/4" □ □

FLEXIBLE VERLÄNGERUNG
FLEXIBLE EXTENSION

DIN 3120 A/C, ISO 1174-1
Chrom-Vanadium Stahl
verchromt

DIN 3120 A/C, ISO 1174-1
Chrome-Vanadium steel
chrome plated

Art.-No.	l-mm-l	g	□
9263240	150	42	10



9506

6,3 1/4" □ □

GRIFF MIT GLEITSTÜCK, DIN 3122 A
SLIDING T-HANDLE, DIN 3122 A

DIN 3120 A/C, ISO 1174-1,
ISO 3315
Chrom-Vanadium Stahl
verchromt

DIN 3120 A/C, ISO 1174-1,
ISO 3315
Chrome-Vanadium steel
chrome plated

Art.-No.	l-mm-l	g	□
9277293	115	10	10



9509

6,3 1/4" □ □

KARDAN-GELENK, DIN 3123 C
UNIVERSAL JOINT, DIN 3123 C

DIN 3120 A/C, ISO 1174-1,
ISO 3316
Chrom-Vanadium Stahl
verchromt

DIN 3120 A/C, ISO 1174-1,
ISO 3316
Chrome-Vanadium steel
chrome plated

Art.-No.	l-mm-l	g	□
9239543	40	28	10

9052

6,3 1/4" □ □

MASCHINEN-ADAPTER, DIN 3126
MACHINERY ADAPTOR, DIN 3126

DIN 3120 A/C, ISO 1174-1,
ISO 3316
Chrom-Vanadium Stahl
stahlgrau
1/4" außen, 1/4" außen

DIN 3120 A/C, ISO 1174-1,
ISO 3316
Chrome-Vanadium steel
grey finish
1/4" male, 1/4" male

Art.-No.	□	□	l-mm-l	g	□
9297133	1/4"	1/4"	30	6	10



9505

6,3 1/4" □

STECKGRIFF
SPINNER HANDLE

Chrom-Vanadium Stahl
verchromt

Chrome-Vanadium steel
chrome plated

Art.-No.	l-mm-l	g	□
9288133	150	60	10



9512

6,3 1/4"

HEBELUMSCHALTKNARRE, 72 ZÄHNE, DIN 3122 D
 REVERSIBLE RATCHET, LEVER TYPE, 72 TEETH, DIN 3122 D

DIN 3120 A, ISO 1174-1, ISO 3315
 Chrom-Vanadium Stahl
 verchromt
 2-Komponentenheft

DIN 3120 A, ISO 1174-1, ISO 3315
 Chrome-Vanadium steel
 chrome plated
 two component handle

Art.-No.		l-mm-l		
9239343	72	140	132	10

9510

6,3 1/4"

Gelenk-HEBELUMSCHALTKNARRE, DIN 3122 D
 TURNABLE REVERSIBLE RATCHET, LEVER TYPE, DIN 3122 D

DIN 3120 A, ISO 1174-1, ISO 3315
 Chrom-Vanadium Stahl
 verchromt
 mit Feststellfunktion
 2-Komponentenheft

DIN 3120 A, ISO 1174-1, ISO 3315
 Chrome-Vanadium steel
 chrome plated
 with locking function
 two component handle

Art.-No.		l-mm-l		
95013003	72	134	144	10

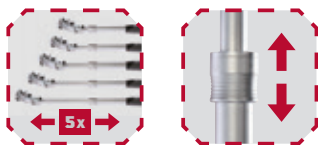

9511

6,3 1/4"

TELESKOP-HEBELUMSCHALTKNARRE, DIN 3122 D
 EXTENDABLE REVERSIBLE RATCHET, LEVER TYPE, DIN 3122 D

DIN 3120 A, ISO 1174-1, ISO 3315
 Chrom-Vanadium Stahl
 verchromt
 mit Feststellfunktion
 2-Komponentenheft

DIN 3120 A, ISO 1174-1, ISO 3315
 Chrome-Vanadium steel
 chrome plated
 with caps lock
 two component handle

Art.-No.		l-mm-l		
95014003	72	175-225	230	10



9520

STECKSCHLÜSSEL-GARNITUR SOCKET SET

Chrom-Vanadium Stahl
verchromt
33-tlg.
im Stahlblechkasten

1/4" Steckschlüssel-Einsatz, 6-kant 4 | 4,5 | 5 | 5,5 | 6 | 7 | 8 | 9 | 10 |
11 | 12 | 13 | 14 mm
1/4" Innensechskant-Schraubendreher-Einsatz 3 | 4 | 5 | 6 | 7 | 8 mm
1/4" TX Schraubendreher-Einsatz TX10 | TX15 | TX20 | TX25 | TX27 |
TX30 | TX40
1/4" Kardan-Gelenk
1/4" Verlängerung 50 | 100 mm
1/4" Griff mit Gleitstück
1/4" Steckgriff mit 1/4" Antriebsvierkant
1/4" Gelenk-Hebelumschaltknarre, 72 Zähne 140 mm
1/4" Maschinen-Adapter 30 mm



Chrome-Vanadium steel
chrome plated
33 pcs.
in metal box

1/4" Socket, 6-point 4 | 4,5 | 5 | 5,5 | 6 | 7 | 8 | 9 | 10 |
11 | 12 | 13 | 14 mm
1/4" Inside Hexagon Screwdriver Socket 3 | 4 | 5 | 6 | 7 | 8 mm
1/4" TX Screwdriver Socket TX10 | TX15 | TX20 | TX25 | TX27 |
TX30 | TX40
1/4" Universal Joint
1/4" Extension Bar 50 | 100 mm
1/4" Sliding T-Handle
1/4" Spinner Handle with 1/4" Square Coupler
1/4" Swivel Reversible Ratchet lever type, 72 teeth 140 mm
1/4" Machinery Adaptor 30 mm

Art.-No.	H x B x T (mm) H x W x L (mm)		
9520003	40 x 210 x 160	1522	1

Einzelteile entsprechen der DIN | parts according to DIN



9516

STECKSCHLÜSSEL-GARNITUR SOCKET SET

Chrom-Vanadium Stahl
verchromt
36-tlg.
im Stahlblechkasten

- 1/4" Steckschlüssel-Einsatz, 6-kant 4 | 4,5 | 5 | 5,5 | 6 | 6,5 | 7 | 8 | 9 | 10 | 11 | 12 | 13 mm
- 1/4" PH Schraubendreher-Einsatz PH1 | PH2
- 1/4" Schraubendreher-Einsatz 4 | 4,5 mm
- 1/4" Innensechskant-Schraubendreher-Einsatz 3 | 4 | 5 | 6 mm
- 1/4" TR Schraubendreher-Einsatz TR20 | TR25 | TR27 | TR30
- 1/4" Kardan-Gelenk
- 1/4" Verlängerung 50 | 100 mm
- 1/4" Griff mit Gleitstück
- 1/4" Steckgriff mit 1/4" Antriebsvierkant
- 1/4" Hebelumschaltknarre, 72 Zähne 140 mm
- Sechskant-Stiftschlüssel 1,25 | 1,5 | 2 | 2,5 | 3 mm



Chrome-Vanadium steel
chrome plated
36 pcs.
in metal box

- 1/4" Socket, 6-point 4 | 4,5 | 5 | 5,5 | 6 | 6,5 | 7 | 8 | 9 | 10 | 11 | 12 | 13 mm
- 1/4" PH Screwdriver Socket PH1 | PH2
- 1/4" Screwdriver Socket 4 | 4,5 mm
- 1/4" Inside Hexagon Screwdriver Socket 3 | 4 | 5 | 6 mm
- 1/4" TR Screwdriver Socket TR20 | TR25 | TR27 | TR30
- 1/4" Universal Joint
- 1/4" Extension Bar 50 | 100 mm
- 1/4" Sliding T-Handle
- 1/4" Spinner Handle with 1/4" Square Coupler
- 1/4" Reversible Ratchet lever type, 72 teeth 140 mm
- Hexagon Key Wrench 1,25 | 1,5 | 2 | 2,5 | 3 mm

Art.-No.	H x B x T (mm) H x W x L (mm)		
9267723	30 x 195 x 115	1310	1

Einzelteile entsprechen der DIN | parts according to DIN



9523

STECKSCHLÜSSEL-GARNITUR SOCKET SET

Chrom-Vanadium Stahl
verchromt
45-tlg.
im Stahlblechkasten

1/4" Steckschlüssel-Einsatz, 6-kant 4 | 4,5 | 5 | 5,5 | 6 | 7 | 8 | 9 | 10 |
11 | 12 | 13 mm
1/4" Kardan-Gelenk
1/4" Verlängerung 50 | 100 mm
1/4" Maschinen-Adapter 30 mm
1/4" Bit-Adapter
1/4" Teleskop-Umschaltknarre, 72 Zähne
Bit für Schlitzschrauben 5 | 7 mm
Bit für PH-Schrauben PH1 | 2 x PH2 | PH3
Bit für PZ-Schrauben PZ1 | 2 x PZ2 | PZ3
Bit für Innensechskant-Schrauben 2 | 2,5 | 3 | 4 | 5 | 6 | 8 mm
Bit für Innen-TORX®-Schrauben TX10 | 2 x TX15 | 2 x TX20 | 2 x TX25 |
TX27 | TX30 | TX40



Chrome-Vanadium steel
chrome plated
45 pcs.
in metal box

1/4" Socket, 6-point 4 | 4,5 | 5 | 5,5 | 6 | 7 | 8 | 9 | 10 |
11 | 12 | 13 mm
1/4" Universal Joint
1/4" Extension Bar 50 | 100 mm
1/4" Machinery Adaptor 30 mm
1/4" Bit Adaptor
1/4" Telescope Reversible Ratchet, 72 teeth
Bit for slotted screws 5 | 7 mm
Bit for PH screws PH1 | 2 x PH2 | PH3
Bit for PZ screws PZ1 | 2 x PZ2 | PZ3
Bit for inside hexagon screws 2 | 2,5 | 3 | 4 | 5 | 6 | 8 mm
Bit for inside TORX® screws TX10 | 2 x TX15 | 2 x TX20 | 2 x TX25 |
TX27 | TX30 | TX40

Art.-No.

H x B x T (mm)
H x W x L (mm)

9523003

45 x 300 x 200

1000

1

Einzelteile entsprechen der DIN | parts according to DIN



9515

STECKSCHLÜSSEL-GARNITUR SOCKET SET



Chrom-Vanadium Stahl
verchromt
47-tlg.
im Kunststoffkoffer

- 1/4" Steckschlüssel-Einsatz, 6-kant 4 | 4,5 | 5 | 5,5 | 6 | 7 | 8 | 9 | 10 | 11 | 12 | 13 | 14 mm
- 1/4" Steckschlüssel-Einsatz, lang 8 | 10 | 11 | 13 mm
- 1/4" PH Schraubendreher-Einsatz PH1 | PH2 | PH3
- 1/4" PZ Schraubendreher-Einsatz PZ1 | PZ2 | PZ3
- 1/4" Schraubendreher-Einsatz 4 | 5,5 | 6,5 mm
- 1/4" Innensechskant-Schraubendreher-Einsatz 3 | 4 | 5 | 6 | 7 | 8 mm
- 1/4" TX Schraubendreher-Einsatz TX10 | TX15 | TX20 | TX25 | TX30 | TX40
- 1/4" Kardan-Gelenk
- 1/4" Verlängerung 50 | 100 mm
- 1/4" Griff mit Gleitstück
- 1/4" Steckgriff mit 1/4" Antriebsvierkant
- 1/4" Hebelumschaltknarre, 72 Zähne 140 mm
- Sechskant-Stiftschlüssel 1,5 | 2 | 2,5 mm



Chrome-Vanadium steel
chrome plated
47 pcs.
in plastic case

- 1/4" Socket, 6-point 4 | 4,5 | 5 | 5,5 | 6 | 7 | 8 | 9 | 10 | 11 | 12 | 13 | 14 mm
- 1/4" Socket, 6-point long 8 | 10 | 11 | 13 mm
- 1/4" PH Screwdriver Socket PH1 | PH2 | PH3
- 1/4" PZ Screwdriver Socket PZ1 | PZ2 | PZ3
- 1/4" Screwdriver Socket 4 | 5,5 | 6,5 mm
- 1/4" Inside Hexagon Screwdriver Socket 3 | 4 | 5 | 6 | 7 | 8 mm
- 1/4" TX Screwdriver Socket TX10 | TX15 | TX20 | TX25 | TX30 | TX40
- 1/4" Universal Joint
- 1/4" Extension Bar 50 | 100 mm
- 1/4" Sliding T-Handle
- 1/4" Spinner Handle with 1/4" Square Coupler
- 1/4" Reversible Ratchet lever type, 72 teeth 140 mm
- Hexagon Key Wrench 1,5 | 2 | 2,5 mm

Art.-No.	H x B x T (mm) H x W x L (mm)		
9246793	40 x 160 x 230	1522	1

Einzelteile entsprechen der DIN | parts according to DIN



9521

STECKSCHLÜSSEL-GARNITUR SOCKET SET

Chrom-Vanadium Stahl
verchromt
53-tlg.
im Kunststoffkoffer

1/4" Steckschlüssel-Einsatz, 6-kant 4 | 4,5 | 5 | 5,5 | 6 | 7 | 8 | 9 | 10 | 11 | 12 | 13 | 14 mm
1/4" Steckschlüssel-Einsatz, 6-kant lang 6 | 7 | 8 | 9 | 10 | 12 | 13 mm
1/4" PH Schraubendreher-Einsatz PH1 | PH2 | PH3
1/4" PZ Schraubendreher-Einsatz PZ1 | PZ2 | PZ3
1/4" Schraubendreher-Einsatz 4 | 5,5 | 7 mm
1/4" Innensechskant-Schraubendreher-Einsatz 3 | 4 | 5 | 6 | 7 | 8 mm
1/4" TX Schraubendreher-Einsatz TX10 | TX15 | TX20 | TX25 | TX30 | TX40
1/4" Kardan-Gelenk
1/4" Verlängerung 50 | 100 mm
1/4" Flexible Verlängerung 150 mm
1/4" Griff mit Gleitstück
1/4" Bit-Adapter für 6-kant-Bits
1/4" Steckgriff mit 1/4" Antriebsvierkant
1/4" Hebelumschaltknarre, 72 Zähne 140 mm
Sechskant-Stiftschlüssel 1 | 1,5 | 2 | 2,5 mm



Chrome-Vanadium steel
chrome plated
53 pcs.
in plastic case

1/4" Socket, 6-point
4 | 4,5 | 5 | 5,5 | 6 | 7 | 8 | 9 | 10 | 11 | 12 | 13 | 14 mm
1/4" Socket, 6-point long 6 | 7 | 8 | 9 | 10 | 12 | 13 mm
1/4" PH Screwdriver Socket PH1 | PH2 | PH3
1/4" PZ Screwdriver Socket PZ1 | PZ2 | PZ3
1/4" Screwdriver Socket 4 | 5,5 | 7 mm
1/4" Inside Hexagon Screwdriver Socket 3 | 4 | 5 | 6 | 7 | 8 mm
1/4" TX Screwdriver Socket TX10 | TX15 | TX20 | TX25 | TX30 | TX40
1/4" Universal Joint
1/4" Extension Bar 50 | 100 mm
1/4" Flexible Extension 150 mm
1/4" Sliding T-Handle
1/4" Bit Adaptor for bits, 6-point
1/4" Spinner Handle with 1/4" Square Coupler
1/4" Reversible Ratchet lever type, 72 teeth 140 mm
Hexagon Key Wrench 1 | 1,5 | 2 | 2,5 mm

Art.-No.	H x B x T (mm) H x W x L (mm)		
9521003	50 x 300 x 280	1756	1

Einzelteile entsprechen der DIN | parts according to DIN



9901



STECKSCHLÜSSEL-EINSATZ, 6-KANT, DIN 3124
SOCKET, 6-POINT, DIN 3124

DIN 2725-1, DIN 3120 C,
ISO 1174-1
Chrom-Vanadium Stahl
verchromt

DIN 2725-1, DIN 3120 C,
ISO 1174-1
Chrome-Vanadium steel
chrome plated

Art.-No.	Ø mm	l mm-l	g	Box
99010603	6	28	20	10
99010703	7	28	21	10
99010803	8	28	21	10
99010903	9	28	22	10
99011003	10	28	23	10
99011103	11	28	25	10
99011203	12	28	24	10
99011303	13	28	27	10
99011403	14	28	29	10
99011503	15	28	37	10
99011603	16	28	34	10
99011703	17	28	44	10
99011803	18	30	58	10
99011903	19	30	58	10
99012003	20	30	65	10
99012103	21	30	63	10
99012203	22	30	63	10
99012403	24	30	95	10

9053



STECKSCHLÜSSEL-EINSATZ, 6-KANT, DIN 3124
SOCKET, 6-POINT, DIN 3124

DIN 2725-1, DIN 3120 C,
ISO 1174-1
Chrom-Vanadium Stahl
verchromt
lange Ausführung

DIN 2725-1, DIN 3120 C,
ISO 1174-1
Chrome-Vanadium steel
chrome plated
long type

Art.-No.	Ø mm	l mm-l	g	Box
9302533	17	63	97	10



9077



ZÜNDKERZEN-EINSATZ
SPARK PLUG SOCKET

DIN 3120-C, ISO 1174-1
Chrom-Vanadium Stahl
verchromt

DIN 3120-C, ISO 1174-1
Chrome-Vanadium steel
chrome plated

Art.-No.	Ø mm	l mm-l	g	Box
9294433	16	64	93	10
9294423	18	80	188	10
9294443	21	80	188	10



9078

E-TX SCHRAUBENDREHER-EINSATZ E-TX SCREWDRIVER SOCKET

DIN 3120 C, ISO 1174-1
für Außen-TORX®-Schrauben
Chrom-Vanadium Stahl
verchromt

DIN 3120 C, ISO 1174-1
for outside TORX®-screws
Chrome-Vanadium steel
chrome plated



Art.-No.		M	l-mm-l	g	
90780803	E 8	6	28	23	10
90781003	E 10	8	28	26	10
90781103	E 11	9	28	26	10
90781203	E 12	10	29	26	10
90781403	E 14	12	27	31	10



9076

SCHRAUBENDREHER-EINSATZ SCREWDRIVER SOCKET

**DIN 3120 C, DIN 5264,
DIN ISO 2380-1, ISO 1174-1**
für Schlitzschrauben
Chrom-Vanadium Stahl
verchromt

DIN 3120 C, DIN 5264,
DIN ISO 2380-1, ISO 1174-1
for slotted screws
Chrome-Vanadium steel
chrome plated



Art.-No.		l-mm-l	g	
907600803	8	45	53	10
907601003	10	45	54	10
907601203	12	45	55	10



9071

PZ SCHRAUBENDREHER-EINSATZ PZ SCREWDRIVER SOCKET

**DIN 3120 C, DIN ISO 8764-1,
ISO 1174-1**
für PZ-Kreuzschlitzschrauben
Chrom-Vanadium Stahl
verchromt

DIN 3120 C, DIN ISO 8764-1,
ISO 1174-1
for PZ screws
Chrome-Vanadium steel
chrome plated



Art.-No.		l-mm-l	g	
920710013	PZ 1	52	34	10
920710033	PZ 3	52	34	10



9070

PH SCHRAUBENDREHER-EINSATZ PH SCREWDRIVER SOCKET

**DIN 3120 C, DIN ISO 8764-1,
ISO 1174-1**
für PH-Kreuzschlitzschrauben
Chrom-Vanadium Stahl
verchromt

DIN 3120 C, DIN ISO 8764-1,
ISO 1174-1
for PH screws
Chrome-Vanadium steel
chrome plated



Art.-No.		l-mm-l	g	
90700013	PH 1	52	55	10
90700023	PH 2	52	55	10
90700033	PH 3	52	55	10
90700043	PH 4	52	56	10



9902

10 3/8"

INNENSECHSKANT-SCHRAUBENDREHER-EINSATZ, DIN 7422

INSIDE HEXAGON SCREWDRIVER SOCKET, DIN 7422

DIN 3120 C, ISO 1174-1
für Innensechskant-Schrauben
Chrom-Vanadium Stahl
verchromt

DIN 3120 C, ISO 1174-1
for inside hexagon screws
Chrome-Vanadium steel
chrome plated

Art.-No.		l-mm-l		
99020303	3	48	32	10
99020403	4	48	34	10
99020503	5	48	34	10
99020603	6	48	34	10
99020703	7	48	38	10
99020803	8	48	39	10
99021003	10	48	40	10

9232

10 3/8"

TX SCHRAUBENDREHER-EINSATZ, TX SCREWDRIVER SOCKET

DIN 3120 C, ISO 1174-1
für Innen-TORX®-Schrauben
Chrom-Vanadium Stahl
verchromt

DIN 3120 C, ISO 1174-1
for inside TORX® screws
Chrome-Vanadium steel
chrome plated

Art.-No.		l-mm-l		
92320103	TX 10	46	33	10
92320153	TX 15	46	33	10
92320203	TX 20	46	33	10
92320253	TX 25	46	33	10
92320273	TX 27	46	33	10
92320303	TX 30	46	34	10
92320403	TX 40	46	34	10
92320453	TX 45	46	37	10
92320503	TX 50	47	38	10
92320553	TX 55	48	45	10



9073

10 3/8"

ÜBERGANGSTEIL, DIN 3123 A ADAPTOR, DIN 3123 A

DIN 3120 A/C, ISO 1174-1, ISO 3316
Chrom-Vanadium Stahl
verchromt
3/8" innen, 1/2" außen

DIN 3120 A/C, ISO 1174-1, ISO 3316
Chrome-Vanadium steel
chrome plated
3/8" female, 1/2" male

Art.-No.	l-mm-l		
907303603	36	51	10

9074

10 3/8"

6,3 1/4"

ÜBERGANGSTEIL, DIN 3123 A ADAPTOR, DIN 3123 A

DIN 3120 A/C, ISO 1174-1, ISO 3316
Chrom-Vanadium Stahl
verchromt
3/8" innen, 1/4" außen

DIN 3120 A/C, ISO 1174-1, ISO 3316
Chrome-Vanadium steel
chrome plated
3/8" female, 1/4" male

Art.-No.	l-mm-l		
907402703	27	21	10





9903



VERLÄNGERUNG, DIN 3123 B
EXTENSION BAR, DIN 3123 B

DIN 3120 A/C, ISO 1174-1,
ISO 3316
Chrom-Vanadium Stahl
verchromt

DIN 3120 A/C, ISO 1174-1,
ISO 3316
Chrome-Vanadium steel
chrome plated

Art.-No.	l-mm-l		
99030403	40	53	10
9239743	75	75	10
9239753	125	122	10
99031503	150	143	10
9239763	250	235	10



9075



GRIF MIT GLEITSTÜCK, DIN 3122 A
SLIDING T-HANDLE, DIN 3122 A

DIN 3120 A/C, ISO 1174-1,
ISO 3315
Chrom-Vanadium Stahl
verchromt

DIN 3120 A/C, ISO 1174-1,
ISO 3315
Chrome-Vanadium steel
chrome plated

Art.-No.	l-mm-l		
907520003	200	160	10



9906



KARDAN-GELENK, DIN 3123 C
UNIVERSAL JOINT, DIN 3123 C

DIN 3120 A/C, ISO 1174-1,
ISO 3316
Chrom-Vanadium Stahl
verchromt

DIN 3120 A/C, ISO 1174-1,
ISO 3316
Chrome-Vanadium steel
chrome plated

Art.-No.	l-mm-l		
9239733	58	66	10



9907



HEBELUMSCHALTKNARRE, 72 ZÄHNE, DIN 3122 D
REVERSIBLE RATCHET, LEVER TYPE, 72 TEETH, DIN 3122 D

DIN 3120 A, ISO 1174-1, ISO 3315
Chrom-Vanadium Stahl
verchromt
2-Komponentenheft

DIN 3120 A, ISO 1174-1, ISO 3315
Chrome-Vanadium steel
chrome plated
two component handle

Art.-No.		l-mm-l		
9239513	72	200	255	5



9910

STECKSCHLÜSSEL-GARNITUR SOCKET SET

Chrom-Vanadium Stahl
verchromt
26-tlg.
im Kunststoffkoffer

3/8" Steckschlüssel-Einsatz, 6-kant 6 | 7 | 8 | 9 | 10 | 11 | 12 |
13 | 14 | 15 | 16 | 17 | 18 | 19 | 20 | 21 | 22 | 24 mm
3/8" Zündkerzeneinsatz 16 | 21 mm
3/8" Kardan-Gelenk
3/8" Verlängerung 40 | 75 | 150 mm
3/8" Adapter 1/2" x 3/8"
3/8" Hebelumschaltknarre, 72 Zähne 190 mm



Chrome-Vanadium steel
chrome plated
26 pcs.
in plastic case

3/8" Socket, 6-point 6 | 7 | 8 | 9 | 10 | 11 | 12 |
13 | 14 | 15 | 16 | 17 | 18 | 19 | 20 | 21 | 22 | 24 mm
3/8" Spark Plug Socket 16 | 21 mm
3/8" Universal Joint
3/8" Extension Bar 40 | 75 | 150 mm
3/8" Adaptor 1/2" x 3/8"
3/8" Reversible Ratchet lever type, 72 teeth 190 mm

Art.-No.

H x B x T (mm)
H x W x L (mm)

9235853

65 x 320 x 245

2256

1

Einzelteile entsprechen der DIN | parts according to DIN



9360

12,5 1/2"

STECKSCHLÜSSEL-EINSATZ, 6-KANT, DIN 3124
SOCKET, 6-POINT, DIN 3124

DIN 2725-1, DIN 3120 C,
ISO 1174-1
Chrom-Vanadium Stahl
verchromt

DIN 2725-1, DIN 3120 C,
ISO 1174-1
Chrome-Vanadium steel
chrome plated

Art.-No.	Ø mm	l mm	g	
93600803	8	38	48	10
93600903	9	38	48	10
93601003	10	38	49	10
93601103	11	38	50	10
93601203	12	38	50	10
93601303	13	38	52	10
93601403	14	38	54	10
93601503	15	38	56	10
93601603	16	38	50	10
93601703	17	38	64	10
93601803	18	38	76	10
93601903	19	38	66	10
93602003	20	38	78	10
93602103	21	38	73	10
93602203	22	39	82	10
93602303	23	38	94	10
93602403	24	38	108	10
93602503	25	42	142	10
93602603	26	42	132	10
93602703	27	42	159	10
93602803	28	42	169	10
93602903	29	42	170	10
93603003	30	42	199	10
93603203	32	43	219	10
93603603	36	45	310	5

9350

12,5 1/2"

STECKSCHLÜSSEL-EINSATZ, 12-KANT, DIN 3124
SOCKET, 12-POINT, DIN 3124

DIN 2725-1, DIN 3120 C,
ISO 1174-1
Chrom-Vanadium Stahl
verchromt

DIN 2725-1, DIN 3120 C,
ISO 1174-1
Chrome-Vanadium steel
chrome plated

Art.-No.	Ø mm	l mm	g	
93500803	8	38	46	10
93500903	9	38	48	10
93501003	10	39	48	10
93501103	11	40	49	10
93501203	12	38	50	10
93501303	13	38	51	10
93501403	14	38	52	10
93501503	15	38	56	10
93501603	16	38	56	10
93501703	17	38	60	10
93501803	18	38	74	10
93501903	19	38	62	10
93502003	20	38	76	10
93502103	21	38	76	10
93502203	22	39	90	10
93502403	24	38	120	10
93502703	27	43	158	10
93503003	30	42	184	10
93503203	32	44	204	10



9369

12,5 1/2"

STECKSCHLÜSSEL-EINSATZ, 6-KANT, DIN 3124
SOCKET, 6-POINT, DIN 3124

DIN 2725-1, DIN 3120 C,
ISO 1174-1
lange Ausführung
Chrom-Vanadium Stahl
verchromt

DIN 2725-1, DIN 3120 C,
ISO 1174-1
long type
Chrome-Vanadium steel
chrome plated

Art.-No.	Ø mm	l mm	g	
93691003	10	77	102	10
93691103	11	77	101	10
93691203	12	77	107	10
93691303	13	77	118	10
93691403	14	77	112	10
93691503	15	77	128	10
93691603	16	77	128	10
93691703	17	77	130	10
93691803	18	77	164	10
93691903	19	77	154	10
93692103	21	77	185	10
93692203	22	77	225	10
93692403	24	77	225	10



9361

12,5 1/2" ⊖

SCHRAUBENDREHER-EINSATZ
SCREWDRIVER SOCKET

**DIN 3120 C, DIN 5264,
DIN ISO 2380-1, ISO 1174-1**
für Schlitzschrauben
Chrom-Vanadium Stahl | verchromt

DIN 3120 C, DIN 5264,
DIN ISO 2380-1, ISO 1174-1
for slotted screws
Chrome-Vanadium steel | chrome
plated

Art.-No.	⊖	l-mm-l	g	☐
93610803	8	53	76	10
93611003	10	53	78	10
93611203	12	52	80	10



9362

12,5 1/2" ⊕

PH SCHRAUBENDREHER-EINSATZ
PH SCREWDRIVER SOCKET

**DIN 3120 C, DIN ISO 8764-1,
ISO 1174-1**
für PH-Kreuzschlitzschrauben
Chrom-Vanadium Stahl | verchromt

DIN 3120 C, DIN ISO 8764-1,
ISO 1174-1
for PH screws
Chrome-Vanadium steel | chrome
plated

Art.-No.	⊕	l-mm-l	g	☐
93620203	PH 2	60	80	10



9363

12,5 1/2" ⊙

**INNENSECHSKANT-SCHRAUBENDREHER-EINSATZ,
DIN 7422**

INSIDE HEXAGON SCREWDRIVER SOCKET, DIN 7422

DIN 3120 C, ISO 1174-1
für Innensechskant-Schrauben
Chrom-Vanadium Stahl
verchromt

DIN 3120 C, ISO 1174-1
for inside hexagon screws
Chrome Vanadium steel
chrome plated

Art.-No.	⊙mm	l-mm-l	g	☐
93630403	4	55	74	10
93630503	5	55	68	10
93630513	5	100	102	10
93630603	6	55	68	10
93630613	6	100	102	10
93630703	7	55	68	10
93630713	7	100	106	10
93630803	8	55	70	10
93630813	8	100	106	10
93631003	10	55	74	10
93631013	10	100	110	10
93631203	12	55	84	10
93631403	14	55	110	10
93631703	17	55	154	10
93631903	19	55	162	10



9357

12,5 1/2" ⊛

TX SCHRAUBENDREHER-EINSATZ
TX SCREWDRIVER SOCKET

DIN 3120 C, ISO 1174-1
für Innen-TORX®-Schrauben
Chrom-Vanadium Stahl
verchromt

DIN 3120 C, ISO 1174-1
for inside TORX® screws
Chrome-Vanadium steel
chrome plated

Art.-No.	⊛mm	M	l-mm-l	g	☐
93572003	TX20	4-5	55	73	10
93572013	TX 20	4-5	100	102	10
93572503	TX 25	4,5-5	55	84	10
93572513	TX 25	4,5-5	100	102	10
93572703	TX 27	4,5-6	55	84	10
93573003	TX 30	6-7	55	66	10
93573013	TX 30	6-7	100	102	10
93574003	TX 40	7-8	55	68	10
93574013	TX 40	7-8	100	102	10
93574503	TX 45	8-10	55	69	10
93574513	TX 45	8-10	100	104	10
93575003	TX 50	10	55	70	10
93575013	TX 50	10	100	106	10
93575503	TX 55	12	55	72	10
93575513	TX 55	12	100	106	10
93576003	TX 60	14	55	82	10
93576013	TX 60	14	100	122	10
93577003	TX 70	16	55	109	10



9349



XZN SCHRAUBENDREHER-EINSATZ
XZN SCREWDRIVER SOCKET

DIN 3120 C, ISO 1174-1
für XZN-Schrauben
Chrom-Vanadium Stahl
verchromt

DIN 3120 C, ISO 1174-1
for XZN screws
Chrome-Vanadium steel
chrome plated

Art.-No.	mm	l-mm-l	g	
93490053	5	52	64	10
93490063	6	55	74	10
93491063	6	100	116	10
93490083	8	55	75	10
93491083	8	100	104	10
93490103	10	55	76	10
93491103	10	100	106	10
93490123	12	55	86	10
93491123	12	100	130	10
93490143	14	55	92	10
93491143	14	100	150	10
93490163	16	55	94	10

9365



E-TX SCHRAUBENDREHER-EINSATZ
E-TX SCREWDRIVER SOCKET

DIN 3120 C, ISO 1174-1
für Außen-TORX[®]-Schrauben
Chrom-Vanadium Stahl
verchromt

DIN 3120 C, ISO 1174-1
for outside TORX[®] screws
Chrome-Vanadium steel
chrome plated

Art.-No.		M	l-mm-l	g	
93651003	E10	8	38	50	10
93651203	E12	10	38	55	10
93651403	E14	12	38	60	10
93651603	E16	12	38	52	10
93651803	E18	14	38	53	10
93652003	E20	16	38	54	10
93652203	E22	16-18	38	56	10
93652403	E24	18-20	40	122	10



9389



ZÜNDKERZEN-EINSATZ
SPARK PLUG SOCKET

DIN 3120 C, ISO 1174-1
Chrom-Vanadium Stahl
verchromt
mit Gummihalter

DIN 3120 C, ISO 1174-1
Chrome-Vanadium steel
chrome plated
with rubber insert

Art.-No.	mm	l-mm-l	g	
9239353	16	65	92	5
9239363	21	65	136	5



9352



KARDAN-GELENK, DIN 3123 C
UNIVERSAL JOINT, DIN 3123 C

DIN 3120 A/C, ISO 1174-1,
ISO 3316
Chrom-Vanadium Stahl
verchromt

DIN 3120 A/C, ISO 1174-1,
ISO 3316
Chrom-Vanadium steel
chrome plated

Art.-No.	l-mm-l		
9218073	73	160	10

9051



BIT-ADAPTER, DIN 3126
BIT ADAPTOR, DIN 3126

DIN 3120 C, DIN 3126,
ISO 1173, ISO 1174-1
Chrom-Vanadium Stahl
verchromt
mit Haltefeder für Bitaufnahme

DIN 3120 C, DIN 3126,
ISO 1173, ISO 1174-1
Chrom-Vanadium steel
chrome plated
with retaining spring for bit use

Art.-No.			l-mm-l		
9297123	1/2"	5/16"	36	56	10



9354



GRIF MIT GLEITSTÜCK, DIN 3122 A
SLIDING T-HANDLE, DIN 3122 A

DIN 3120 A/C, ISO 1174-1,
ISO 3315
Chrom-Vanadium Stahl
verchromt

DIN 3120 A/C, ISO 1174-1,
ISO 3315
Chrom-Vanadium steel
chrome plated

Art.-No.	l-mm-l		
9222573	300	421	10

9355



VERLÄNGERUNG, DIN 3123 B
EXTENSION BAR, DIN 3123 B

DIN 3120 A/C, ISO 1174-1,
ISO 3316
Chrom-Vanadium Stahl
verchromt

DIN 3120 A/C, ISO 1174-1,
ISO 3316
Chrom-Vanadium steel
chrome plated

Art.-No.	l-mm-l		
93550753	75	123	10
9211113	125	198	10
9222563	250	387	10



9366

12,5 1/2"

HEBELUMSCHALTKNARRE, 72 ZÄHNE, DIN 3122 D
 REVERSIBLE RATCHET, LEVER TYPE, 72 TEETH, DIN 3122 D

DIN 3120 A, ISO 1174-1, ISO 3315	DIN 3120 A, ISO 1174-1, ISO 3315
Chrom-Vanadium Stahl	Chrome-Vanadium steel
verchromt	chrome plated
2-Komponentenheft	two component handle

Art.-No.		l-mm-l		
9239313	72	260	438	5



9382

STECKSCHLÜSSEL-GARNITUR SOCKET SET

Chrom-Vanadium Stahl
verchromt
19-tlg.
im Stahlblechkasten

1/2" Steckschlüssel-Einsatz, 6-kant 10 | 11 | 12 | 13 | 14 | 15 |
16 | 17 | 19 | 22 | 24 | 27 | 30 | 32 mm
1/2" Kardan-Gelenk
1/2" Verlängerung 125 | 250 mm
1/2" Griff mit Gleitstück
1/2" Hebelumschaltknarre, 72 Zähne 250 mm



Chrome-Vanadium steel
chrome plated
19 pcs.
in metal box

1/2" Socket, 6-point 10 | 11 | 12 | 13 | 14 | 15 |
16 | 17 | 19 | 22 | 24 | 27 | 30 | 32 mm
1/2" Universal Joint
1/2" Extension Bar 125 | 250 mm
1/2" Sliding T-Handle
1/2" Reversible Ratchet lever type, 72 teeth 250 mm

Art.-No.

H x B x T (mm)
H x W x L (mm)

9247803

50 x 430 x 145

3600

1

Einzelteile entsprechen der DIN | parts according to DIN



9381

STECKSCHLÜSSEL-GARNITUR SOCKET SET



Chrom-Vanadium Stahl
verchromt
32-tlg.
im Kunststoffkoffer

- 1/2" Steckschlüssel-Einsatz, 6-kant 8 | 9 | 10 | 11 | 12 | 13 | 14 | 15 | 16 | 17 | 18 | 19 | 20 | 21 | 22 | 24 | 27 | 30 | 32 mm
- 1/2" Steckschlüssel-Einsatz, 12-kant 10 | 12 | 14 | 15 | 17 | 19 mm
- 1/2" Zündkerzen-Einsatz 16 | 21 mm
- 1/2" Kardan-Gelenk
- 1/2" Verlängerung 125 | 250 mm
- 1/2" Adapter-Gleitsstück 3/8" x 1/2"
- 1/2" Hebelumschaltknarre, 72 Zähne 250 mm



Chrome-Vanadium steel
chrome plated
32 pcs.
in plastic case

- 1/2" Socket, 6-point 8 | 9 | 10 | 11 | 12 | 13 | 14 | 15 | 16 | 17 | 18 | 19 | 20 | 21 | 22 | 24 | 27 | 30 | 32 mm
- 1/2" Socket, 12-point 10 | 12 | 14 | 15 | 17 | 19 mm
- 1/2" Spark Plug Socket 16 | 21 mm
- 1/2" Universal Joint
- 1/2" Extension Bar 125 | 250 mm
- 1/2" Sliding T-Adaptor 3/8" x 1/2"
- 1/2" Reversible Ratchet lever type, 72 teeth 250 mm

Art.-No.	H x B x T (mm) H x W x L (mm)		
9381003	80 x 320 x 280	4000	1

Einzelteile entsprechen der DIN | parts according to DIN



9384

STECKSCHLÜSSEL-GARNITUR SOCKET SET

Chrom-Vanadium Stahl
verchromt
54-tlg.
im Stahlblechkasten

1/4" Steckschlüssel-Einsatz, 6-kant 4 | 4,5 | 5 | 5,5 | 6 | 7 | 8 |
9 | 10 | 11 | 12 | 13 mm
1/4" PZ Schraubendreher-Einsatz PZ1 | PZ2
1/4" Schraubendreher-Einsatz 4 | 5,5 mm
1/4" Innensechskant-Schraubendreher-Einsatz 3 | 4 | 5 | 6 mm
1/4" TX Schraubendreher-Einsatz TX20 | TX25 | TX27 | TX30
1/4" Kardan-Gelenk
1/4" Verlängerung 50 | 150 mm
1/4" Griff mit Gleitstück
1/4" Steckgriff mit 1/4" Antriebsvierkant
1/4" Hebelumschaltknarre, 72 Zähne 140 mm
1/2" Steckschlüssel-Einsatz, 6-kant 10 | 11 | 12 | 13 | 14 | 15 | 17 |
19 | 22 | 24 | 27 | 30 | 32 mm
1/2" Zündkerzen-Einsatz 16 | 21 mm
1/2" Kardan-Gelenk
1/2" Verlängerung 75 | 250 mm
1/2" Griff mit Gleitstück
1/2" Hebelumschaltknarre, 72 Zähne 250 mm
Sechskant-Stiftschlüssel 1 | 1,5 | 2 | 2,5 mm



Chrome-Vanadium steel
chrome plated
54 pcs.
in metal box

1/4" Socket, 6-point 4 | 4,5 | 5 | 5,5 | 6 | 7 | 8 |
9 | 10 | 11 | 12 | 13 mm
1/4" PZ Screwdriver Socket PZ1 | PZ2
1/4" Screwdriver Socket 4 | 5,5 mm
1/4" Inside Hexagon Screwdriver Socket 3 | 4 | 5 | 6 mm
1/4" TX Screwdriver Socket TX20 | TX25 | TX27 | TX30
1/4" Universal Joint
1/4" Extension Bar 50 | 150 mm
1/4" Sliding T-Handle
1/4" Spinner Handle with 1/4" Square Coupler
1/4" Reversible Ratchet lever type, 72 teeth 140 mm
1/2" Socket, 6-point 10 | 11 | 12 | 13 | 14 | 15 | 17 |
19 | 22 | 24 | 27 | 30 | 32 mm
1/2" Spark Plug Socket 16 | 21 mm
1/2" Universal Joint
1/2" Extension Bar 75 | 250 mm
1/2" Sliding T-Handle
1/2" Reversible Ratchet lever, 72 teeth type 250 mm
Hexagon Key Wrench 1 | 1,5 | 2 | 2,5 mm

Art.-No.

H x B x T (mm)
H x W x L (mm)

9241913

52 x 450 x 200

5164

1

Einzelteile entsprechen der DIN | parts according to DIN



9385

STECKSCHLÜSSEL-GARNITUR SOCKET SET

Chrom-Vanadium Stahl | verchromt | 70-tlg. | im Aluminiumkoffer

- 1/4" Steckschlüssel-Einsatz, 6-kant 4 | 4,5 | 5 | 5,5 | 6 | 7 | 8 | 9 | 10 | 11 | 12 | 13 | 14 mm
- 1/4" Steckschlüssel-Einsatz, 6-kant lang 8 | 10 | 13 mm
- 1/4" PH Schraubendreher-Einsatz PH1 | PH2
- 1/4" PZ Schraubendreher-Einsatz PZ1 | PZ2
- 1/4" Schraubendreher-Einsatz 4 | 5,5 | 7 mm
- 1/4" Innensechskant-Schraubendreher-Einsatz 3 | 4 | 5 | 6 | 7 | 8 mm
- 1/4" TX Schraubendreher-Einsatz TX10 | TX15 | TX20 | TX25 | TX30 | TX40
- 1/4" Kardan-Gelenk
- 1/4" Verlängerung 50 | 100 mm
- 1/4" Griff mit Gleitstück
- 1/4" Steckgriff mit 1/4" Antriebsvierkant
- 1/4" Hebelumschaltknarre, 72 Zähne 140 mm
- 1/2" Steckschlüssel-Einsatz, 6-kant 15 | 16 | 17 | 18 | 19 | 20 | 21 | 22 | 24 | 27 | 30 | 32 mm
- 1/2" Steckschlüssel-Einsatz, 6-kant, lang 17 | 19 mm
- 1/2" Kardan-Gelenk
- 1/2" Verlängerung 125 | 250 mm
- 1/2" Adapter 3/8" x 1/2"
- 1/2" Hebelumschaltknarre, 72 Zähne 250 mm
- Ringmaulschlüssel 8 | 10 | 12 | 13 | 14 | 17 | 19 mm
- Sechskant-Stiftschlüssel 1,5 | 2 | 2,5 mm

6,3 1/4" 12,5 1/2"



Chrome-Vanadium steel | chrome plated | 70 pcs. | in aluminium case

- 1/4" Socket, 6-point 4 | 4,5 | 5 | 5,5 | 6 | 7 | 8 | 9 | 10 | 11 | 12 | 13 | 14 mm
- 1/4" Socket, 6-point long 8 | 10 | 13 mm
- 1/4" PH Screwdriver Socket PH1 | PH2
- 1/4" PZ Screwdriver Socket PZ1 | PZ2
- 1/4" Screwdriver Socket 4 | 5,5 | 7 mm
- 1/4" Inside Hexagon Screwdriver Socket 3 | 4 | 5 | 6 | 7 | 8 mm
- 1/4" TX Screwdriver Socket TX10 | TX15 | TX20 | TX25 | TX30 | TX40
- 1/4" Universal Joint
- 1/4" Extension Bar 50 | 100 mm
- 1/4" Sliding T-Handle
- 1/4" Spinner Handle with 1/4" Square Coupler
- 1/4" Reversible Ratchet lever type, 72 teeth 140 mm
- 1/2" Socket, 6-point 15 | 16 | 17 | 18 | 19 | 20 | 21 | 22 | 24 | 27 | 30 | 32 mm
- 1/2" Socket, 6-point, long 17 | 19 mm
- 1/2" Universal Joint
- 1/2" Extension Bar 125 | 250 mm
- 1/2" Adaptor 3/8" x 1/2"
- 1/2" Reversible Ratchet lever type, 72 teeth 250 mm
- Combination Spanner 8 | 10 | 12 | 13 | 14 | 17 | 19 mm
- Hexagon Key Wrench 1,5 | 2 | 2,5 mm

Art.-No.	H x B x T (mm) H x W x L (mm)		
9282413	95 x 435 x 325	6616	1

Einzelteile entsprechen der DIN | parts according to DIN



9387

STECKSCHLÜSSEL-GARNITUR SOCKET SET

Chrom-Vanadium Stahl | verchromt | 82-tlg. | im Kunststoffkoffer

1/4" Steckschlüssel-Einsatz, 6-kant 4 | 4,5 | 5 | 5,5 | 6 | 7 | 8 | 9 | 10 | 11 | 12 | 13 | 14 mm
 1/4" PH Schraubendreher-Einsatz PH1 | PH2
 1/4" PZ Schraubendreher-Einsatz PZ1 | PZ2
 1/4" Schraubendreher-Einsatz 4 | 5,5 | 7 mm
 1/4" Innensechskant-Schraubendreher-Einsatz 3 | 4 | 5 | 6 mm
 1/4" TX Schraubendreher-Einsatz TX8 | TX10 | TX15 | TX20 | TX25 | TX30
 1/4" Kardan-Gelenk
 1/4" Verlängerung 50 | 100 mm
 1/4" Flexible Verlängerung 150 mm
 1/4" Griff mit Gleitstück
 1/4" Steckgriff mit 1/4" Antriebsvierkant
 1/4" Hebelumschaltknarre, 72 Zähne 140 mm
 1/2" Steckschlüssel-Einsatz, 6-kant 14 | 15 | 16 | 17 | 18 | 19 | 20 | 22 | 23 | 24 | 27 | 30 | 32 mm
 1/2" Zündkerzen-Einsatz 16 | 21 mm
 1/2" Kardan-Gelenk
 1/2" Verlängerung 125 | 250 mm
 1/2" Adapter 3/8" x 1/2"
 1/2" Hebelumschaltknarre, 72 Zähne 250 mm
 1/2" Bit-Adapter für 6-kant-Bits
 Bit für PH-Schrauben PH3 | PH4
 Bit für PZ-Schrauben PZ3 | PZ4
 Bit für Schlitzschrauben 8 | 10 | 12 mm
 Bit für Innensechskant-Schrauben 8 | 10 | 12 | 14 mm
 Bit für Innen-TORX®-Schrauben TX40 | TX45 | TX50 | TX55
 Ringmaulschlüssel 8 | 10 | 11 | 12 | 13 | 14 | 17 | 19 | 22 mm

6,3 1/4" 12,5 1/2"



Chrome-Vanadium steel | chrome plated | 82 pcs. | in plastic case

1/4" Socket, 6-point 4 | 4,5 | 5 | 5,5 | 6 | 7 | 8 | 9 | 10 | 11 | 12 | 13 | 14 mm
 1/4" PH Screwdriver Socket PH1 | PH2
 1/4" PZ Screwdriver Socket PZ1 | PZ2
 1/4" Screwdriver Socket 4 | 5,5 | 7 mm
 1/4" Inside Hexagon Screwdriver Socket 3 | 4 | 5 | 6 mm
 1/4" TX Screwdriver Socket TX8 | TX10 | TX15 | TX20 | TX25 | TX30
 1/4" Universal Joint
 1/4" Extension Bar 50 | 100 mm
 1/4" Flexible Extension 150 mm
 1/4" Sliding T-Handle
 1/4" Spinner Handle with 1/4" Square Coupler
 1/4" Reversible Ratchet lever type, 72 teeth 140 mm
 1/2" Socket, 6-point 14 | 15 | 16 | 17 | 18 | 19 | 20 | 22 | 23 | 24 | 27 | 30 | 32 mm
 1/2" Spark Plug Socket 16 | 21 mm
 1/2" Universal Joint
 1/2" Extension Bar 125 | 250 mm
 1/2" Adaptor 3/8" x 1/2"
 1/2" Reversible Ratchet lever type, 72 teeth 250 mm
 1/2" Bit Adaptor for bits, 6-point
 Bit for PH screws PH3 | PH4
 Bit for PZ screws PZ3 | PZ4
 Bit for slotted screws 8 | 10 | 12 mm
 Bit for inside hexagon screws 8 | 10 | 12 | 14 mm
 Bit for inside TORX® screws TX40 | TX45 | TX50 | TX55
 Combination Spanner 8 | 10 | 11 | 12 | 13 | 14 | 17 | 19 | 22 mm

Art.-No.	H x B x T (mm) H x W x L (mm)		
9259010	65 x 330 x 200	6040	1

Einzelteile entsprechen der DIN | parts according to DIN



9386

STECKSCHLÜSSEL-GARNITUR SOCKET SET

Chrom-Vanadium Stahl | verchromt | 94-tlg. | im Kunststoffkoffer

- 1/4" Steckschlüssel-Einsatz, 6-kant 4 | 4,5 | 5 | 5,5 | 6 | 7 | 8 | 9 | 10 | 11 | 12 | 13 | 14 mm
- 1/4" Steckschlüssel-Einsatz, 6-kant lang 6 | 7 | 8 | 9 | 10 | 11 | 12 | 13 mm
- 1/4" PH Schraubendreher-Einsatz PH1 | PH2
- 1/4" PZ Schraubendreher-Einsatz PZ1 | PZ2
- 1/4" Schraubendreher-Einsatz 4 | 5,5 | 7 mm
- 1/4" Innensechskant-Schraubendreher-Einsatz 3 | 4 | 5 | 6 mm
- 1/4" TX Schraubendreher-Einsatz TX8 | TX10 | TX15 | TX20 | TX25 | TX30
- 1/4" Kardan-Gelenk
- 1/4" Verlängerung 50 | 100 mm
- 1/4" Flexible Verlängerung 150 mm
- 1/4" Griff mit Gleitstück
- 1/4" Steckgriff mit 1/4" Antriebsvierkant
- 1/4" Hebelumschaltknarre, 72 Zähne 140 mm
- 1/2" Steckschlüssel-Einsatz, 6-kant 10 | 11 | 12 | 13 | 14 | 15 | 16 | 17 | 18 | 19 | 20 | 21 | 22 | 23 | 24 | 27 | 30 | 32 mm
- 1/2" Steckschlüssel-Einsatz, 6-kant lang 14 | 15 | 17 | 19 mm
- 1/2" Zündkerzen-Einsatz 16 | 21 mm
- 1/2" Kardan-Gelenk
- 1/2" Verlängerung 125 | 250 mm
- 1/2" Adapter 3/8" x 1/2"
- 1/2" Hebelumschaltknarre, 72 Zähne 250 mm
- 1/2" Bit-Adapter für 6-kant-Bits
- Bit für PH-Schrauben PH3 | PH4
- Bit für PZ-Schrauben PZ3 | PZ4
- Bit für Schlitzschrauben 8 | 10 | 12 mm
- Bit für Innensechskant-Schrauben 8 | 10 | 12 | 14 mm
- Bit für Innen-TORX®-Schrauben TX40 | TX45 | TX50 | TX55
- Sechskant-Stiftschlüssel 1,5 | 2 | 2,5 mm

6,3 1/4" 12,5 1/2"



Chrome-Vanadium steel | chrome plated | 94 pcs. | in plastic case

- 1/4" Socket, 6-point 4 | 4,5 | 5 | 5,5 | 6 | 7 | 8 | 9 | 10 | 11 | 12 | 13 | 14 mm
- 1/4" Socket, 6-point long 6 | 7 | 8 | 9 | 10 | 11 | 12 | 13 mm
- 1/4" PH Screwdriver Socket PH1 | PH2
- 1/4" PZ Screwdriver Socket PZ1 | PZ2
- 1/4" Screwdriver Socket 4 | 5,5 | 7 mm
- 1/4" Inside Hexagon Screwdriver Socket 3 | 4 | 5 | 6 mm
- 1/4" TX Screwdriver Socket TX8 | TX10 | TX15 | TX20 | TX25 | TX30
- 1/4" Universal Joint
- 1/4" Extension Bar 50 | 100 mm
- 1/4" Flexible Extension 150 mm
- 1/4" Sliding T-Handle
- 1/4" Spinner Handle with 1/4" Square Coupler
- 1/4" Reversible Ratchet lever type, 72 teeth 140 mm
- 1/2" Socket, 6-point 10 | 11 | 12 | 13 | 14 | 15 | 16 | 17 | 18 | 19 | 20 | 21 | 22 | 23 | 24 | 27 | 30 | 32 mm
- 1/2" Socket, 6-point long 14 | 15 | 17 | 19 mm
- 1/2" Spark Plug Socket 16 | 21 mm
- 1/2" Universal Joint
- 1/2" Extension Bar 125 | 250 mm
- 1/2" Adaptor 3/8" x 1/2"
- 1/2" Reversible Ratchet lever type, 72 teeth 250 mm
- 1/2" Bit Adaptor for bits, 6-point
- Bit for PH screws PH3 | PH4
- Bit for PZ screws PZ3 | PZ4
- Bit for slotted screws 8 | 10 | 12 mm
- Bit for inside hexagon screws 8 | 10 | 12 | 14 mm
- Bit for inside TORX® screws TX40 | TX45 | TX50 | TX55
- Hexagon Key Wrench 1,5 | 2 | 2,5 mm

Art.-No.	H x B x T (mm) H x W x L (mm)		
9255390	80 x 380 x 320	6300	1

Einzelteile entsprechen der DIN | parts according to DIN



9383

STECKSCHLÜSSEL-GARNITUR SOCKET SET

Chrom-Vanadium Stahl | verchromt | 171-tlg. | in Kunststoffkoffer

- 1/4" Steckschlüssel-Einsatz, 6-kant, lang 4 | 5 | 6 | 7 | 8 | 9 | 10 mm
- 1/4" E-TX Schraubendreher-Einsatz E4 | E5 | E6 | E7 | E8
- 1/4" PH Schraubendreher-Einsatz PH 0 | 1 | 2
- 1/4" PZ Schraubendreher-Einsatz 0 | 1 | 2
- 1/4" Schraubendreher-Einsatz 4 | 5,5 | 6,5 | 7 mm
- 1/4" Innensechskant-Schraubendreher-Einsatz 3 | 4 | 5 | 6 mm
- 1/4" TX Schraubendreher-Einsatz 8 | 9 | 10 | 15 | 20 | 25 | 27 | 30
- 1/4" TR Schraubendreher-Einsatz 8 | 9 | 10 | 15 | 20 | 25 | 27 | 30
- 1/4" Kardangelen
- 1/4" Verlängerung 50 mm | 100 mm
- 1/4" Griff mit Gleitstück 115 mm
- 1/4" Steckgriff 150 mm
- 1/4" Hebelumschaltknarre 72 Zähne 140 mm
- 3/8" Steckschlüssel-Einsatz, 6-kant 10 | 11 | 12 | 13 | 14 | 15 | 16 | 17 | 18 | 19 mm
- 3/8" Steckschlüssel-Einsatz, 6-kant, lang 10 | 11 | 12 | 13 | 14 | 15 mm
- 3/8" Zündkerzen-Einsatz 18 mm
- 3/8" E-TX Schraubendreher-Einsatz E10 | E11 | E12 | E14 | E16 | E18
- 3/8" Kardangelen
- 3/8" Verlängerung 150 mm
- 3/8" Bit Adapter 8 mm
- 3/8" Hebelumschaltknarre 72 Zähne 190 mm
- 1/2" Steckschlüssel-Einsatz, 6-kant 10 | 11 | 12 | 13 | 14 | 15 | 16 | 17 | 18 | 19 | 20 | 21 | 22 | 24 | 27 | 30 | 32 mm
- 1/2" Steckschlüssel-Einsatz, 6-kant, lang 16 | 17 | 18 | 19 | 22 mm
- 1/2" Zündkerzen-Einsatz 16 mm | 21 mm
- 1/2" E-TX Schraubendreher-Einsatz E20 | E24
- 1/2" Verlängerung 125 mm | 250 mm
- 1/2" Kardan-Gelenk
- 1/2" Gleitstück
- 1/2" Bit Adapter 10 mm
- 1/2" Hebelumschaltknarre 72 Zähne 250 mm
- Bit für TORX®-Schrauben TX10 | TX15 | TX 20 | TX 25 | TX 27 | TX 30 | TX 40 | TX 45 | TX 50 | TX 55 | TX 60 | TX 70
- Bit für Tamper-TORX®-Schrauben TR40 | TR45 | TR 50 | TR55 | TR60 | TR70
- Bit für PH-Schrauben 0 | 1 | 2 | 3 | 3 | 4
- Bit für PZ-Schrauben 1 | 2 | 3 | 3 | 4
- Bit für Schlitzschrauben 8 | 10 | 12 mm
- Bit für FD-Schlitzschrauben 6/8 | 8/10 | 8/10 | 10/12"
- Bit Kombi S 1 | 2 | 3
- Bit für Innensechskantschrauben 7 | 8 | 10 | 12 | 14 mm
- Sechskant-Stiftschlüssel 1,27 | 1,5 | 2 | 2,5 | 3 | 4 | 5 mm

6,3 1/4" 10 3/8" 12,5 1/2"



Chrome-Vanadium steel | chrome plated | 171 pcs. | in plastic case

- 1/4" Socket, 6-point, long 4 | 5 | 6 | 7 | 8 | 9 | 10 mm
- 1/4" E-TX Screwdriver Socket E4 | E5 | E6 | E7 | E8
- 1/4" PH Screwdriver Socket PH 0 | 1 | 2
- 1/4" PZ Screwdriver Socket 0 | 1 | 2
- 1/4" Screwdriver Socket 4 | 5,5 | 6,5 | 7 mm
- 1/4" Inside Hexagon Screwdriver Socket 3 | 4 | 5 | 6 mm
- 1/4" TX Screwdriver Socket 8 | 9 | 10 | 15 | 20 | 25 | 27 | 30
- 1/4" TR Screwdriver Socket 8 | 9 | 10 | 15 | 20 | 25 | 27 | 30
- 1/4" Universal Joint
- 1/4" Extension Bar 50 mm | 100 mm
- 1/4" Sliding T-handle 115 mm
- 1/4" Spinner Handle 150 mm
- 1/4" Reversible Ratchet lever type, 72 teeth 140 mm
- 3/8" Socket, 6-point 10 | 11 | 12 | 13 | 14 | 15 | 16 | 17 | 18 | 19 mm
- 3/8" Socket, 6-point, long 10 | 11 | 12 | 13 | 14 | 15 mm
- 3/8" Spark Plug Socket 18 mm
- 3/8" E-TX Screwdriver Socket E10 | E11 | E12 | E14 | E16 | E18
- 3/8" Universal Joint
- 3/8" Extension Bar 150 mm
- 3/8" Bit Adaptor 8 mm
- 3/8" Reversible Ratchet lever type, 72 teeth 190 mm
- 1/2" Socket, 6-point 10 | 11 | 12 | 13 | 14 | 15 | 16 | 17 | 18 | 19 | 20 | 21 | 22 | 24 | 27 | 30 | 32 mm
- 1/2" Socket, 6-point, long 16 | 17 | 18 | 19 | 22 mm
- 1/2" Spark Plug Socket 16 mm | 21 mm
- 1/2" E-TX Screwdriver Socket E20 | E24
- 1/2" Extension Bar 125 mm | 250 mm
- 1/2" Universal Joint
- 1/2" Sliding Adaptor
- 1/2" Bit Adaptor 10 mm
- 1/2" Reversible Ratchet lever type, 72 teeth 250 mm
- Bit for TORX® screws TX10 | TX15 | TX 20 | TX 25 | TX 27 | TX 30 | TX 40 | TX 45 | TX 50 | TX 55 | TX 60 | TX 70
- Bit for Tamper TORX® screws TR40 | TR45 | TR 50 | TR55 | TR60 | TR70
- Bit for PH screws 0 | 1 | 2 | 3 | 3 | 4
- Bit for PZ screws 1 | 2 | 3 | 3 | 4
- Bit for slotted screws 8 | 10 | 12 mm
- Bit for FD screws 6/8 | 8/10 | 8/10 | 10/12"
- Bit Kombi S 1 | 2 | 3
- Bit for inside hexagon screws 7 | 8 | 10 | 12 | 14 mm
- Hexagon Key Wrench 1,27 | 1,5 | 2 | 2,5 | 3 | 4 | 5 mm

Art.-No.	H x B x T (mm) H x W x L (mm)		
9301130	95 x 530 x 400	8866	1

Einzelteile entsprechen der DIN | parts according to DIN



9440



STECKSCHLÜSSEL-EINSATZ, 6-KANT, DIN 3124
SOCKET, 6-POINT, DIN 3124

DIN 3120 D, ISO 1174-1,
ISO 2725-1
Chrom-Vanadium Stahl
verchromt

DIN 3120 D, ISO 1174-1,
ISO 2725-1
Chrome-Vanadium steel
chrome plated

Art.-No.	Ø mm	l mm	g	Box
94401903	19	50	172	5
94402103	21	50	217	5
94402203	22	50	217	5
94402303	23	50	223	5
94402403	24	51	224	5
94402603	26	51	231	5
94402703	27	52	234	5
94402903	29	52	252	5
94403003	30	52	290	5
94403203	32	55	316	5
94403503	35	55	399	5
94403603	36	57	432	5
94403803	38	60	414	5
94404103	41	63	508	5
94404603	46	68	684	5
94405003	50	72	838	5



9443



VERLÄNGERUNG, DIN 3123 B
EXTENSION BAR, DIN 3123 B

DIN 3120 A/C, ISO 1174-1,
ISO 3316
Chrom-Vanadium Stahl
verchromt

DIN 3120 A/C, ISO 1174-1,
ISO 3316
Chrome-Vanadium steel
chrome plated

Art.-No.	l mm	g	Box
94431003	100	408	1
94432003	200	693	1
94434003	400	1319	1



9442



GRIF MIT GLEITSTÜCK, DIN 3122 A
SLIDING T-HANDLE, DIN 3122 A

DIN 3120 A/C, ISO 1174-1,
ISO 3315
Chrom-Vanadium Stahl
verchromt

DIN 3120 A/C, ISO 1174-1,
ISO 3315
Chrome-Vanadium steel
chrome plated

Art.-No.	l mm	g	Box
94424503	450	1391	10



9439



HEBELUMSCHALTKNARRE, 24 ZÄHNE, DIN 3122 D
REVERSIBLE RATCHET, LEVER TYPE 24 TEETH, DIN 3122 D

DIN 3120 A/C, ISO 1174-1,
ISO 3315
Chrom-Vanadium Stahl
verchromt

DIN 3120 A/C, ISO 1174-1,
ISO 3315
Chrome-Vanadium steel
chrome plated

Art.-No.	Teeth	l mm	g	Box
9272433	24	490	2650	1



9391

STECKSCHLÜSSEL-GARNITUR SOCKET SET



Chrom-Vanadium Stahl
verchromt
21-tlg.
im Kunststoffkoffer

3/4" Steckschlüssel-Einsatz, 6-kant 19 | 21 | 22 | 23 | 24 | 26 |
27 | 29 | 30 | 32 | 35 | 36 | 38 | 41 | 46 | 50 mm
3/4" Verlängerung 100 | 200 | 400 mm
3/4" Griff mit Gleitstück
3/4" Umschaltknarre 490 mm



Chrome-Vanadium steel
chrome plated
21 pcs.
in plastic case

3/4" Socket, 6-point 19 | 21 | 22 | 23 | 24 | 26 |
27 | 29 | 30 | 32 | 35 | 36 | 38 | 41 | 46 | 50 mm
3/4" Extension Bar 100 | 200 | 400 mm
3/4" Sliding T-Handle
3/4" Reversible Ratchet 490 mm

Art.-No.	H x B x T (mm) H x W x L (mm)		
9391003	95 x 530 x 400	14436	1

Einzelteile entsprechen der DIN | parts according to DIN

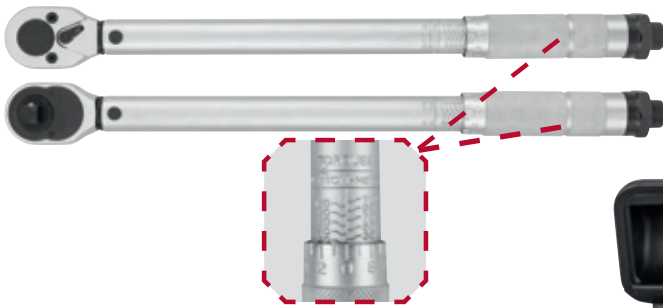

9239

AUTOMATISCHER DREHMOMENTSCHLÜSSEL AUTOMATIC TORQUE WRENCH

Chrom-Vanadium Stahl | verchromt
selbstausslösend
Rechtsanzug
Genauigkeit +/- 4% vom Skalenwert
(DIN ISO 6789:2003)
Doppelskala Nm / lbf.ft
Seriennummer und Zertifikat

Hebelumschaltknarre 24 Zähne

10 3/8" □

Chrome-Vanadium steel | chrome plated
self-releasing
clockwise operation
accuracy +/- 4% from scale value
(DIN ISO 6789:2003)
double-scale Nm / lbf.ft
serial number and certificate

Reversible Ratchet lever type 24 teeth

Art.-No.	□	Meßbereich (Nm) Range (Nm)	Meßbereich (lbs/ft) Range (lbs/ft)	Teilung (Nm) Scale split (Nm)	l-mm-l	g	□
9243260	3/8"	20-110	14,75-72,33	1	370	830	1



9373

AUTOMATISCHER DREHMOMENTSCHLÜSSEL IM SET AUTOMATIC TORQUE WRENCH SET

Chrom-Vanadium Stahl | verchromt
selbstausslösend
Rechtsanzug
Genauigkeit +/- 4% vom Skalenwert
(DIN ISO 6789:2003)
Doppelskala Nm / lbf.ft
Seriennummer und Zertifikat

Hebelumschaltknarre 24 Zähne
Steckschlüssel-Einsatz, 6-kant 17 | 19 | 21 mm
Verlängerung 125 mm

12,5 1/2" □ □ □

Chrome-Vanadium steel | chrome plated
self-releasing
clockwise operation
accuracy +/- 4% from scale value
(DIN ISO 6789:2003)
double-scale Nm / lbf.ft
serial number and certificate

Reversible Ratchet lever type 24 teeth
Socket, 6-point 17 | 19 | 21 mm
Extension Bar 125 mm

Art.-No.	□	Meßbereich (Nm) Range (Nm)	Meßbereich (lbs/ft) Range (lbs/ft)	Teilung (Nm) Scale split (Nm)	l-mm-l	g	□
93732100	1/2"	42-210	31-155	1,0	490	2200	1



93316 MK

KRAFT-EINSATZ-GARNITUR IMPACT SOCKET SET

Chrom-Molybdän Stahl
schwarz
15-tlg. + 2x Ring + 2x Stift
im Stahlblechkasten
mit Ring und Stift

12,5 1/2" 

Chrome-Molybdenum steel
black
15 pcs. + 2x ring + 2x pin
in metal box
with ring and pin

Art.-No.	 mm	H x B x T (mm) H x W x L (mm)		
933160001	10 11 12 13 14 15 16 17 18 19 21 22 24 27 30	50 x 435 x 95	3896	1

Einzelteile entsprechen der DIN | parts according to DIN





9920 KK

KRAFT-SCHONEINSATZ-GARNITUR, DIN 3129 PROTECTIVE IMPACT SOCKET SET, DIN 3129

lange Ausführung
Chrom-Molybdän Stahl
kunststoffummantelt
5-tlg.
in Kunststoffkassette

12,5 1/2" 

long type
Chrome-Molybdenum steel
plastic coated
5 pcs.
in plastic case

Art.-No.	Inhalt Content	H x B x T (mm) H x W x L (mm)		
99200000	15 17 19 21 22	45 x 195 x 140	1354	1



9530

WERKSTATT-SCHRAUBENDREHER, DIN ISO 2380
ENGINEERS SCREWDRIVER, DIN ISO 2380

für Schlitzschrauben
Chrom-Vanadium Stahl
verchromt mit schwarzer Spitze
2-Komponentenheft

for slotted screws
Chrome-Vanadium steel
chrome plated with black tip
two component handle



9535

PH SCHRAUBENDREHER, DIN ISO 8764
PH SCREWDRIVER, DIN ISO 8764

für PH-Kreuzschlitzschrauben
Chrom-Vanadium Stahl
verchromt mit schwarzer Spitze
2-Komponentenheft

for PH screws
Chrome-Vanadium steel
chrome plated with black tip
two component handle



Art.-No.	mm	mm	mm	l-mm-l	g	
95300300	3,0	75	0,5	158	28	10
95300400	4,0	80	0,8	164	34	10
95300550	5,5	125	1,0	223	64	10
95300650	6,5	150	1,2	257	94	10
95300800	8,0	150	1,2	267	148	10

Art.-No.		mm	l-mm-l	g	
95350000	PH0	75	158	27	10
95350100	PH1	80	180	58	10
95350200	PH2	100	210	82	10
95350300	PH3	150	267	146	10

9587 S

SCHRAUBENDREHER-SET, DIN ISO 2380, DIN ISO 8764
SCREWDRIVER SET, DIN ISO 2380, DIN ISO 8764

Chrom-Vanadium Stahl
verchromt mit schwarzer Spitze
2-Komponentenheft
9-tlg.
im Sichtkarton

Werkstattsschraubendreher
3,0 x 75 mm | 4,0 x 80 mm | 5,5 x 125 mm | 6,5 x 150 mm | 8,0 x 150 mm
PH Schraubendreher
PH0 x 75 mm | PH1 x 80 mm | PH2 x 100 mm | PH3 x 150 mm



Chrome-Vanadium steel
chrome plated with black tip
two component handle
9 pcs
in cardboard box

Engineers Screwdriver
3,0 x 75 mm | 4,0 x 80 mm | 5,5 x 125 mm | 6,5 x 150 mm | 8,0 x 150 mm
PH Screwdriver
PH0 x 75 mm | PH1 x 80 mm | PH2 x 100 mm | PH3 x 150 mm



Art.-No.	g	
95870003	840	1



9591



VDE SCHRAUBENDREHER, DIN ISO 2380
VDE SCREWDRIVER, DIN ISO 2380

für Schlitzschrauben
isoliert nach **DIN EN 60900**
(VDE 0682/201)
S2-Profi-Stahl
2-Komponentenheft
mit Aufhängeloch

for slotted screws
insulated according to DIN EN 60900
(VDE 0682/201)
S2 Professional steel
two component handle
with hanging hole

Art.-No.	mm	mm	l-mm-l	g	
95910250	2,5	80	160	20	10
95910300	3	75	145	21	10
95910350	3,5	100	170	26	10
95910400	4	100	185	50	10
95910550	5,5	125	230	84	10
95910650	6,5	150	260	108	10

9593



VDE PH SCHRAUBENDREHER, DIN ISO 8764
VDE PH SCREWDRIVER, DIN ISO 8764

für PH-Kreuzschlitzschrauben
isoliert nach **DIN EN 60900**
(VDE 0682/201)
S2-Profi-Stahl
2-Komponentenheft
mit Aufhängeloch

for PH screws
insulated according to DIN EN 60900
(VDE 0682/201)
S2 Professional steel
two component handle
with hanging hole

Art.-No.		mm	l-mm-l	g	
95930000	PH 0	75	145	22	10
95930010	PH 1	80	170	48	10
95930020	PH 2	100	205	86	10
95930030	PH 3	150	260	148	10

9594 S



VDE SCHRAUBENDREHER-SET, DIN ISO 2380, DIN ISO 8764
VDE SCREWDRIVER SET,
DIN ISO 2380, DIN ISO 8764

isoliert nach **DIN EN 60900**
(VDE 0682/201)
S2-Profi-Stahl
2-Komponentenheft
mit Aufhängeloch
7-tlg.
im Sichtkarton

insulated according to DIN EN 60900
(VDE 0682/201)
S2 Professional steel
two component handle
with hanging hole
7 pcs.
in display cardboard box

Inhalt Content	Klinge Blade	mm	mm
9591		2,5	80
9591		4,0	100
9591		5,5	125
9591		6,5	150
9591		PH1	80
9591		PH2	100
Spannungsprüfer Voltage tester		3,0	65

Art.-No.	H x B x T [mm] H x W x L [mm]	g	
95913003	275 x 135 x 35	502	1





9130

RATSCHENSCHRAUBENDREHER-GARNITUR SCREWDRIVER BIT SET

DIN ISO 1085, ISO 3318, ISO 10102

Chrom-Vanadium Stahl

verchromt

in schlagfester Kunststoffbox

58-tlg.

Bit-Halter mit 2-Komponentenheft, 180° schwenkbar,
45° Sicherheitsarretierung

Bit-Adapter

Bit für PH-Schrauben PH0 | PH1 | PH2 | PH3 } 2x

Bit für PZ-Schrauben PZ0 | PZ1 | PZ2 | PZ3 } 2x

Bit für Schlitzschrauben 3 | 4 | 4,5 | 5 | 6 | 7 | 8 mm

Bit für Innensechskant-Schrauben 1,5 | 2 | 2,5 | 3 | 4 | 5 | 6 mm

Bit für TORX®-Schrauben

TX5 | TX6 | TX7 | TX8 | TX9 | TX10 | TX15 | TX20 | TX25 | TX30 | TX40 } 2x

2x

Bit für XZN-Schrauben M4 | M5 | M6

Maschinen-Adapter magnetisch, mit Arretierungshilfe



DIN ISO 1085, ISO 3318, ISO 10102

Chrome-Vanadium steel

chrome plated

in shatterproof plastic box

58 pcs.

Bit Holder with two component handle, 180° swiveling,
45° safety locking mechanism

Bit Adaptor

Bit for PH screws PH0 | PH1 | PH2 | PH3 } 2x

Bit for PZ screws PZ0 | PZ1 | PZ2 | PZ3 } 2x

Bit for slotted screws 3 | 4 | 4,5 | 5 | 6 | 7 | 8 mm

Bit for inside hexagon screws 1,5 | 2 | 2,5 | 3 | 4 | 5 | 6 mm

Bit for TORX® screws

TX5 | TX6 | TX7 | TX8 | TX9 | TX10 | TX15 | TX20 | TX25 | TX30 | TX40 } 2x

Bit for XZN screws M4 | M5 | M6

magnetic Machinery Adaptor, with locking mechanism

Art.-No.

H x B x T (mm)
H x W x L (mm)



9282393

40 x 180 x 200

824

1





9845

KOMBINATIONSZANGE, DIN ISO 5746
COMBINATION PLIERS, DIN ISO 5746

Chrom-Vanadium Stahl
verchromt, poliert
2-Komponentengriffe

Chrome-Vanadium steel
chrome plated, polished
two component handle

Art.-No.	l-mm-l		
98451608	160	220	6
98451808	180	285	6
98452008	200	364	6



9870

SEITENSCHNEIDER, DIN ISO 5749
DIAGONAL CUTTERS, DIN ISO 5749

Chrom-Vanadium Stahl
verchromt, poliert
2-Komponentengriffe

Chrome-Vanadium steel
chrome plated, polished
two component handle

Art.-No.	l-mm-l		
98701608	160	221	6

9860

KRAFTSEITENSCHNEIDER, DIN ISO 5749
HEAVY DUTY DIAGONAL CUTTERS, DIN ISO 5749

Chrom-Vanadium Stahl
verchromt, poliert
2-Komponentengriffe

Chrome-Vanadium steel
chrome plated, polished
two component handle

Art.-No.	l-mm-l		
98601808	180	248	6





9890

FLACHRUNDZANGE, DIN ISO 5745
 SNIPE NOSE PLIERS, DIN ISO 5745

Chrom-Vanadium Stahl
 verchromt, poliert
 gerade Ausführung
 2-Komponentengriffe

Chrome-Vanadium steel
 chrome plated, polished
 straight pattern
 two component handle

Art.-No.	l-mm-l		
98902008	200	262	6



9891

FLACHRUNDZANGE, DIN ISO 5745
 SNIPE NOSE PLIERS, DIN ISO 5745

Chrom-Vanadium Stahl
 verchromt, poliert
 45° abgewinkelte Ausführung
 2-Komponentengriffe

Chrome-Vanadium steel
 chrome plated, polished
 45° bent pattern
 two component handle



Art.-No.	l-mm-l		
98911608	160	152	6
98912008	200	201	6

9882

ABISOLIERZANGE
 WIRE STRIPPING PLIERS

Chrom-Vanadium Stahl
 verchromt, poliert
 Messing-Einstellschraube und Feder
 2-Komponentengriffe

Chrome-Vanadium steel
 chrome plated, polished
 brass adjustment screw and spring
 two component handle

Art.-No.	l-mm-l		
98821608	160	192	6





9818

WASSERPUMPENZANGE, DIN ISO 8976 WATER PUMP PLIERS, DIN ISO 8976

Chrom-Vanadium Stahl
mit durchgestecktem Gleitgelenk
Rillenführung
2-Komponentengriffe

Chrome-Vanadium steel
with box joint
spline adjustment
two component handle

Art.-No.	l-mm-l		
98182403	250	620	6





9819

WASSERPUMPENZANGE, DIN ISO 8976 WATER PUMP PLIERS, DIN ISO 8976

Chrom-Vanadium Stahl
mit durchgestecktem Gleitgelenk
7-fach verstellbar

Chrome-Vanadium steel
with box joint
7 position adjustment

Art.-No.	l-mm-l		
98192400	240	370	6





9827

UNIVERSAL-GRIP-ZANGE UNIVERSAL GRIP PLIERS

**Spezial-Werkzeugstahl
vernickelt
mit Drahtabschneider
Einsatzbereich: rundes und
flaches Material**

Special Carbon steel
nickel plated
with wire cutter
application field: round and
flat material



Art.-No.	l-mm-l	 g	
98271806	180	326	6
98272256	225	570	6

9828

UNIVERSAL-GRIP-ZANGE UNIVERSAL GRIP PLIERS

**Spezial-Werkzeugstahl
vernickelt
mit Drahtabschneider
Einsatzbereich: rundes und
flaches Material**

Special Carbon steel
nickel plated
with wire cutter
application field: round and
flat material

Art.-No.	l-mm-l	 g	
9215283	140	150	5
9215303	180	360	5
9204283	250	570	5





9829

UNIVERSAL-GRIP-ZANGE UNIVERSAL GRIP PLIERS

**Chrom-Vanadium Stahl
vernickelt
mit Drahtabschneider
Einsatzbereich: rundes und
flaches Material**

Chrome-vanadium steel
nickel plated
with wire cutter
application field: round and
flat material

Art.-No.	l-mm-l	 g	
98291806	180	326	5
98292506	250	533	5
98293006	300	1115	3



9771

HENKELLOCHEISEN, DIN 7200 A
WAD PUNCH, DIN 7200 A

Spezialstahl gehärtet
pulverbeschichtet

Special steel hardened
powder coated

Art.-No.	∅ mm	∅ AF"	l mm-l	g	📦
97710040	4	5/32"	105	48	10
97710050	5	3/16"	110	55	10
97710060	6	7/32"	110	68	10
97710080	8	5/16"	120	97	10
97710100	10	3/8"	130	135	10
97710120	12	15/32"	130	135	10
97710140	14	9/16"	140	169	10
97710160	16	5/8"	141	175	10
97710180	18	11/16"	145	228	10
97710200	20	25/32"	160	317	10
97710210	21	13/16"	160	313	5
97710240	24	15/16"	170	376	5
97710260	26	1.1/32"	170	376	5
97710270	27	1.1/16"	175	470	5
97710280	28	1.3/32"	175	470	2
97710290	29	1.1/8"	175	446	2
97710300	30	1.3/16"	190	575	2
97710400	40	1.9/16"	205	870	2
97710420	42		220	1046	1
97710450	45	1.3/4"	220	1014	1
97710550	55		240	1850	1
97710600	60		260	1850	1
97710650	65		260	3650	1
97710700	70	2.3/4"	300	3650	1
97710750	75		300	4300	1
97710900	90		345	5150	1

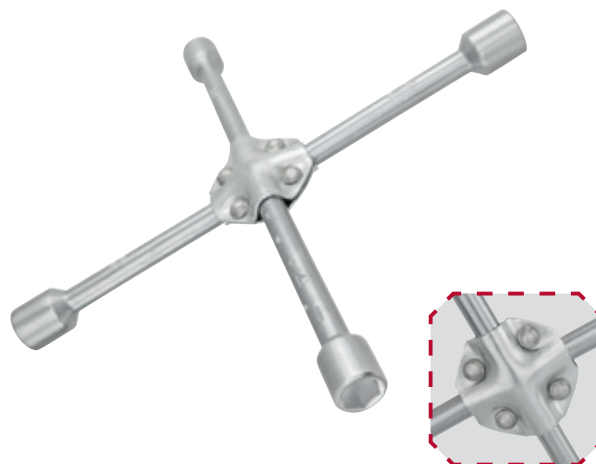
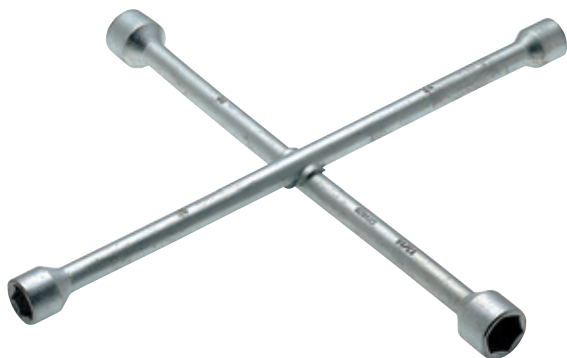

9475

KREUZSCHLÜSSEL FÜR PKW
4-WAY WHEEL WRENCH FOR CARS

Spezial-Werkzeugstahl
gehärtet, lackiert

Special Carbon steel
hardened, lacquered

Art.-No.	⌀mm	l-mm-l	g	📦
9244079	17 x 19 x 22 x 32	380	1350	1
9244090	17 x 19 x 21 x 1/2"	380	1350	1

9477

KREUZSCHLÜSSEL FÜR PKW
4-WAY WHEEL WRENCH FOR CARS

Spezial-Werkzeugstahl
verzinkt
mit verstärktem Mittelkreuz

Special Carbon steel
zinc plated
with enforcement

Art.-No.	⌀mm	l-mm-l	g	📦
9244089	17 x 19 x 13/16" x 22	356	1500	1

9476

KREUZSCHLÜSSEL FÜR LKW
4-WAY WHEEL WRENCH FOR TRUCKS

Spezial-Werkzeugstahl
gehärtet, lackiert

Special Carbon steel
hardened, lacquered



Art.-No.	⌀mm	l-mm-l	g	📦
947630323	24 x 27 x 30 x 32	700	5000	1
947632383	24 x 27 x 32 x 38	700	5116	1
9243150	24 x 27 x 32 x 3/4"	700	4000	1





9393

MUTTERNSPRENGER NUT SPLITTER

Spezial-Werkzeugstahl
verchromt

Special Carbon steel
chrome plated



Art.-No.	No.		l-mm-l		
93930273	3	13-24	148	370	10

9866

BANDSCHLÜSSEL STRAP WRENCH

rutschfestes Gewebeband
Spezial-Werkzeugstahl
vernickelt
Kunststoffgriff

anti-slip textile strap
Special Carbon steel
nickel plated
plastic handle

Art.-No.	Spannweite (mm) Capacity (mm)	l-mm-l		
9204300	140	200	177	1





415

STAHL-DRAHTBÜRSTE STEEL WIRE BRUSH

gehärteter und angelassener
Stahldrahtbesatz
solider Griff aus Holz mit
Aufhängeloch

hardened and tempered
steel wire bristles
solid wooden handle with
hanging hole



Art.-No.	Reihen Rows	 mm		
4150030	3	295	113	5
9200350	4	295	288	5
4150050	5	295	161	5



9414

ZIMMERMANN'SBLEISTIFT
CARPENTER'S PENCIL

oval oval

Art.-No.	l-mm-l		
9211890	175	10	1

9416

ZOLLSTOCK
FOLDING RULE

Holz wood

Art.-No.	l-mm-l		
9203990	2000 / 2 m	96	1

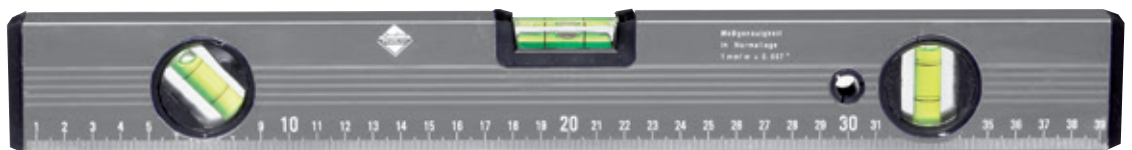

9419

WASSERWAAGE
WATER LEVEL

Aluminium lackiert Aluminium lacquered

Art.-No.	l-mm-l		
9242650	400	146	1



9700

SCHLOSSERHAMMER, DIN 1041
MACHINIST'S HAMMER, DIN 1041

VPA-GS geprüft
Hammerkopf geschmiedet
Hickorystiel

VPA-GS tested
forged head
hickory handle

Art.-No.	g	l-mm-i	g	g
9250390	100	260	150	1
9250400	200	280	250	1
9250410	300	300	400	1
9250420	400	310	550	1
9247250	500	320	620	1
9250430	600	340	700	1
9250150	800	350	950	1
9250440	1000	360	1200	1
9250450	1500	380	1600	1
9250460	2000	400	2200	1



9935

HANDFÄUSTEL, DIN 6475
MINING SLEDGE HAMMER, DIN 6475

VPA-GS geprüft
Hammerkopf geschmiedet
Hickorystiel

VPA-GS tested
forged head
hickory handle

Art.-No.	g	l-mm-i	g	g
99351000	1000	260	1100	2
99351250	1250	260	1310	2
99351500	1500	280	1550	2
99352000	2000	300	2150	1



9947

LATTHAMMER
ROOFING HAMMER

VPA-GS geprüft
Spezial-Werkzeugstahl
Kunststoffheft

VPA-GS tested
Special Carbon steel
plastic handle

Art.-No.	g	l-mm-i	g	g
994706000	600	620	850	1



9984

BERLINER MAURERHAMMER
MASON'S HAMMER

VPA-GS geprüft
Spezial-Werkzeugstahl
Kunststoffheft

VPA-GS tested
Special Carbon steel
plastic handle

Art.-No.	g	l-mm-i	g	g
998409000	900	320	1080	1



9950

GUMMIHAMMER, DIN 5128 A
RUBBER HAMMER, DIN 5128 A

Eschenstiel

ash handle

Art.-No.	∅ mm	l mm	g	
9950540	54	330	284	2
9950640	64	340	556	2
9950740	74	390	802	2
9950900	90	370	1186	2



9725

METALLSÄGEBOGEN
HACKSAW

Hartholzheft
mit Sägeblatt

hard wood handle
with saw blade

Art.-No.	l mm	g	
9242780	300	196	1

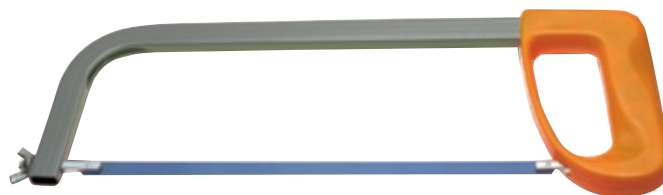

9727

METALLSÄGEBOGEN
HACKSAW

Kunststoffgriff
mit Sägeblatt

plastic handle
with saw blade

Art.-No.	l mm	g	
9224420	300	604	1

Vergleichstabelle für metrische, amerikanische und britische Schlüsselabmessungen

Comparative table for metric, american and british spanner dimensions

Schlüsselweiten Nominal Openings				Ø Gewinde Ø thread			Schlüsselweiten Nominal Openings		Ø Gewinde thread							Ø Gewinde Ø thread		Schlüsselweiten Nominal Openings		
									ISO R 272 1962			American Standard ASA B 18.2 - 1960								
Ø _{mm}	Minimum mm DIN ISO 691	Maximum mm DIN ISO 691 Toleranzklasse 1	Maximum mm DIN ISO 691 TK 2	ISO R 272 1962 Nuts	DIN 555/2 601/2	dezimal decimal		Schrauben Bolts	Muttern Nuts	Finished thick series	Regular Square series	Heavy Square series	Finished and regular bolt series hex. Head cap screws	Finished and heavy bolt series	BS 916 1083	dezimal decimal				
						"	mm									"	mm			
																		normaler Sechskant	kleiner Sechskant	Withworth
3	3,02	3,08																		
3,2	3,22	3,28		16		1/8	.1250	3,18	No.2						10		.117	2,97		
3,5	3,52	3,60		(17)										9		.131	3,33			
4	4,02	4,12		2		5/32	.1562	3,97	No.0 1					8		.152	3,86			
4,5	4,52	4,62		(2,3)		3/16	.1875	4,76	No.3	No.2 3				7		.172	4,37			
5	5,02	5,12		2,5		13/64	.2031	5,16	4 5					6		.193	4,90			
5,5	5,52	5,62		3		7/32	.2187	5,56						5		.220	5,59			
6	6,03	6,15		3,5		15/64	.2344	5,95						4		.248	6,30			
						1/4	.2500	6,35	No.6 8	No.4				1/16		.256	6,50			
7	7,03	7,15		4		17/64	.2656	6,75						3	3/16	.282	7,16			
						9/32	.2812	7,14						3/32		.297	7,54			
8	8,03	8,15	8,18	5		5/16	.3135	7,94	No.10 12	No.5 6				2		.324	8,23			
9	9,03	9,15	9,18		3/16	11/32	.3438	8,73		No.8				1/8		.340	8,64			
						3/8	.3750	9,52		No.8				1		.365	9,27			
10	10,04	10,15	10,24	6		13/32	.4062	10,32		10				0		.413	10,49			
11	11,04	11,19	11,24	7	1/4	7/16	.4375	11,11	1/4	No.12	1/4	1/4	1/4	3/16	1/4	.445	11,30			
						15/32		11,91												
12	12,04	12,24	12,30		8	1/2	.5000	12,70	5/16	1/4	5/16		5/16				13,43			
13	13,04	13,24	13,30	8		17/32	.5312	13,49		5/16				1/4	5/16	.525				
14	14,05	14,27	14,35		10	5/16	9/16	.5625	14,29			3/8	5/16	3/8						
15	15,05	15,27	15,35			19/32	.5938	15,08						5/16	3/8	.600	15,24			
16	16,05	16,27	16,35			5/8	.6250	15,88	7/16			3/8	7/16							
17	17,05	17,30	17,40	10	12	3/8	21/32	.6563	16,67					3/8	7/16	.710	18,03			
18	18,05	18,30	18,40			11/16	.6875	17,46		7/16	7/16		3/8							
19	19,06	19,36	19,46	12	14	7/16	3/4	.7500	19,05	1/2	1/2	7/16	7/16	1/2						
20	20,06	20,36	20,46		No.14	25/32	.7812	19,84						7/16	1/2	.820	20,83			
20,8	20,86	21,16	21,26			13/16	.8125	20,64	9/16			1/2	9/16							
21	21,06	21,36	24,46			7/8	.8750	22,22		9/16	9/16	9/16	1/2	1/2						
22	22,06	22,36	22,46	14	16	1/2	15/16	.9375	23,81	5/8	5/8	5/8		9/16	5/8					
23	23,06	23,36	23,46			31/32	.9688	24,61						1/2	9/16	.920	23,27			
24	24,06	24,36	24,46	16	18	1	1,0000	25,40				5/8								
25	25,06	25,36	25,46		No.18	11/16														
26	26,06	26,48	26,58				1,0625	26,99					5/8	5/8	9/16	5/8	5/8	1,010	25,65	
27	27,08	27,48	27,58	18	20	5/8								5/8	11/16	1,100	27,94			
28	28,08	28,48	28,58			11/8	1,1250	28,58	3/4	3/4	3/4	3/4		3/4						
29	29,08	29,48	29,58			13/16	1,1875	30,16						11/16	3/4	1,200	30,48			
30	30,08	30,48	20,58	20	22	11/4	1,2500	31,75					3/4	3/4						
32	32,08	32,48	32,58	22	24	3/4	15/16	1,3125	33,34	7/8	7/8	7/8	7/8		7/8	3/4	7/8	1,300	33,02	
33	33,08	33,48	33,58			13/8	1,3750	34,92						13/16	15/16	1,390	35,31			
36	36,10	36,6	36,70	24	27	7/8	1,7/16	1,4375	36,51				7/8	7/8						
38	38,10	38,6	38,70			11/2	1,5000	38,10	1	1	1	1	qa	1	7/8	1	1,480	37,59		
41	41,10	41,6	41,70	27	30	1	15/8	1,6250	41,28				1	1						
42	42,10	42,6	42,70			11/16	1,6875	42,86	11/8	11/8	11/8	11/8		11/8	1	11/8	1,670	42,42		
46	46,10	46,60	46,70	30	33	11/8	1,7500	44,45					11/8	11/8						
						13/4	1,8125	46,04												
						17/8	1,8750	47,62	11/4	11/4	11/4	11/4		11/4	11/4	11/4	1,860	47,24		
50	50,10	50,60	50,70	33	36	11/4	2	2,0000	50,80				11/4	11/4						
54	54,12	54,72	54,92			21/16	2,0625	52,39	13/8	13/8	13/8	13/8		13/8	11/4	13/8	2,050	52,07		
55	55,12	55,72	55,92	36	39	13/8	2,3/16	2,1875	55,56				13/8	13/8						
58	58,12	58,72	58,92			21/4	2,2500	57,15	11/2	11/2	11/2	11/2		13/8	11/2	2,220	56,39			
60	60,12	60,72	60,92	39		11/2	2,3/8	2,3750	60,32				11/2	11/2						
63	63,12	63,72	63,92			2,7/16	2,4375	61,91			15/8	15/8		15/8	11/2	15/8	2,410	61,21		
65	65,12	65,72	65,92	42		15/8	2,9/16	2,5625	65,09				15/8	15/8	15/8	15/8	13/4	2,580	65,35	
67	67,12	67,72	67,92			2,5/8	2,6250	66,68	13/4	13/4	13/4	13/4		13/4	15/8	15/8				
70	70,12	70,72	70,92	45		13/4	2,3/4	2,7500	69,85				13/4	13/4	13/4	2	2,760	70,10		
71	71,12	71,72	71,92			213/16	2,8125	71,44			17/8	17/8		17/8						
75	75,15	75,85	76,15	48		17/8	2,15/16	2,9375	74,61				17/8	17/8						
77	77,15	77,85	78,15			3	3,0000	76,20	2	2	2	2		2						
80	80,15	80,85	81,15	52		2	31/8	3,1250	79,38				2	2	2	21/4	3,150	80,01		
85	85,15	85,85	86,15	56		21/4	3,3/8	3,3750	85,72			21/4	21/4		21/4					
90	90,15	90,85	91,15	60		31/2	3,5000	88,90				21/4	21/4		21/4					
95	95,15	95,85	96,15	64		21/2	3,3/4	3,7500	95,25			21/2	21/2		21/2					
								3,8750	98,42				21/2	21/2		23/4	3,890	98,81		
100	100,20	100,90	101,20	68			3,7/8													

 Zündkerze sparking plug

[...] keine no ISO R 272 1962

Anzugswerte und Vorspannkraft

torque values and pretention forces

Schraubengröße bolt size		Güteklasse quality of bolts											
Gewinde thread	Schlüssel- weite acrossflat	3,6 (4 D)		5,6 (5 D)		6,9 (6 G)		8,8 (8 G)		10,9 (10 K)		12,9 (12 K)	
		PV N	M _A Nm	PV N	M _A Nm	PV N	M _A Nm	PV N	M _A Nm	PV N	M _A Nm	PV N	M _A Nm
M 2	4	284	0,12	378	0,16	731	0,31	863	0,37	1216	0,52	1461	0,63
M 2,3	4,5	407	0,20	544	0,26	1049	0,51	1245	0,60	1755	0,84	2099	1,01
M 2,6	5	525	0,28	701	0,37	1353	0,73	1598	0,86	2246	1,21	2697	1,45
M 3	5,5	726	0,44	966	0,59	1863	1,13	2207	1,34	3109	1,88	3727	2,26
M 3,5	6	971	6,8	1294	0,90	2501	1,74	2962	2,06	4168	2,89	5001	3,48
M 4	7	1255	1	1677	1,34	3226	2,6	3825	3,04	5374	4,31	6453	5,15
M 5	8 · 9	2059	1,96	2736	2,65	5286	5,10	6257	6,03	8806	8,48	10591	10,2
M 6	10	2903	3,43	3864	4,51	7453	8,73	8836	10,3	12405	14,71	14906	17,65
M 7	10 · 12	4237	5,59	5649	7,45	10885	14,22	12945	17,16	18191	24,52	21771	28,44
M 8	13 · 14	5315	8,24	7090	10,79	13680	21,57	16230	25,50	22752	35,30	27361	42,17
M10	15 · 16 · 17	8473	16,67	11278	21,57	21771	42,17	25792	50,01	36285	70,61	43542	85,32
M12	18 · 19 · 20	12356	28,44	16475	38,25	31773	73,55	37658	87,28	52956	122,58	63547	147,10
M 14	21 · 22 · 23	16966	45,11	22654	60,8	43640	116,7	51681	138,27	72688	194,17	87280	235,36
M 16	24 · 25 · 26	23340	69,63	31087	93,16	60017	178,48	71197	210,84	100028	299,10	120132	357,94
M 18	27 · 28	28341	95,13	37854	127,49	72962	245,17	86495	289,3	121603	411,88	146120	490,34
M 20	30	36481	135,33	48641	180,44	93850	348,14	111306	411,88	156417	578,50	187798	696,28
M 22	32 · 34	45601	182,4	60802	245,17	117190	470,72	139255	558,98	195644	784,54	234380	941,44
M 24	36	52564	230,46	70020	308,91	135333	598,21	160340	710,99	225554	1000,28	270665	1196,42
M 27	41	69235	342,23	92281	460,92	177992	887,51	210844	1049,32	296163	1480,81	355984	1775,01
M 30	46	84044	465,82	112287	622,73	215748	1206,23	255955	1421,97	359906	2010,38	432476	2402,64
M 33	50	104932	632,52	139746	848,28	269685	1627,91	319699	1931,92	449147	2716,46	539369	3265,63
M 36	55	123074	813,96	164263	1088,54	316757	2098,64	374616	2481,10	527601	3491,19	632533	4197,27
M 39	60	148081	1059,12	197115	1412,17	380500	2716,46	451109	3226,41	633513	4530,70	761001	5442,72
M 42	65	169166	1304,29	225554	1745,59	435418	3363,70	515833	3991,33	725697	5609,44	870836	6727,40
M 45	70	198096	1637,72	264781	2177,09	509949	4207,08	604093	4991,62	850242	7011,80	1019899	8414,16
M 48	75	222612	1980,96	297143	2638,00	573693	6060,55	679605	6021,32	956154	8473,00	1147385	10149,94
M 52	80	267723	2539,94	356964	3393,12	688431	6541,08	815918	7747,30	1147385	10885,45	1377843	13091,96
M 56	85	308911	3167,57	411882	4226,69	793363	8149,38	940463	9649,80	1323906	13582,29	1588687	16279,14
M 60	90	360887	3932,49	481509	5246,59	927715	10100,91	1098351	11964,19	1544557	16867,54	1853468	20201,82
M 64	95	407959	4736,64	544272	6305,71	1049318	12160,32	1245452	14415,86	1750498	20299,89	2098636	24320,64
M 68	100	466017	5788	622110	7727	1198976	14891	1420672	17645	1997539	24809	2396691	29754
M 72	105	526881	6913	703360	9228	1355568	17785	1606220	21074	2258427	29631	2708578	35537
M 76	110	599212	8275	799919	11047	1541663	21290	1826725	25227				
M 80	115	671179	9625	895991	12849	1726819	24763	2046118	29341				
M 90	130	868630	14098	1536700	24941	2234824	36271	2648055	42978				
M 100	145	1091415	19613	1656985	26182	2808008	50460	3327225	59790				
M 110	155	1339625	26391	1788335	35230	3446609	67898	4083906	80453				
M 120	175	1613269	34588	2153636	46174	4150644	88990						
M 130	185	1911957	443000	2553238	59159	4920786	114015						
M 140	200	2237179	55706	3115172	77568	5755849	143321						
M 150	210	2586543	68906	3452910	91986	6654699	177281						

Allgemeine Verkaufsbedingungen

Westfälische Gesenkschmiede GmbH
Schützenstraße 26-28
58339 Breckerfeld

§ 1 Allgemeines, Geltungsbereich

- Die vorliegenden Allgemeinen Verkaufsbedingungen (AVB) gelten für alle unsere Geschäftsbeziehungen mit unseren Kunden (nachfolgend: „Käufer“). Die AVB gelten nur, wenn der Käufer Unternehmer (§ 14 BGB), eine juristische Person des öffentlichen Rechts oder ein öffentlich-rechtliches Sondervermögen ist.
- Die AVB gelten insbesondere für Verträge über den Verkauf und/oder die Lieferung beweglicher Sachen (im Folgenden auch: „Ware“), ohne Rücksicht darauf, ob wir die Ware selbst herstellen oder bei Zulieferern einkaufen (§§ 433, 651 BGB). Die AVB gelten in ihrer jeweiligen Fassung als Rahmenvereinbarung auch für künftige Verträge über den Verkauf und/oder die Lieferung beweglicher Sachen mit demselben Käufer, ohne dass wir in jedem Einzelfall wieder auf sie hinweisen müssten.
- Unsere AVB gelten ausschließlich. Abweichende, entgegenstehende oder ergänzende Allgemeine Geschäftsbedingungen des Käufers werden nur dann und insoweit Vertragsbestandteil, als wir ihrer Geltung ausdrücklich zugestimmt haben. Dieses Zustimmungserfordernis gilt in jedem Fall, beispielsweise auch dann, wenn wir in Kenntnis der AGB des Käufers die Lieferung an ihn vorbehaltlos ausführen.
- Im Einzelfall getroffene, individuelle Vereinbarungen mit dem Käufer (einschließlich Nebenabreden, Ergänzungen und Änderungen) haben in jedem Fall Vorrang vor diesen AVB. Für den Inhalt derartiger Vereinbarungen ist ein schriftlicher Vertrag bzw. unsere schriftliche Bestätigung maßgebend.
- Rechtserhebliche Erklärungen und Anzeigen, die nach Vertragsschluss vom Käufer uns gegenüber abzugeben sind (z.B. Fristsetzungen, Mängelanzeigen, Erklärung von Rücktritt oder Minderung), bedürfen zu ihrer Wirksamkeit der Schriftform.
- Hinweise auf die Geltung gesetzlicher Vorschriften haben nur klarstellende Bedeutung. Auch ohne eine derartige Klarstellung gelten daher die gesetzlichen Vorschriften, soweit sie in diesen AVB nicht unmittelbar abgeändert oder ausdrücklich ausgeschlossen werden.

§ 2 Vertragsschluss

- Unsere Angebote sind freibleibend und unverbindlich. Dies gilt auch, wenn wir dem Käufer Kataloge, technische Dokumentationen (z.B. Zeichnungen, Pläne, Berechnungen, Kalkulationen, Verweisungen auf DIN), sonstige Produktbeschreibungen oder Unterlagen – auch in elektronischer Form – überlassen haben, an denen wir uns Eigentums- und Urheberrechte vorbehalten.
- Die Bestellung der Ware durch den Käufer gilt als verbindliches Vertragsangebot. Sofern sich aus der Bestellung nichts anderes ergibt, sind wir berechtigt, dieses Vertragsangebot innerhalb von 2 Wochen nach seinem Zugang bei uns anzunehmen.
- Die Annahme kann entweder schriftlich (z.B. durch Auftragsbestätigung) oder durch Auslieferung der Ware und zeitgleicher Rechnungslegung an den Käufer erklärt werden.

§ 3 Lieferfrist und Lieferverzug

- Die Lieferfrist wird individuell vereinbart bzw. von uns bei Annahme der Bestellung angegeben. Sollte die Lieferfrist bei Annahme der Bestellung noch nicht angegeben werden können, wir sie innerhalb von 14 Tagen nachgereicht.
- Sofern wir verbindliche Lieferfristen aus Gründen, die wir nicht zu vertreten haben, nicht einhalten können (Nichtverfügbarkeit der Leistung), werden wir den Käufer hierüber unverzüglich informieren und gleichzeitig die voraussichtliche, neue Lieferfrist mitteilen. Ist die Leistung auch innerhalb der neuen Lieferfrist nicht verfügbar, sind wir berech-

tigt, ganz oder teilweise vom Vertrag zurückzutreten; eine bereits erbrachte Gegenleistung des Käufers werden wir unverzüglich erstatten. Als Fall der Nichtverfügbarkeit der Leistung in diesem Sinne gilt insbesondere die nicht rechtzeitige Selbstbelieferung durch unseren Zulieferer, wenn wir ein kongruentes Deckungsgeschäft abgeschlossen haben. Unsere gesetzlichen Rücktritts- und Kündigungsrechte sowie die gesetzlichen Vorschriften über die Abwicklung des Vertrags bei einem Ausschluss der Leistungspflicht (z.B. Unmöglichkeit oder Unzumutbarkeit der Leistung und/oder Nacherfüllung) bleiben unberührt. Unberührt bleiben auch die Rücktritts- und Kündigungsrechte des Käufers gem. § 8 dieser AVB.

- Der Eintritt unseres Lieferverzugs bestimmt sich nach den gesetzlichen Vorschriften. In jedem Fall ist aber eine Mahnung durch den Käufer erforderlich.

§ 4 Lieferung, Gefahrübergang, Abnahme, Annahmeverzug

- Die Lieferung erfolgt ab Lager, wo auch der Erfüllungsort ist. Auf Verlangen und Kosten des Käufers wird die Ware an einen anderen Bestimmungsort versandt (Versendungskauf). Soweit nicht etwas anderes vereinbart ist, sind wir berechtigt, die Art der Versendung (insbesondere Transportunternehmen, Versandweg, Verpackung) selbst zu bestimmen.
- Die Gefahr des zufälligen Untergangs und der zufälligen Verschlechterung der Ware geht spätestens mit der Übergabe auf den Käufer über. Beim Versendungskauf geht jedoch die Gefahr des zufälligen Untergangs und der zufälligen Verschlechterung der Ware sowie die Verzögerungsgefahr bereits mit Auslieferung der Ware an den Spediteur, den Frachtführer oder der sonst zur Ausführung der Versendung bestimmten Person oder Anstalt über. Soweit eine Abnahme vereinbart ist, ist diese für den Gefahrübergang maßgebend. Auch im Übrigen gelten für eine vereinbarte Abnahme die gesetzlichen Vorschriften des Werkvertragsrechts entsprechend. Der Übergabe bzw. Abnahme steht es gleich, wenn der Käufer im Verzug der Annahme ist.
- Kommt der Käufer in Annahmeverzug, unterlässt er eine Mitwirkungshandlung oder verzögert sich unsere Lieferung aus anderen, vom Käufer zu vertretenden Gründen, so sind wir berechtigt, Ersatz des hieraus entstehenden Schadens einschließlich Mehraufwendungen (z.B. Lagerkosten) zu verlangen. Hierfür berechnen wir eine pauschale Entschädigung i.H.v. 1 % des Nettopreises pro Woche, beginnend mit der Lieferfrist bzw. - mangels einer Lieferfrist – mit der Mitteilung der Versandbereitschaft der Ware. Der Nachweis eines höheren Schadens und unsere gesetzlichen Ansprüche (insbesondere Ersatz von Mehraufwendungen, angemessene Entschädigung, Kündigung) bleiben unberührt; die Pauschale ist aber auf weitergehende Geldansprüche anzurechnen. Dem Käufer bleibt der Nachweis gestattet, dass uns überhaupt kein oder nur ein wesentlich geringerer Schaden als vorstehende Pauschale entstanden ist.
- Innerhalb einer Toleranz von 10 Prozent der Gesamtauftragsmenge sind fertigungsbedingte Mehr- oder Minderlieferungen zulässig. Ihrem Umfang entsprechend ändert sich dadurch der Gesamtpreis.

§ 5 Preise und Zahlungsbedingungen

- Sofern im Einzelfall nichts anderes vereinbart ist, gelten unsere jeweils zum Zeitpunkt des Vertragsschlusses aktuellen Preise, und zwar ab Lager, zzgl. gesetzlicher Umsatzsteuer.
- Beim Versendungskauf (§ 4 Abs. 1) trägt der Käufer die Transportkosten ab Lager und die Kosten

einer ggf. vom Käufer gewünschten Transportversicherung. Sofern wir nicht die im Einzelfall tatsächliche entstandenen Transportkosten in Rechnung stellen, gilt eine Transportkostenpauschale (ausschließlich Transportversicherung) i.H.v. 5 % des Nettopreises als vereinbart. Etwaige Zölle, Gebühren, Steuern und sonstige öffentliche Abgaben trägt der Käufer. Transport- und alle sonstigen Verpackungen nach Maßgabe der Verpackungsverordnung nehmen wir nicht zurück, sie werden Eigentum des Käufers; ausgenommen sind Paletten.

- Der Kaufpreis ist fällig und zu zahlen vorbehaltlich einer individuellen Vereinbarung innerhalb von 7 Tagen mit 3 % Skonto, 14 Tagen 2% Skonto oder 30 Tagen netto ab Rechnungsstellung und Lieferung bzw. Abnahme der Ware. Bei Verträgen mit einem Lieferwert von mehr als 10.000 EUR sind wir jedoch berechtigt, eine Anzahlung i.H.v. 25 % des Nettopreises zu verlangen. Die Anzahlung ist fällig und zu zahlen innerhalb von 7 Tagen ab Rechnungsstellung.
- Mit Ablauf vorstehender Zahlungsfrist kommt der Käufer in Verzug. Der Kaufpreis ist während des Verzugs zum jeweils geltenden gesetzlichen Verzugszinssatz zu verzinsen. Wir behalten uns die Geltendmachung eines weitergehenden Verzugschadens vor. Gegenüber Kaufleuten bleibt unser Anspruch auf den kaufmännischen Fälligkeitszins (§ 353 HGB) unberührt.
- Dem Käufer stehen Aufrechnungs- oder Zurückbehaltungsrechte nur insoweit zu, als sein Anspruch rechtskräftig festgestellt oder unbestritten ist. Bei Mängeln der Lieferung bleibt § 7 Abs. 6 unberührt.
- Wird nach Abschluss des Vertrags erkennbar, dass unser Anspruch auf den Kaufpreis durch mangelnde Leistungsfähigkeit des Käufers gefährdet wird (z.B. durch Antrag auf Eröffnung eines Insolvenzverfahrens), so sind wir nach den gesetzlichen Vorschriften zur Leistungsverweigerung und – gegebenenfalls nach Fristsetzung – zum Rücktritt vom Vertrag berechtigt (§ 321 BGB). Bei Verträgen über die Herstellung unvertretbarer Sachen (Einzelanfertigungen), können wir den Rücktritt sofort erklären; die gesetzlichen Regelungen über die Entbehrlichkeit der Fristsetzung bleiben unberührt.

§ 6 Eigentumsvorbehalt

- Bis zur vollständigen Bezahlung aller unserer gegenwärtigen und künftigen Forderungen aus dem Kaufvertrag und einer laufenden Geschäftsbeziehung (gesicherte Forderungen) behalten wir uns das Eigentum an den verkauften Waren vor.
- Die unter Eigentumsvorbehalt stehenden Waren dürfen vor vollständiger Bezahlung der gesicherten Forderungen weder an Dritte verpfändet, noch zur Sicherheit übereignet werden. Der Käufer hat uns unverzüglich schriftlich zu benachrichtigen, wenn und soweit Zugriffe Dritter auf die uns gehörenden Waren erfolgen.
- Bei vertragswidrigem Verhalten des Käufers, insbesondere bei Nichtzahlung des fälligen Kaufpreises, sind wir berechtigt, nach den gesetzlichen Vorschriften vom Vertrag zurückzutreten oder/und die Ware auf Grund des Eigentumsvorbehalts herauszuverlangen. Das Herausgabeverlangen beinhaltet nicht zugleich die Erklärung des Rücktritts; wir sind vielmehr berechtigt, lediglich die Ware herauszuverlangen und uns den Rücktritt vorzubehalten. Zahlt der Käufer den fälligen Kaufpreis nicht, dürfen wir diese Rechte nur geltend machen, wenn wir dem Käufer zuvor erfolglos eine angemessene Frist zur Zahlung gesetzt haben oder eine derartige Fristsetzung nach den gesetzlichen Vorschriften entbehrlich ist.

4. Der Käufer ist befugt, die unter Eigentumsvorbehalt stehenden Waren im ordnungsgemäßen Geschäftsgang weiter zu veräußern und/oder zu verarbeiten. In diesem Fall gelten ergänzend die nachfolgenden Bestimmungen.
- (a) Der Eigentumsvorbehalt erstreckt sich auf die durch Verarbeitung, Vermischung oder Verbindung unserer Waren entstehenden Erzeugnisse zu deren vollem Wert, wobei wir als Hersteller gelten. Bleibt bei einer Verarbeitung, Vermischung oder Verbindung mit Waren Dritter deren Eigentumsrecht bestehen, so erwerben wir Miteigentum im Verhältnis der Rechnungswerte der verarbeiteten, vermischten oder verbundenen Waren. Im Übrigen gilt für das entstehende Erzeugnis das Gleiche wie für die unter Eigentumsvorbehalt gelieferte Ware.
- (b) Die aus dem Weiterverkauf der Ware oder des Erzeugnisses entstehenden Forderungen gegen Dritte tritt der Käufer schon jetzt insgesamt bzw. in Höhe unseres etwaigen Miteigentumsanteils gemäß vorstehendem Absatz zur Sicherheit an uns ab. Wir nehmen die Abtretung an. Die in Abs. 2 genannten Pflichten des Käufers gelten auch in Ansehung der abgetretenen Forderungen.
- (c) Zur Einziehung der Forderung bleibt der Käufer neben uns ermächtigt. Wir verpflichten uns, die Forderung nicht einzuziehen, solange der Käufer seinen Zahlungsverpflichtungen uns gegenüber nachkommt, nicht in Zahlungsverzug gerät, kein Antrag auf Eröffnung eines Insolvenzverfahrens gestellt ist und kein sonstiger Mangel seiner Leistungsfähigkeit vorliegt. Ist dies aber der Fall, so können wir verlangen, dass der Käufer uns die abgetretenen Forderungen und deren Schuldner bekannt gibt, alle zum Einzug erforderlichen Angaben macht, die dazugehörigen Unterlagen aushändigt und den Schuldnern (Dritten) die Abtretung mitteilt.
- (d) Übersteigt der realisierbare Wert der Sicherheiten unsere Forderungen um mehr als 10%, werden wir auf Verlangen des Käufers Sicherheiten nach unserer Wahl freigeben.

§ 7 Mängelansprüche des Käufers

- Für die Rechte des Käufers bei Sach- und Rechtsmängeln (einschließlich Falsch- und Minderlieferung sowie unsachgemäßer Montage oder mangelhafter Montageanleitung) gelten die gesetzlichen Vorschriften, soweit im nachfolgenden nichts anderes bestimmt ist. In allen Fällen unberührt bleiben die gesetzlichen Sondervorschriften bei Endlieferung der Ware an einen Verbraucher (Lieferantenregress gem. §§ 478, 479 BGB).
- Grundlage unserer Mängelhaftung ist vor allem die über die Beschaffenheit der Ware getroffene Vereinbarung. Als Vereinbarung über die Beschaffenheit der Ware gelten alle Produktbeschreibungen, die Gegenstand des einzelnen Vertrages sind; es macht hierbei keinen Unterschied, ob die Produktbeschreibung vom Käufer, vom Hersteller oder von uns stammt.
- Soweit die Beschaffenheit nicht vereinbart wurde, ist nach der gesetzlichen Regelung zu beurteilen, ob ein Mangel vorliegt oder nicht (§ 434 Abs. 1 S. 2 und 3 BGB). Für öffentliche Äußerungen des Herstellers oder sonstiger Dritter (z.B. Werbeausagen) übernehmen wir jedoch keine Haftung.
- Die Mängelansprüche des Käufers setzen voraus, dass er seinen gesetzlichen Untersuchungs- und Rückgepflichten (§§ 377, 381 HGB) nachgekommen ist. Zeigt sich bei der Untersuchung oder später ein Mangel, so ist uns hiervon unverzüglich schriftlich Anzeige zu machen. Als unverzüglich gilt die Anzeige, wenn sie innerhalb von zwei Wochen erfolgt, wobei zur Fristwahrung die rechtzeitige Absendung der Anzeige genügt. Unabhängig von dieser Untersuchungs- und Rückgepflicht hat der

Käufer offensichtliche Mängel (einschließlich Falsch- und Minderlieferung) innerhalb von zwei Wochen ab Lieferung schriftlich anzuzeigen, wobei auch hier zur Fristwahrung die rechtzeitige Absendung der Anzeige genügt. Versäumt der Käufer die ordnungsgemäße Untersuchung und/oder Mängelanzeige, ist unsere Haftung für den nicht angezeigten Mangel ausgeschlossen.

- Ist die gelieferte Sache mangelhaft, können wir zunächst wählen, ob wir Nacherfüllung durch Beseitigung des Mangels (Nachbesserung) oder durch Lieferung einer mangelfreien Sache (Ersatzlieferung) leisten. Unser Recht, die gewählte Art der Nacherfüllung unter den gesetzlichen Voraussetzungen zu verweigern, bleibt unberührt.
- Wir sind berechtigt, die geschuldete Nacherfüllung davon abhängig zu machen, dass der Käufer den fälligen Kaufpreis bezahlt. Der Käufer ist jedoch berechtigt, einen im Verhältnis zum Mangel angemessenen Teil des Kaufpreises zurückzubehalten.
- Der Käufer hat uns die zur geschuldeten Nacherfüllung erforderliche Zeit und Gelegenheit zu geben, insbesondere die beanstandete Ware zu Prüfungszwecken zu übergeben. Im Falle der Ersatzlieferung hat uns der Käufer die mangelhafte Sache nach den gesetzlichen Vorschriften zurückzugeben.
- Die zum Zweck der Prüfung und Nacherfüllung erforderlichen Aufwendungen, insbesondere Transport-, Wege-, Arbeits- und Materialkosten, tragen wir, wenn tatsächlich ein Mangel vorliegt. Stellt sich jedoch ein Mangelbeseitigungsverlangen des Käufers als unberechtigt heraus, können wir die hieraus entstandenen Kosten vom Käufer ersetzt verlangen.
- In dringenden Fällen, z.B. bei Gefährdung der Betriebssicherheit oder zur Abwehr unverhältnismäßiger Schäden, hat der Käufer das Recht, den Mangel selbst zu beseitigen und von uns Ersatz der hierzu objektiv erforderlichen Aufwendungen zu verlangen. Von einer derartigen Selbstvornahme sind wir unverzüglich, nach Möglichkeit vorher, zu benachrichtigen. Das Selbstvornahmerecht besteht nicht, wenn wir berechtigt wären, eine entsprechende Nacherfüllung nach den gesetzlichen Vorschriften zu verweigern.
- Wenn die Nacherfüllung fehlgeschlagen ist oder eine für die Nacherfüllung vom Käufer zu setzende angemessene Frist erfolglos abgelaufen oder nach den gesetzlichen Vorschriften entbehrlich ist, kann der Käufer vom Kaufvertrag zurücktreten oder den Kaufpreis mindern. Bei einem unerheblichen Mangel besteht jedoch kein Rücktrittsrecht.
- Ansprüche des Käufers auf Schadensersatz bzw. Ersatz vergeblicher Aufwendungen bestehen nur nach Maßgabe von § 8 und sind im Übrigen ausgeschlossen.

§ 8 Sonstige Haftung

- Soweit sich aus diesen AVB einschließlich der nachfolgenden Bestimmungen nichts anderes ergibt, haften wir bei einer Verletzung von vertraglichen und außervertraglichen Pflichten nach den Werbeauseinschlägigen gesetzlichen Vorschriften.
- Auf Schadensersatz haften wir – gleich aus welchem Rechtsgrund – bei Vorsatz und grober Fahrlässigkeit. Bei einfacher Fahrlässigkeit haften wir nur
 - für Schäden aus der Verletzung des Lebens, des Körpers oder der Gesundheit,
 - für Schäden aus der Verletzung einer wesentlichen Vertragspflicht (Verpflichtung, deren Erfüllung die ordnungsgemäße Durchführung des Vertrags überhaupt erst ermöglicht und auf deren Einhaltung der Vertragspartner regelmäßig vertraut und vertrauen darf); in diesem Fall ist

unsere Haftung jedoch auf den Ersatz des vorhersehbaren, typischerweise eintretenden Schadens begrenzt.

- Die sich aus Abs. 2 ergebenden Haftungsbeschränkungen gelten nicht, soweit wir einen Mangel arglistig verschwiegen oder eine Garantie für die Beschaffenheit der Ware übernommen haben. Das gleiche gilt für Ansprüche des Käufers nach dem Produkthaftungsgesetz.
- Wegen einer Pflichtverletzung, die nicht in einem Mangel besteht, kann der Käufer nur zurücktreten oder kündigen, wenn wir die Pflichtverletzung zu vertreten haben. Ein freies Kündigungsrecht des Käufers (insbesondere gem. §§ 651, 649 BGB) wird ausgeschlossen. Im Übrigen gelten die gesetzlichen Voraussetzungen und Rechtsfolgen.

§ 9 Verjährung

- Abweichend von § 438 Abs. 1 Nr. 3 BGB beträgt die allgemeine Verjährungsfrist für Ansprüche aus Sach- und Rechtsmängeln ein Jahr ab Ablieferung. Soweit eine Abnahme vereinbart ist, beginnt die Verjährung mit der Abnahme.
- Die vorstehende Verjährungsfrist des Kaufrechts gilt auch für vertragliche und außervertragliche Schadensersatzansprüche des Käufers, die auf einem Mangel der Ware beruhen, es sei denn die Anwendung der regelmäßigen gesetzlichen Verjährung (§§ 195, 199 BGB) würde im Einzelfall zu einer kürzeren Verjährung führen. Die Verjährungsfristen des Produkthaftungsgesetzes bleiben in jedem Fall unberührt. Ansonsten gelten für Schadensersatzansprüche des Käufers gem. § 8 ausschließlich die gesetzlichen Verjährungsfristen.

§ 10 Rechtswahl und Gerichtsstand

- Für diese AVB und alle Rechtsbeziehungen zwischen uns und dem Käufer gilt das Recht der Bundesrepublik Deutschland unter Ausschluss aller internationalen und supranationalen (Vertrags-) Rechtsordnungen, insbesondere des UN-Kaufrechts. Voraussetzungen und Wirkungen des Eigentumsvorbehalts gem. § 6 unterliegen hingegen dem Recht am jeweiligen Lageort der Sache, soweit danach die getroffene Rechtswahl zugunsten des deutschen Rechts unzulässig oder unwirksam ist.
- Ist der Käufer Kaufmann i.S.d. Handelsgesetzbuchs, juristische Person des öffentlichen Rechts oder ein öffentlich-rechtliches Sondervermögen, ist ausschließlicher – auch internationaler – Gerichtsstand für alle sich aus dem Vertragsverhältnis unmittelbar oder mittelbar ergebenden Streitigkeiten unserer Geschäftssitz in Breckerfeld. Wir sind jedoch auch berechtigt, Klage am allgemeinen Gerichtsstand des Käufers zu erheben.

Breckerfeld, 01. Mai 2020

General Terms and Conditions of Sale

Westfälische Gesenkschmiede GmbH
Schützenstraße 26-28
58339 Breckerfeld

Section 1 General, Scope

1. The present General Terms and Conditions of Sale ("Terms") apply for all our business relationships with our customers (hereinafter: "Buyer"). The Terms only apply if the Buyer is an entrepreneur (Section 14 BGB), a legal entity under public law or a special fund under public law.
2. The Terms apply in particular for contracts concerning the sale and/or delivery of moveable items (hereinafter also: "Goods"), regardless of whether we produce the goods themselves or procure them from suppliers (Sections 433, 651 BGB). The Terms also apply in their respective valid version as a framework agreement for future contracts concerning the sale and/or delivery of moveable items with the same Buyer, without requiring us to refer to them in each individual case.
3. Our Terms apply exclusively. Deviating, conflicting or complementary General Terms and Conditions of the Buyer will only become integral parts of the contract if and insofar as we have expressly approved their validity. This requirement of approval applies in all cases, for instance even if we carry out delivery to the Buyer without reservation despite being aware of the Buyer's General Terms and Conditions.
4. Individual agreements reached with the Buyer in specific cases (including ancillary agreements, additions and changes) have priority over these Terms in any case. The content of such agreements is determined by a written contract or our written confirmation.
5. Legally significant declarations and notifications that the Buyer makes to us after conclusion of contract (e.g. setting deadlines, reporting defects, declaring withdrawal or reduction) must be made in writing to be effective.
6. References to the validity of statutory regulations are only provided for the purpose of clarification. Therefore, the statutory regulations also apply without such clarification unless they are directly modified or expressly excluded in these Terms.

Section 2 Contract Conclusion

1. Our offers are voluntary and non-binding. This applies even if we provide the Buyer with catalogues, technical documentation (e.g. drawings, plans, estimates, calculations, DIN references), other product descriptions or documents – including in electronic form – to which we retain property rights and copyrights.
2. The order placed by the Buyer for the goods is considered a binding contractual offer. Unless stipulated otherwise in the order, we are entitled to accept this contractual offer within 2 weeks after we have received it.
3. Acceptance can be declared either in writing (e.g. order confirmation) or by delivery of the goods and simultaneous invoicing to the Buyer.

Section 3 Delivery Period and Default in Delivery

1. The delivery period is agreed individually or indicated by us upon accepting the order. If it is not possible to indicate the delivery period upon accepting the order, it will be given later within 14 days.
2. If we are unable to comply with binding delivery periods for reasons outside our responsibility (non-availability of service), we will inform the Buyer promptly of these circumstances and at the same time communicate a provisional new period for delivery. If the service is still unavailable within the new delivery period, we are entitled to withdraw from the contract entirely or in part; we will promptly reimburse any services in return that have already been performed by the Buyer. In this context, non-availability of service particularly applies in case of late self-delivery from our

suppliers if we have concluded a congruent hedging transaction. Our legal rights of withdrawal and termination as well as the legal regulations concerning the settlement of contracts when the obligation to perform is excluded (e.g. if the service and/or subsequent performance is impossible or unreasonable) shall remain unaffected. The Buyer's rights of withdrawal and termination pursuant to Section 8 of these Terms also remain unaffected.

3. The occurrence of default in our delivery is determined according to the statutory provisions. In any case, a reminder from the Buyer is required.

Section 4 Delivery, Transfer of Risk, Acceptance, Default in Acceptance

1. The delivery is carried out ex-warehouse, which is also the place of fulfilment. At the request and expense of the Buyer, the goods can be sent to a different destination (shipment purchase). Unless otherwise agreed, we are entitled to determine the type of shipment (in particular the transport company, dispatch route, packaging) ourselves.
2. The risk of accidental destruction and accidental destruction of the goods is transferred to the Buyer upon delivery at the latest. However, in case of shipment purchase, the risk of accidental destruction and accidental destruction of the goods and the risk of delay is transferred upon dispatch of the goods to the forwarding agent, freight carrier or other person or institution charged with carrying out the shipment. If acceptance is agreed, the transfer of risk occurs upon acceptance. Apart from this, where acceptance is agreed, the statutory provisions of the law governing contracts for work and services shall apply. If the Buyer is in default of acceptance, this shall be equivalent to delivery or acceptance.
3. If the Buyer is in default of acceptance, fails to cooperate or if our delivery is delayed for other reasons for which the Buyer is responsible, we are entitled to demand compensation for the resulting damage including additional expenses (e.g. storage costs). In this regard, we will charge a flat-rate compensation amounting to 1% of the net price per week starting with the delivery deadline – or in the absence of a delivery deadline, upon notification of readiness for dispatch concerning the goods. The right to demonstrate higher damages and our statutory claims (in particular reimbursement for additional expenses, appropriate compensation, termination) remain unaffected; however, the flat-rate compensation will be offset against more extensive monetary claims. The Buyer is entitled to demonstrate that we have incurred no damages or significantly lower damages than the above flat-rate fee.
4. Production-related long or short deliveries are permitted within a tolerance of 10 per cent of the total order quantity. The total price will be adjusted accordingly.

Section 5 Prices and payment conditions

1. Unless otherwise agreed in the individual case, our current prices apply at the time the contract is established, ex warehouse, plus statutory VAT.
2. For shipment purchase (Section 4 [1]), the Buyer pays the transport costs ex warehouse and the cost of any transport insurance desired by the Buyer. If we do not bill the transport costs actually incurred in the individual case, a flat-rate transport fee (excluding transport insurance) amounting to 5% of the net price is agreed. Any customs duties, fees, taxes and other public charges will be paid by the Buyer. We do not take back transport packaging or any other packaging in line with the Packaging Ordinance [Verpackungsverordnung];

this becomes the property of the Buyer, excluding pallets.

3. The purchase price becomes due for payment, notwithstanding an individual agreement, within 7 days with 3% discount, within 14 days with 2% discount or within 30 days net after invoicing and delivery or acceptance of the goods. For contracts with a delivery value of more than 10,000 euros, however, we are entitled to demand advance payment amounting to 25% of the net price. The advance becomes due for payment within 7 days after invoicing.
4. After the above payment period has elapsed, the Buyer enters into default. The purchase price accrues interest during the period of default at the currently valid statutory default interest rate. We reserve the right to assert more extensive damages due to default. With respect to entrepreneurs, we reserve our entitlement to the commercial default interest rate (Section 353 HGB).
5. The Buyer is entitled to offset or withhold amounts only insofar as the Buyer's claim is legally established or undisputed. In case of defects in the delivery, Section 7 [6] remains unaffected.
6. If it becomes evident after concluding the contract that our claim to the purchase price is jeopardised due to the Buyer's inability to perform (e.g. application to initiate insolvency proceedings), we are entitled to refuse performance and withdraw from the contract – potentially after giving a notice period – according to the statutory provisions (Section 321 BGB). For contracts concerning the production of non-fungible goods (individual production), we can declare withdrawal immediately; the statutory regulations concerning whether a notice period is necessary remain unaffected.

Section 6 Reservation of title

1. Until complete payment of all our present and future claims resulting from the purchase agreement and an ongoing business relationship (secured claims) we reserve the ownership of the purchased goods.
2. The reserved goods may neither be assigned to third parties nor transferred as a security before complete payment of the secured claims. The Buyer must inform us promptly in writing if and insofar as third parties obtain access to the goods belonging to us.
3. If the Buyer acts in violation of the contract, particularly in case of failure to pay the due purchase price, we are entitled to withdraw from the contract and/or demand the surrender of the goods based on our reservation of title according to the statutory provisions. The request to surrender the goods does not automatically involve a declaration of withdrawal; we are entitled to only request the surrender of the goods and reserve our right of withdrawal. If the Buyer fails to pay the due purchase price, we can only assert these rights after we have set the Buyer an reasonable deadline for payment that has elapsed unsuccessfully, or such a deadline can be waived in accordance with the statutory provisions.
4. The Buyer is authorised to resell and/or process the reserved goods in the ordinary course of business. In this case, the following provisions apply additionally.
(a) The reservation of title extends to the full value of the products generated by processing, mixing or combining our goods, whereby we are considered the manufacturer. If third-party property rights are maintained when processing, mixing or combining with third-party goods, then we acquire co-ownership in proportion to the invoice values of the processed, mixed or combined goods. Apart from this, the same conditions apply for the crea-

ted product as for the goods delivered subject to reservation of title.

(b) As a security, the Buyer hereby assigns us all claims against third parties arising from the resale of the goods or the product in their entirety or in the amount of our co-ownership share according to the previous paragraph. We accept the assignment. The Buyer's obligations outlined in Paragraph 2 also apply with respect to the assigned claims.

(c) We and the Buyer are entitled to collect the claim. We agree to not collect the claim as long as the Buyer fulfils his payment obligations to us, does not enter into default of payment, no applications are filed to initiate insolvency proceedings and there are no other defects in the Buyer's ability to perform. However, if this is the case, we may request that the Buyer give us notice of the assigned claims and their debtors and for the Buyer to make all statements necessary for collection, hand over the accompanying documents and inform the debtors (third parties) of this assignment.

(d) If the realisable value of the securities exceeds our claims by more than 10%, we will release securities of our choice at the Buyer's request.

Section 7 Defect claims of the Buyer

1. The statutory provisions apply concerning the Buyer's rights in case of material and legal defects (including wrong delivery and short delivery, improper assembly or inadequate assembly instructions), unless otherwise stipulated in the following. In any case, the special statutory regulations concerning end delivery of the goods to a consumer (supplier recourse pursuant to Sections 478, 479 BGB) remain unaffected.
2. The basis of our liability for defects is primarily the agreement concerning the quality of the goods. All product descriptions that are the subject of the individual contracts shall be deemed agreements concerning the quality of the goods, irrespective of whether the product description originates from the Buyer, from the manufacturer or from us.
3. If there are no agreements concerning quality, the statutory regulations must be used to assess whether or not a defect is present (Section 434 [1] Sentence 2 and 3 BGB). However, we accept no liability for public statements of the manufacturer or other third parties (for instance, advertising messages).
4. The Buyer's defect claims will not be accepted unless he has fulfilled his statutory obligations to examine and notify of defects (Sections 377, 381 HGB). If a defect is detected during the examination or later, we must be informed in writing in a timely fashion. Notification is considered timely if it occurs within two weeks, whereby sending the notification on time is sufficient for meeting the deadline. Independently of this obligation to examine and notify of defects, the buyer must report evident defects (including wrong and short delivery) within a period of two weeks after delivery, whereby sending the notification on time is sufficient for meeting the deadline here as well. If the Buyer fails to perform proper examination and/or notification of defects, we are not liable for defects that were not reported.
5. If the delivered goods are defective, we may first choose whether to provide subsequent performance by eliminating the defect (repair) or by delivering non-defective goods (replacement). Our right to reject the chosen method of subsequent performance under the statutory provisions remains unaffected.
6. We are entitled to make our subsequent performance conditional on the Buyer's payment of the purchase price owed. However, the Buyer

is entitled to withhold an appropriate part of the purchase price in proportion to the defect.

7. The Buyer must allow us the necessary time and opportunity for the subsequent performance owed, and in particular must hand over the defective goods for inspection purposes. In case of replacement, the Buyer must return the defective goods to us according to the statutory provisions
8. We will bear the expenses required for inspection and subsequent performance, in particular transport, route, labour and material costs if a defect actually exists. However, if the Buyer's request to eliminate defects proves to be unjustified, we can demand that the Buyer reimburse us for the costs incurred as a result.
9. In urgent cases, for instance endangerment to operational safety or to prevent disproportionate damages, the Buyer has the right to eliminate the defect himself and to request reimbursement from us for the expenses that are objectively required. We must be informed of this type of self-performance promptly, in advance where possible. The right to self-performance does not apply if we would be entitled to refuse the subsequent performance in question according to the statutory provisions.
10. If subsequent performance is not successful or the appropriate deadline set by the Buyer for subsequent performance has elapsed unsuccessfully or if this deadline is not required according to the statutory provisions, the Buyer may withdraw from the purchase agreement or reduce the purchase price. In case of insignificant defects, however, there is no right of withdrawal.
11. The Buyer's claims to damages or reimbursement of futile expenses only apply in line with Section 8 and are otherwise excluded.

Section 8 Other liability

1. Unless otherwise stipulated by these Terms including the following provisions, we shall be liable in case of infringement of contractual and non-contractual obligations according to the relevant statutory regulations.
2. We shall be liable for damages, regardless of the legal reason, in cases of willful intent and gross negligence. We shall only be liable for simple negligence
 - a) for damages resulting from injury to life, body or health,
 - b) for damages resulting from infringement of a cardinal contractual duty (obligations which must be fulfilled to allow proper performance of the contract and for which the contractual partner regularly can and does rely on compliance); in this case, our liability is restricted to compensation for foreseeable, typically occurring damages.
3. The limitations of liability resulting from Paragraph 2 shall not apply insofar as we maliciously conceal a defect or if we have issued a guarantee concerning the quality of the goods. The same applies for the Buyer's claims according to the Product Liability Act [Produkthaftungsgesetz].
4. The Buyer may only withdraw or terminate the contract due to a breach of duty that does not involve a defect if we are responsible for the breach of duty. A free right of termination for the Buyer (in particular in accordance with Sections 651, 649 BGB) is excluded. Otherwise, the statutory requirements and legal consequences apply.

Section 9 Limitation

1. By way of abrogation from Section 438 [1] No. 3 BGB, the general period of limitation for claims owing to material and legal defects is one year after delivery. Where acceptance has been agreed upon, the period of limitation starts upon acceptance.

2. The above limitation period under commercial law also applies for the Buyer's contractual and non-contractual damage claims based on a defect in the goods, unless the application of regular statutory limitation periods (Sections 195, 199 BGB) would lead to a shorter limitation period in the individual case. The limitation periods under the Product Liability Act remain unaffected in any case. Otherwise, the statutory limitation periods apply exclusively for the Buyer's damage claims in accordance with Section 8.

Section 10 Choice of law and place of jurisdiction

1. For these terms and all legal relations between us and the Buyer, the laws of the Federal Republic of Germany apply to the exclusion of all international and supra-national (contractual) legal systems, in particular the UN Contract on the International Sale of Goods. In contrast, the prerequisites and effects of the reservation of title according to Section 6 are subject to the laws of the respective storage location for the goods insofar as the choice of law made in favour of German law is inadmissible or invalid.
2. If the Buyer is an entrepreneur within the meaning of the Commercial Code, a legal entity under public law or a special fund under public law, the exclusive place of jurisdiction – even internationally – for all disputes arising directly or indirectly from this contractual relationship is our registered office in Breckerfeld. However, we are also entitled to file suite at the Buyer's general place of jurisdiction.

Breckerfeld, 01 May 2020





WGB[®]

Westfälische Gesenkschmiede GmbH

Schützenstraße 26 – 28
58339 Breckerfeld, Germany

t +49 (0) 2338 . 9199-0
f +49 (0) 2338 . 9199-100
m info@the-werkzeug.de

www.the-werkzeug.de

40
JAHRE

**INTENSIV
GARANTIE**